

## Centroid CNC12 v5.42.05 Release Notes 7-2-26

- v5.42.xx is FREE for all v5.4 License holders
- v5.42.xx works with older (v5.3 etc) licenses as well, you just don't get any new v5.42 features with a non v5.4 license. Bug fixes for CNC12 are always free so your old license will work with v5.42. Please spend a few bucks on a CNC12 License upgrade to v5.4 so you get the new features of v5.4 that will improve your work flow and help us to continue to improve CNC12. Read more about the industries fairest CNC software license policy here: [https://www.centroidcnc.com/centroid\\_diy/centroid\\_cnc\\_software\\_licensing.html](https://www.centroidcnc.com/centroid_diy/centroid_cnc_software_licensing.html)
- **Not sure what you version you have and what new is available for your controller hardware?** Use the free Centroid CNC12 License checker, this web page will let you know what new CNC software is available for your controller and present you with Add to Cart links. [https://shopcentroidcnc.com/cnc12\\_license/](https://shopcentroidcnc.com/cnc12_license/)
- It is now easy to purchase a CNC12 license file or a license file upgrade 24/7/365 directly on our web page [shopcentroidcnc.com](https://shopcentroidcnc.com), it is automatic and the license file will be emailed to you in minutes after the purchase.

### 1.) Major CNC12 Mill User Interface and User Experience (UI/UX) improvements

- Comprehensive Overhaul of CNC12 Mill Graphics/Text/Colors. All new part setup menu graphics, all new probing menu graphics, new touch probe and tool touch indicator graphics
- New features added such as: measure part zero position with a TT, Probe Stylus Calibration menu, TT indicator graphics in the Tool Offset menu, graphical tool check when in run time graphics mode, home program aware homing graphics, new indicator lights for limit switch tripped, smoothing on, keyboard jogging active, feed hold on, frequency modulation on, laser on, laser power modulation with velocity on, pwm mod on, spindle frequency modulation on,
- images are now transparent .pngs which work with most any background color, cnc12 images are user editable as well (if you wish you can change them to what ever you require :-)
- Improved Intercon Mill post processor for better posting of tool height offset in the G code which results in better G code backplots and RTG (eliminates unexpected lines below Z zero on the graph due to tool height offset values not being taken into account at the right time). Note: You can revert to the old Intercon Post processor if you like, to do that we Added a bit (+32) to machine parameter 3 (Modal Tool and Height Offset Control) to revert to the OLD Post processor so if for some reason you want to use the old one you still can.
- Added a new CNC12 Dashboard indicator light section
- Improvements to Mill Part Zero Setup Menus
- Added wizard support for @ and M axes
- Creation of Probe Stylus Calibration Menu

### 2.) CNC12 Lathe UI/UX improvements

- New improved Homing and other graphics
- Improved color controls for better contrast and UX in all lathe menus
- Introduced Tool Check Return to work more for Lathe can now be a non-Pythagorean movement when resuming a job (P59 bit 2) will move x axis first and then z axis if the tool is marked as ID. Vice versa otherwise

WCS #1 (G54) Job: shift\_fork.cnc

X +0.0000  
Y +0.0000  
Z +0.0000

Distance to Go  
X +0.0000  
Y +0.0000  
Z +0.0000

Spindle RPM:  
S: 0 A

Feedrate:  
100%  
0.0 ipm

20. N0002 T3 M6 Tool change: T3 1/2" end mill

Insert tool and press CYCLE START

View Crosshair Toggle F6 F7 G-Code F8 T-Shape Toggle F9 Show Tools F10

Acorn CNC

AUX 1 AUX 2 AUX 3 AUX 4

100% 25% 50% 75%

FAULT RESET

WCS #1 (G54) Current Position (Inches)

X +5.3750  
Y -6.1871  
Z +0.0000

Job: sample\_gusset.cnc  
Tool: T2 H2  
Feedrate: 100% 0.0 ipm  
Spindle: 0 A  
Rapid Rate: 100%

Program # 20000  
Part Cnt: 0  
Part #: 0  
Time: 0:00:34

302 Moving...  
303 Paused...  
302 Moving...  
302 Moving...  
307 Operator abort: job cancelled

Set Part 0/Position

- 1.) Position Tool/TT
- 2.) Enter TT Height
- 3.) Enter Part Position
- 4.) Press Cycle Start to Seek the TT

Axis Part Tool Touch TT  
Position Position Number Method Height  
Z 0.0000 0 Auto TT 0.0000

End of Cycle Retract Distance: 0.500

WCS #1 (G54)

Next Axis F1 Probing Cycles F5 Prev WCS F6 Next WCS F7 CSR F8 WCS Table F9 Set F10

Acorn CNC

AUX 1 AUX 2 AUX 3 AUX 4

100% 25% 50% 75%

FAULT RESET

View Crosshair Toggle F6 F7 G-Code F8 T-Shape Toggle F9 Show Tools F10

Acorn CNC

AUX 1 AUX 2 AUX 3 AUX 4

100% 25% 50% 75%

FAULT RESET

WCS #1 (G54) Current Position (Inches)

X +0.0000  
Y +0.0000  
Z +3.3979

Job: sample\_siemens\_encoder\_face.cnc  
Tool: T1 H1  
Feedrate: 100% 0.0 ipm  
Spindle: 0 A  
Rapid Rate: 100%

335 Emergency stop released  
347 Reset Cleared  
490 Reset Initiated, Press Reset to Clear  
347 Reset Cleared

Distance to Go  
X +0.0000  
Y +0.0000  
Z +0.0000

Machine (MCS)  
X +0.0000  
Y +0.0000  
Z +3.3979

Center of Bore

1. Position probe inside hole
2. Press CYCLE START to start

WCS #1 (G54)

Next Axis F1 Probing Cycles F5 Prev WCS F6 Next WCS F7 CSR F8 WCS Table F9 Set F10

Acorn CNC

AUX 1 AUX 2 AUX 3 AUX 4

100% 25% 50% 75%

FAULT RESET

WCS #1 (G54) Job: sample\_helix.cnc

X -0.2864  
Y -0.3804  
Z -1.0000

Distance to Go  
X -0.3511  
Y -0.5696  
Z +0.0000

Spindle RPM:  
S: +3000 A

Feedrate:  
100%  
0.0 ipm

36. N0008 G3 X0.0 Y-1.9 Z-1.0 J-0.95 F20... 303 Paused...

Press CYCLE CANCEL to cancel

View Crosshair Toggle F6 F7 G-Code F8 T-Shape Toggle F9 Show Tools F10

Acorn CNC

AUX 1 AUX 2 AUX 3 AUX 4

100% 25% 50% 75%

FAULT RESET

WCS #1 (G54) Current Position (Inches)

X +0.0000  
Y +0.0000  
Z +3.3979

Job: sample\_siemens\_encoder\_spacer\_face.cnc  
Tool: T1 H1  
Feedrate: 100% 0.0 ipm  
Spindle: 0 A  
Rapid Rate: 100%

335 Emergency stop released  
347 Reset Cleared  
490 Reset Initiated, Press Reset to Clear  
347 Reset Cleared

Tool Geometry Offset Library

Tool #	Reference Tool	Height Offset	Diameter
H001		0.0000	D001 0.0500
H002		0.0000	D002 0.2500
H003		0.0000	D003 0.5000
H004		0.0000	D004 0.6250
H005		0.0000	D005 0.7500
H006		0.0000	D006 0.2500
H007		0.0000	D007 0.1650
H008		0.0000	D008 0.2500
H009		0.0000	D009 2.0000
H010		0.0000	D010 0.0000
H011		0.0000	D011 0.0000
H012		0.0000	D012 0.0197

Ready to Measure Tools! (Z Ref Pos = 3.3979 MCS)

Set Z Ref F1 Manual Measure F2 Auto Measure F3

+0.1 F5 -0.1 F6 Save F10

WCS #1 (G54)

Next Axis F1 Probing Cycles F5 Prev WCS F6 Next WCS F7 CSR F8 WCS Table F9 Set F10

Acorn CNC

AUX 1 AUX 2 AUX 3 AUX 4

100% 25% 50% 75%

FAULT RESET

WCS #1 (G54) Job: PAWN-MM.cnc

X +0.0000  
Z +0.0000

Tool: T0300  
Feedrate: 100% 0.0 mm/min  
Spindle: 0 A  
Rapid Rate: 100%

Program # 20000  
Part Cnt: 0  
Part #: 0  
Time: 0:12:29

347 Reset Cleared  
313 Waiting for dwell time  
302 Moving...  
307 Operator abort: job cancelled

Set Z Part 0/Position

- 1.) Jog to Touch Off on Part
- 2.) Edit the Value if Necessary
- 3.) Press F10 to Set Position

Axis Part Tool  
Position Position Number  
Z 0.0000 0

WCS #1 (G54)

Prev WCS F6 Next WCS F7 Set X F8 WCS Table F9 Set F10

Acorn CNC

AUX 1 AUX 2 AUX 3 AUX 4

100% 25% 50% 75%

FAULT RESET

WCS #1 (G54) Current Position (Inches)

X +5.3750  
Y -6.1871  
Z +0.0000

Job: sample\_gusset.cnc  
Tool: T2 H2  
Feedrate: 100% 0.0 ipm  
Spindle: 0 A  
Rapid Rate: 100%

Program # 20000  
Part Cnt: 0  
Part #: 0  
Time: 0:00:34

302 Moving...  
303 Paused...  
302 Moving...  
302 Moving...  
307 Operator abort: job cancelled

Set Part 0/Position

- 1.) Jog to Touch Off Part
- 2.) Edit Part position value if necessary
- 3.) Enter Tool Number Being Used
- 4.) Press F10 to Set Position

Axis Part Edge Finder Approach  
Position Position Diameter From  
X 0.0000 0.0000 Right(+)

Press SPACE to change

WCS #1 (G54)

Next Axis F1 Auto Mode F4 Probing Cycles F5 Prev WCS F6 Next WCS F7 CSR F8 WCS Table F9 Set F10

Acorn CNC

AUX 1 AUX 2 AUX 3 AUX 4

100% 25% 50% 75%

FAULT RESET

Link to photo album with more v5.42 screen shots. <https://photos.app.goo.gl/di6UeLbq35Q1AYk9>

Added a TT or TP selection to Automatic Reference Position setting when using a Reference tool. Be sure to select which probe (a TT or TP) you'd like to use when setting a Reference Position using a reference tool. You can do this one of two ways 1.) Acorn/AcornSix/Hickory Wizard users can make the selection in the Tool Touch Off Configuration menu -or- using the CNC12 Parameter 43.

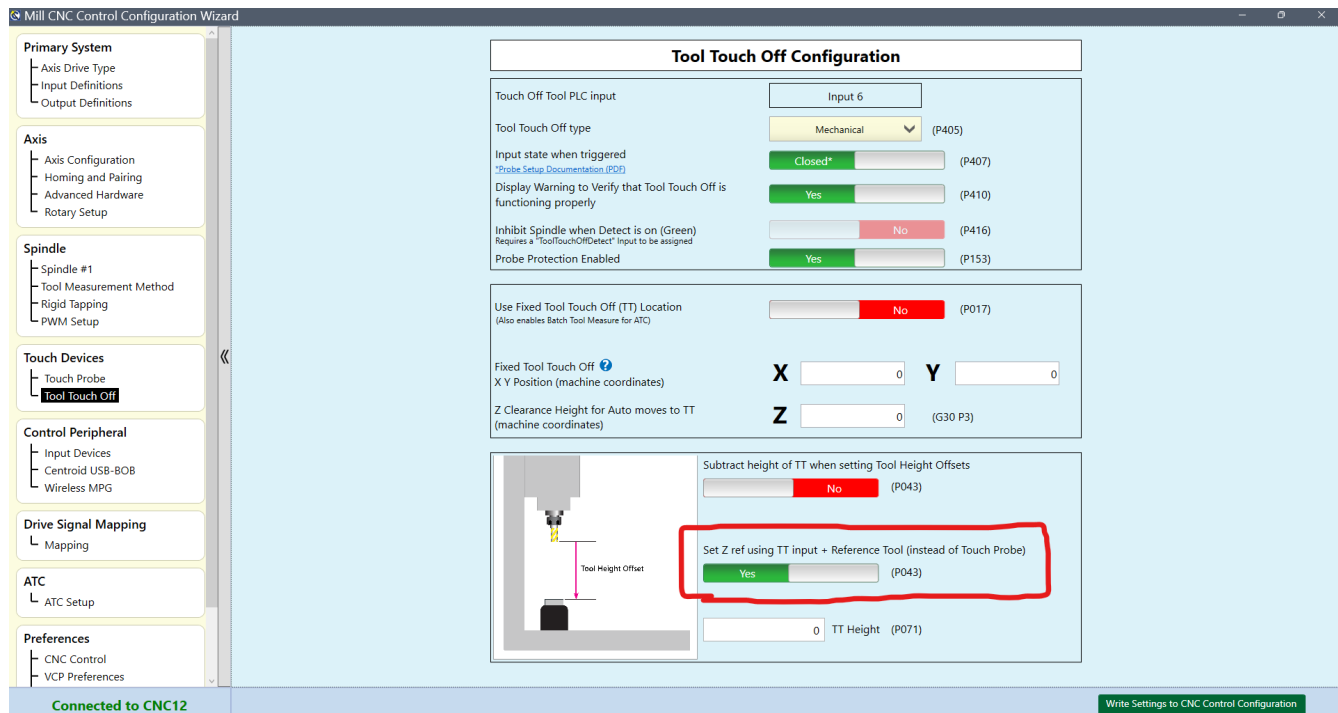

The Wizard will Add 2 to P43 value to use the TT (Tool Touch Off) to set the Z Reference Position when this slider is set to Yes.

Wizard adds nothing to P43 value to default to using the TP (Touch Probe) to set the Z reference position. In this case the Touch Probe *is* the Reference Tool!

**New/Updated CNC12 Parameters for Oak/Allin1DC/Hickory not using Wizard Touch Probe Users. When updating or doing a fresh install it is up to the integrator/installer to adjust all Probing and Tool touch Off related parameters manually when no CNC Setup Wizard is being used! For instance when updating an Oak, Allin1DC, or Hickory (no wizard) systems. Adjust these to your probing preference.**

- P43 TT for z ref vs. using TP for Z ref. add 2
- P44 is TT trigger input #
- P257 is TT Detect input #, set to 0 if no tt detect is being used
- P410 = 0 to remove optional stop warning for probe function check.

Also, check See and review all probing related Parameters 11-18 and 404-410 before using/testing any touch device.

more details for each are found in the CNC12 operator manuals.

## - Bug fixes for all

- Deprecated RunCommand(string command, string cnc12\_working\_directory, bool require\_cycle\_start = true) as working directory is no longer required. CNC12 now handles writing of temporary job files
- Fixed bug causing jerky MPG or WMPG movement and position errors at x10 and x100
- Improved Ether1616 communication error event action and reporting.
- Fixed bug where SV\_?\_AXIS\_POWERED system variables (where ? is an axis label) did not reflect the correct axis
- Fixed bug where hitting F5 and F6 simultaneously in the util menu while P4 bit 3 (add 8) was not set would result in the DRO displaying over-top of the Restore Files file selection menu
- Fixed bug where starting a job with 3D-RTG active, pressing "G-code", pressing "Graph", and pressing "Show Tools" would shrink the 3D-RTG graph and expand the F8 Graph
- Fixed bug where nose vector would follow the tool number rather than the offset number in the lathe 3D RTG
- Fixed bug where a slaved 5th axis wouldn't be assigned to the Slaved Home Input in the wizard
- Fixed bug in "Show Tools" where M107 tool prefetch would cause the tool paths to be mislabeled/misassigned on the graph, this bug only occurred with Random Access Tool Changer equipped machines.
- #401 custom error messages will now occur in graph view, if applicable
- Job.RunCommand will error out if temporary job files still exist
- Cycle start from the tool check graph menu will not be stifled by P400 is it is not set to a 1
- Fixed bug where MPG movement would exceed the boundaries defined by limit switches (this fixed bug would show itself on Hickory)
- Fixed bug where Acorn Plasma would require a license to use Software axis pairing
- Added APIBuildRevision and CNC12BuildRevision properties to the API. API and CNC12 build revisions should match while developing applications
- Fixed bug where Restore Report would incorrectly determine a report was not compatible with the current software if a report.txt from an older version of software was present in the report.zip
- Added option to keep last known reference point if reference point set status was lost due to machine unhomming
- Added API call System.CreateReport which will create a CNC12 report in a designated directory
- Keyboard Jogging Active notification moved to indicator board
- Fixed bug where tool offset would follow the tool number rather than the offset number in the lathe 3D RTG
- Removed character limit for messages in the outbound pipe of the API
- Added M2XX message reporting to the outbound pipe of the API
- Fixed a bug where oscillation of the MPG position would prevent jogging, axis switching, etc.
- Fixed bug where M291 required that MPG Offset mode be active in order for it to function properly. This also now resets the offset for all MPGs
- Fixed bug where Hyperlinks in M2XX messages would persist indefinitely

- Fixed bug where MDI would not display M2XX messages as history if a html style tag was included
- Fixed bug where setting skinning words via the API beyond W1 would fail
- Added clearance height to the Z-Axis Part Menu in Mill
- Added new Tool Check Graph Menu. Only available if using 3D-RTG which requires the v5.40 License Upgrade
- Fixed bug where a job loaded from the api would repeat forever because loadcommand.txt could not be deleted due to a file lock
- Added more color definitions for better control of GUI colors
- Fixed bug where Hickory Wizard would set all probes to NC instead of to NO
- Fixed bug where wizard would set a mechanical TT input type to be "Open" when reentering the menu
- Color Picker will now be enabled by default. Centroid 2026 will be the default color scheme
- Fixed bug where the Windows Key would not disable the exclusive focus watchdog in some menus
- Added focusWhitelist.txt which allows non-Centroid applications to be allowed to have focus while the focus watchdog is enabled. This file is read on launch of CNC12. Centroid applications are always whitelisted internally, regardless of their presence within this file.
- PLC Detective: Added search functionality to watch tab.
- Fixed bug where homing order would not be correct when using hardware paired axes after relaunching the wizard
- Fixed bug where "Install over existing" install option would not overwrite old image files in the /bmp folder
- Fixed bug where old router homing image would show up when using autosquaring
- New P322 added. A bitwise parameter that disables the absolute encoder warning that displays when an axis has moved too many counts since the last software exit.

Note that P322 is encoder based similar to P316. Taken from the P316 example:

For example, if the X-, Y-, and Z-axes had absolute encoders and Parameters 308, 309, and 310 were set to the values 7, 8, and 9, then to disable the absolute encoder warning for the X-, Y, and Z-axes this parameter would be set to 448 ( $2^6 + 2^7 + 2^8$ ).

CNC software is now available for use with Acorn, AcornSix, Hickory, Allin1DC, Oak and MPU11. Please [Follow the installation instructions](#). Do not use "restore report" using a report from an earlier version.

All previous license files file work with this new version of CNC12 software (in their respective categories: Acorn mill licenses work with Acorn mill, Oak lathe licenses work with Oak lathe CNC12, etc.) Bug fixes are free.

v5.40.01, v5.40.02 and v5.40.04, v5.40.05 "point release" release notes start on page 32

V5.4 Release Notes

- Starting with v5.40.00 Centroid has rolled out an optional software version feature upgrade charge for existing License holders. All bug fixes and some features and improvements are free. Your existing license file will work with this new version. Pay only for new features only if you want them for a modest upgrade dollar amount which will enable reinvestment in our team, ensuring the continued development of our CNC software that provides enhanced value for our customers (your controller keeps learning new tricks! ) while maintaining the strong Centroid CNC support services that come along with each new version of CNC12. Read the details and FAQ here.

[https://www.centroidcnc.com/centroid\\_diy/centroid\\_cnc\\_software\\_licensing.html](https://www.centroidcnc.com/centroid_diy/centroid_cnc_software_licensing.html)

CNC12 Options and Licensing Menu. F7 Utility → F8 CNC12 License

### CNC12 Options and Licensing Menu

Version: CNC12 Acorn Router v5.39.01 BETA  
 URL: /cnc11/trunk R21352 clean  
 Date: Aug 19 2025, 15:29:38  
 CNC System ID: 38D2694D64EF-0406180825  
 CNC12 License: v5.3 ACORN ROUTER PRO

Click or Scan to Upgrade

New capabilities introduced in CNC12 v5.4	Router Pro	Router Ultimate
Dynamic 3D/2D Run Time Tool Path Graphics (RTG)	<a href="#">Upgrade License to 5.4 -or- Ultimate</a>	<a href="#">Upgrade to Ultimate</a>
Improvements and additions to G-Code Backplot with new Display Options menu	Included	Included
Improved Software Axis Pairing w/ new easy pair/unpair mcodes M294/M295	Included	Included
Up to 8 axes can now be paired together	<a href="#">Upgrade to Ultimate</a>	<a href="#">Upgrade to Ultimate</a>
Multiple axes can be slaved to a single master and master-slave axis pairings can be chained together	<a href="#">Upgrade to Ultimate</a>	<a href="#">Upgrade to Ultimate</a>
Pairing axes 6,7,8 to any other axes in any combination	<a href="#">Upgrade to Ultimate</a>	<a href="#">Upgrade to Ultimate</a>
Negative soft travel limits allowed with ball screw compensation table data	<a href="#">Upgrade License to 5.4 -or- Ultimate</a>	<a href="#">Upgrade to Ultimate</a>
Planar Compensation, Machine Position Correction, remove machine bows/bumps/skew	<a href="#">Upgrade to Ultimate</a>	<a href="#">Upgrade to Ultimate</a>
Unique Individual Planar Compensation position correction tables for both Master and Slave paired axes	<a href="#">Upgrade to Ultimate</a>	<a href="#">Upgrade to Ultimate</a>
Spindle RPM Scaling. For Hi-RPM spindles which dont operate below a significant RPM	<a href="#">Upgrade License to 5.4 -or- Ultimate</a>	<a href="#">Upgrade to Ultimate</a>
Don't use Machine Home and still remember WCS position after a power cycle	Included	Included
Improved CNC Setup Wizard Speed! Big reduction in CNC control parameter writing time	Included	Included
Control the number of Rows and Columns that make up the Virtual Control Panel (VCP).	Included	Included
Wizard Drag-and-Drop Canned Moveable ATC Rack Control Support	<a href="#">Upgrade License to 5.4 -or- Ultimate</a>	<a href="#">Upgrade to Ultimate</a>
Wireless Touch Probe Feature Support such as Awake and Ready signaling	<a href="#">Upgrade to Ultimate</a>	<a href="#">Upgrade to Ultimate</a>
MPG/Scale/Encoder real time position offset adjustment for any axis with M291 offset cancel or keep	<a href="#">Upgrade to Ultimate</a>	<a href="#">Upgrade to Ultimate</a>
Automatic Adaptive Feedrate Modulation based on Spindle RPM	<a href="#">Upgrade to Ultimate</a>	<a href="#">Upgrade to Ultimate</a>

**100%**

**+**

**100%**

**+**

**+**

**SET WCS XY0**

**SET WCS Z0**

**Auto Z to PLATE**

**PARK**

**SET ROTARY WCS**

**M55**

**M58**

**LASER SET XY**

**LASER ON/OFF**

**RESET HOME**

**AUTO SPINDLE MAN**

**M3**

**M4**

**AUTO MAN**

**DUST Collector**

**Hold Down VAC**

**Air Blow**

**Change TOOL**

**INCR CONT**

**x1**

**x10**

**x100**

**MPG**

**4th+**

**Y+**

**Z+**

**4th-**

**Y-**

**Z-**

**SINGLE BLOCK**

**TOOL CHECK**

**FEED HOLD**

**RAPID FEED**

**FEED Override 100%**

**RESET**

**PRESS TO RESET**

**OK**

**25%**

**50%**

**75%**

**UTILS**

**VCP OPTIONS**

**FREE**

**Esc**

Import License

F8

Enlarge QR Code

F10

If the CNC control has an internet connection you can click on any link to purchase a version upgrade or a new License level, Pro/Ultimate/Ultimate + . , if no internet connection at the CNCPC then use your phone to scan the QR code.

The Centroid License web page purchase portal will present you with all available options for your system. Both the link and the QR code contain the version and current license information of the system and the new web page will automatically recognize it and present you with the system and license information and all available upgrade options.

### Current System Information

Current CNC12 Software Version: **Acorn CNC12 v5.3 Router**  
 Current CNC12 License Level and Version: **Acorn CNC12 Router Pro v5.3**  
 Acorn Serial Number: **38D2694D64EF-0406180825**  
 Acorn Nickname:

### Available CNC Software Upgrades

Acorn - Upgrade to 5.4 Pro	\$79.00	<b>ADD TO CART</b>
— OR —		
Centroid CNC12 Router 5.4 Software License for Acorn <b>Upgrade from Router "Pro" to Router "Ultimate"</b>	\$225.00	<b>ADD TO CART</b>

[Need a license for a different board? Click here to upload a Report.zip](#)  
[View your Centroid Controllers](#)

### Feature Table

New capabilities introduced in CNC12 v5.4	Router Pro	Router Ultimate
Dynamic 3D/2D Run Time Tool Path Graphics (RTG)	Upgrade to v5.4 <b>OR</b> Upgrade to Ultimate	Upgrade to v5.4 <b>OR</b> Upgrade to Ultimate Plus

2. Mill, Lathe and Router. New real time Tool Path Backplotting Graphics while running a job. ("RTG" Run Time Graphics = Live Tool Position with G code program backplot. Dynamic 3D rotation/views (mill and router) with user control over display of additional information such as WCS position, Current tool position, Work envelope, Software Travel limits, Material Size, Tool indicator actual diameter while running a part program live, a solid plane with opacity option for the work envelope, toggled through the show tools menu. A v5.4 Pro or Ultimate License is required for this feature.

WCS #1 (G54) Job Name: sample\_gusset.cnc

X +2.2010  
Y -1.7492  
Z -0.2500

Distance to Go  
X +3.0877  
Y -3.2228  
Z +0.0000

Spindle RPM:  
S: +12000 A

Feedrate:  
100%  
0.0 ipm

Material Size

Tool 094  
Rapid  
Origin  
Travel  
Material Size

Tool  
Tool Path  
Part

37. N0008 G3 X5.1444 Y-5.1761 Z-0.25 I11... 303 Paused...

Press CYCLE CANCEL to cancel

View F6	Crosshair Toggle F7	G-Code F8	T-Shape Toggle F9	Hide Tools F10
------------	---------------------------	--------------	-------------------------	----------------------

Acorn CNC

AUTO SPINDLE MAN  
100%  
M3  
M4  
SET WCS XY0  
SET WCS Z0  
Auto Z to PLATE  
PARK  
SET Rotary WCS  
M55  
GOTO WCS XY0  
LIMIT SWITCH DEFEAT  
M58  
LASER SET XY  
LASER ON/OFF  
RESET HOME  
DUST Collector  
Hold Down VAC  
Air Blow  
Change TOOL  
INCR CONT  
x1  
x10  
x100  
MPG  
4th+  
Y+  
Z+  
X-  
X+  
4th-  
Y-  
Z-  
SINGLE BLOCK  
TOOL CHECK  
FEED HOLD  
RAPID FEED  
FEED Override 100%  
100%  
25% 50% 75%  
RESET  
PRESS TO RESET  
OK  
UTILS  
VCP OPTIONS  
FREE

See Uwe Mattern's Video for live demonstration of the new run time graphics.

[https://youtu.be/LPvx8mNNLC4?si=TLs2vAeQ\\_J8yehgj](https://youtu.be/LPvx8mNNLC4?si=TLs2vAeQ_J8yehgj)

WCS #1 (G54) Job Name: ScaleRing.nc

X -7.583  
Y +0.001  
Z +12.396  
A +122.387  
C +6.571  
B +1.680

Distance to Go  
X -3.317  
Y -0.001  
Z +0.004  
A +0.006  
C -0.001  
B +0.000

Spindle RPM:  
Act.: +509 A  
S: +500 A

Feedrate: 261. N1295 G94 X-10.9 F900. 302 Moving...

100%  
22 mm/min

Press CYCLE CANCEL to cancel  
1:24 / 13:09

View F6  
Crosshair Toggle F7  
G-Code F8  
T-Shape Toggle F9  
Show Tools F10

Control Panel:  
+ AUTO SPINDLE MAN SET ALL 0  
100% M3 SET AXIS 0 Calculate Vf from fz  
- M4 Calculate Vfc  
FEED Calculate rpm  
RESET HOME  
AUTO MAN FLOOD M8 MIST M7 VAC ON M27  
CHIPS INCR CONT x1 x10 x100  
C+ A+ Y+ Z+  
B+ B- X- X+  
C- A- Y- Z-  
SINGLE BLOCK TOOL CHECK FEED HOLD  
LASER SET XY Laser Check X0Y0  
RAPID FEED RAPID Override 100%  
RESET  
25% 100% 75%  
UTILS VCP OPTIONS FREE

WCS #1 (G54) Job Name: sample\_gusset\_array.cnc

Machine Software Trave Limit

Tool 094  
Rapid  
Origin  
Travel  
Material Size

Material Size

Tool

Distance to Go  
X -0.0000  
Y +0.0000  
Z +4.5868

Spindle RPM:  
S: 0 A

Feedrate:  
100%  
0.0 ipm

27. N0005 T94 M6 Tool change: T94

Insert tool and press CYCLE START

View F6	Crosshair Toggle F7	G-Code F8	T-Shape Toggle F9	Hide Tools F10
------------	------------------------	--------------	----------------------	-------------------

Acorn CNC

100% M3 M4

SET WCS XY0 SET WCS Z0 Auto Z to PLATE PARK

SET Rotary WCS M55 GOTO WCS XY0 LIMIT SWITCH DEFEAT

M58 LASER SET XY LASER ON/OFF RESET HOME

AUTO MAN DUST Collector Hold Down VAC Air Blow

Change TOOL INCR CONT x1 x10 x100 MPG

4th+ Y+ Z+

X- X+

4th- Y- Z-

SINGLE BLOCK TOOL CHECK FEED HOLD

RAPID FEED FEED Override 100%

RESET PRESS TO RESET

25% 100% 75%

UTILS VCP OPTIONS FREE

25" x 50" Machine Total Travel example.

View: TOP T=00:09:09

Machine Software Trave Limit

Tool 094  
Rapid  
Origin  
Spindle C/L  
Travel  
Material Size

Material Size

Tool

(G54)

40  
30  
20  
10  
0  
-10

-20 -10 0 10 20 30 40 X

Pan/Rotate Esc F1	View F2	Set Range F3	Dimension Menu F4	Redraw F5	Options & Help F6	Zoom In F7	Zoom Out F8	Zoom All F9	Hide Tools F10
----------------------	------------	-----------------	----------------------	--------------	----------------------	---------------	----------------	----------------	-------------------

Acorn CNC

100% M3 M4

SET WCS XY0 SET WCS Z0 Auto Z to PLATE PARK

SET Rotary WCS M55 GOTO WCS XY0 LIMIT SWITCH DEFEAT

M58 LASER SET XY LASER ON/OFF RESET HOME

AUTO MAN DUST Collector Hold Down VAC Air Blow

Change TOOL INCR CONT x1 x10 x100 MPG

4th+ Y+ Z+

X- X+

4th- Y- Z-

SINGLE BLOCK TOOL CHECK FEED HOLD

RAPID FEED FEED Override 100%

RESET PRESS TO RESET

25% 100% 75%

UTILS VCP OPTIONS FREE

WCS #1 (G54) Job Name: Honey Wand\_10 Inches Roughing-mod.CNC

X +1.7894  
Y +0.0000  
Z +0.4490  
A +48.5400

Distance to Go  
X +0.0353  
Y -0.0000  
Z -0.0272  
A -0.0007

Spindle RPM:  
S: +15000 A

Feedrate:  
100%  
0.0 ipm

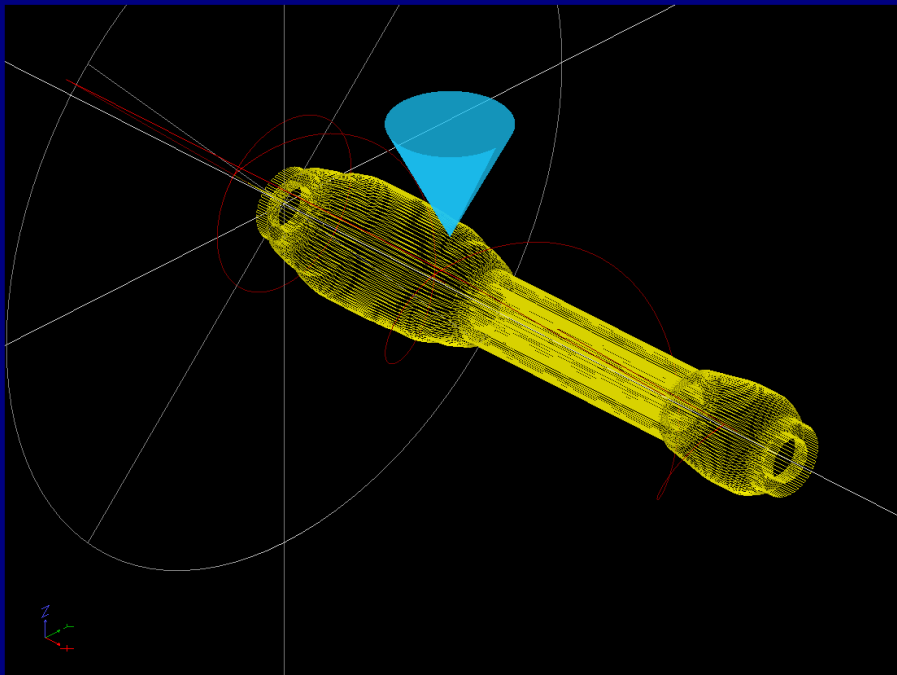

752. N7500 G01 X2.2808 Z0.5273 A48.5393

303 Paused...

Press CYCLE CANCEL to cancel

View F6	Crosshair Toggle F7	G-Code F8	T-Shape Toggle F9	Show Tools F10
------------	---------------------------	--------------	-------------------------	----------------------

**Acorn CNC**

+ AUTO SPINDLE MAN  
 100% M3  
 - M4  
 [Stop] [Start] M58  
 [Home] [Laser On/Off] [Laser Set XY]

SET WCS XY0 SET WCS Z0 Auto Z to PLATE PARK  
 SET Rotary WCS M55 GOTO WCS XY0 LIMIT SWITCH DEFEAT  
 AUTO MAN DUST Collector Hold Down VAC Air Blow [Air]

Change TOOL INCR CONT x1 x10 x100 MPG  
 A+ Y+ Z+  
 X- X+  
 A- Y- Z-  
 [Home] SINGLE BLOCK TOOL CHECK FEED HOLD [Feed Hold]

RAPID FEED FEED Override 100%  
 - 100% +  
 25% 50% 75%

**RESET**  
 PRESS TO RESET  
 OK  
 UTILS VCP OPTIONS FREE

Material Size: **Light Grey Dashed line.** -----

Can now be displayed via G code! Add the desired material size to your g code program here is the format.

:::: X- = -.125, X+ = 6

:::: Y- = -7, Y+ = .25

:::: Z- = -.75, Z+ = 0.0

Example graphics using the Material Size data above.

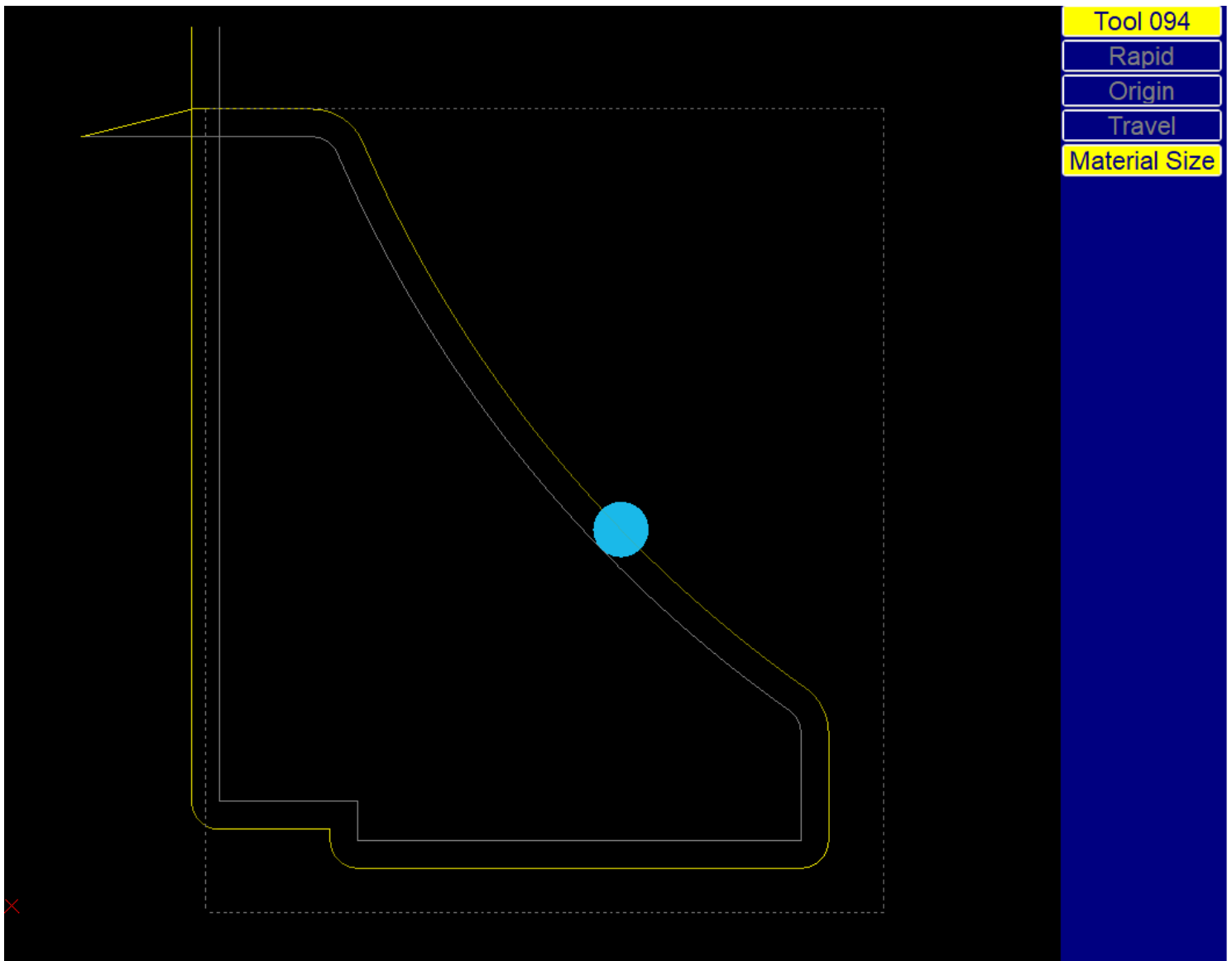

For Vectric Users Scott shows us how to setup the Vectric post processor.

```
" ; Material Size: X [XLENGTH][34] Y [YLENGTH][34] Z [ZLENGTH][34]"
" ; X_Y origin: [XY_ORIGIN]"
" ; Origin offset: [X_ORIGIN_POS] [Y_ORIGIN_POS]"
" ; Z zero location: [Z_ORIGIN]"
""
" ; Material Size Min/Max for CNC12 V5.40+ Graphing and Run Time
Graphics"
""
"      :::: X- = [XMIN], X+ = [XMAX]"
"      :::: Y- = [YMIN], Y+ = [YMAX]"
"      :::: Z- = [ZMIN], Z+ = [ZMAX]"
```

and below is an example of the Vectric generated G code using the material size post additon above.

```
; Material Size: X 12.000" Y 12.000" Z 0.750"
; X_Y origin: Bottom Left Corner
; Origin offset: 0.000 0.000
; Z zero location: Material Surface

; Material Size Min/Max for CNC12 V5.40+ Graphing and Run Time
Graphics

:::: X- = 0.000, X+ = 12.000
:::: Y- = 0.000, Y+ = 12.000
:::: Z- = -0.750, Z+ = 0.000
```

For Fusion users Uwe has already updated the Fusion 360 post to include this new feature so G code program generated by Fusion will automatically carry this data along. See this post for more information. <https://centroidcncforum.com/viewtopic.php?p=103245#p103245>

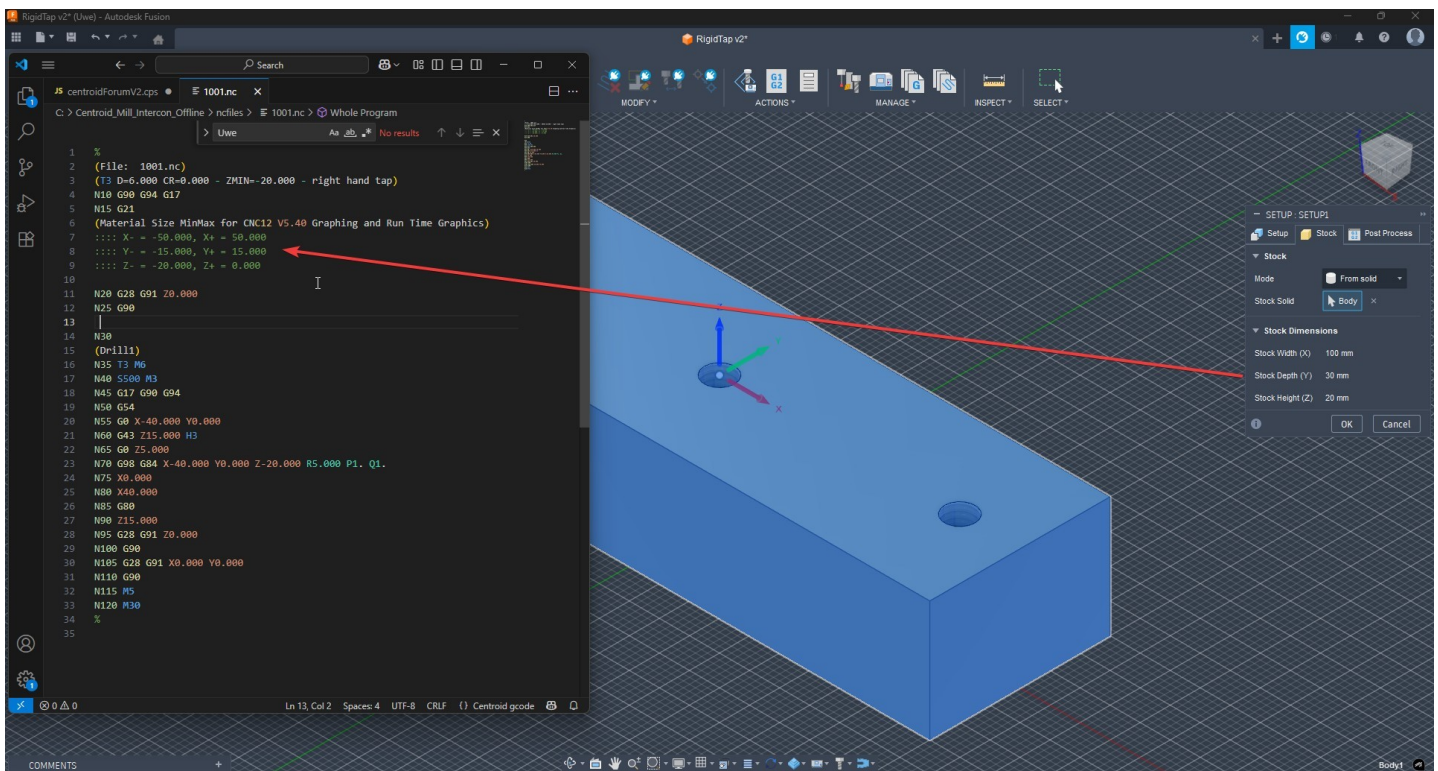

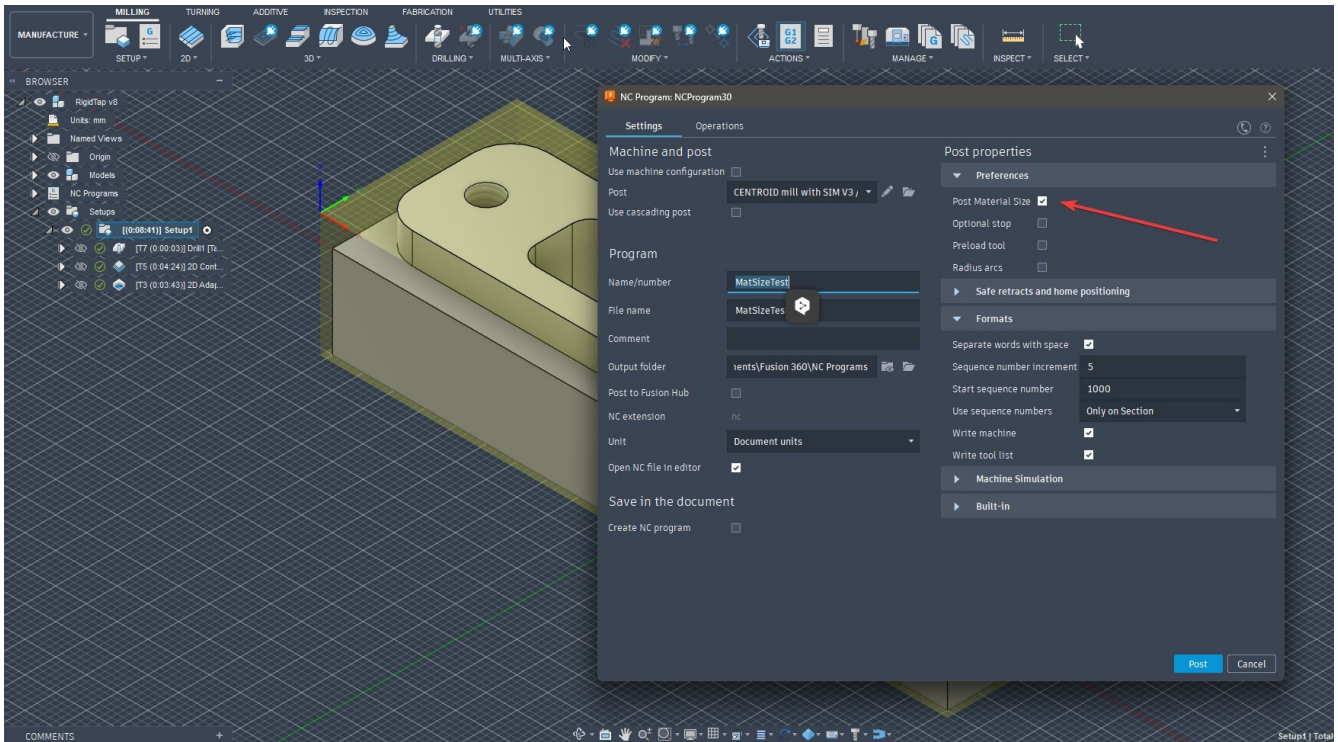
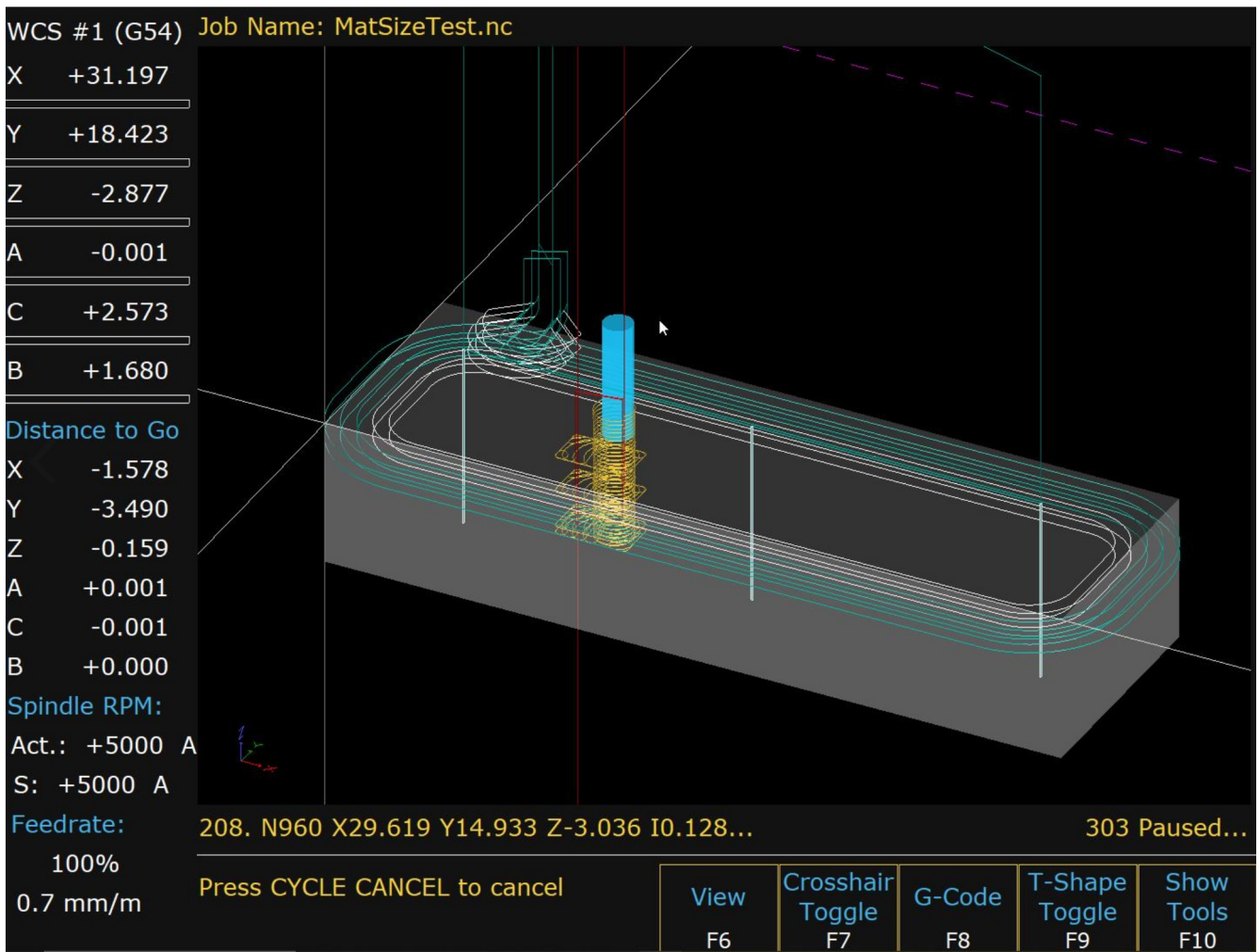

WCS #1 (G54) Job Name: sample\_gusset.cnc

X +3.6248

Y -3.5442

Z -0.4500

Distance to Go

X +1.6640

Y -1.4278

Z -0.0000

Spindle RPM:

S: +12000 A

Feedrate:

100%

0.0 ipm

Tool 094

Rapid

Origin

Travel

Material Size

65. G3 X5.1444 Y-5.1761 Z-0.45 I11.010... 303 Paused...

Press CYCLE CANCEL to cancel

View	Crosshair Toggle	G-Code	T-Shape Toggle	Hide Tools
F6	F7	F8	F9	F10

Software Travel Limits in the Wizard Axis configuration Menu.

milliseconds	Z	X	Y
Travel Limit (+)	24	24	0
Travel Limit (-)	0	0	-6

3. Added a CNC12 menu for g code graphing options. Requires a v5.4 Pro or Ultimate license.

**G-code Graphics Display Options**

Basic Options		Advanced Options	
3D Run Time G code Graphics	<span style="background-color: #008000; color: white;">On</span>	Display Enc. Indicated Spindle RPM	Actual
G-code Graphic Visualization Tools	<span style="background-color: #008000; color: white;">On</span>	Display Coordinate System Rotation	<span style="background-color: #008000; color: white;">On</span>
Material Size Color Fill Opacity (%)	0	Display A and B axis Rotation	<span style="background-color: #008000; color: white;">On</span>
Software Travel Limits Color Fill Opacity (%)	0	Display XY Skew Correction	<span style="background-color: #FF0000; color: white;">Off</span>
Work Envelope Color Fill Opacity (%)	0	Display Lash Compensation Moves	<span style="background-color: #FF0000; color: white;">Off</span>
Use Tool Lib. Diameter & Auto Scale Marker	<span style="background-color: #008000; color: white;">On</span>	G-code Smoothing Actual Tool Path	<span style="background-color: #FF0000; color: white;">Off</span>
Tool Marker Color Fill Opacity (%)	75		
Tool Marker Height Proportion	25.400		

⏏ Esc      Reset to Defaults  
F2      Help  
F3      Save  
F10

4. **Available as a BETA within v5.4.** Contact [joey@centroidcnc.com](mailto:joey@centroidcnc.com) 570-927-2516 for more information about Centroid's Fiber Laser CNC controller. CNC12 variant for Fiber Laser CNC Controller. (AcornSix hardware only for this release!). Fiber Laser feature set: Auto Focusing, Non contact Z position touch off, High speed closed loop capacitive Laser Head Z Height control, Restart Mode, start anywhere, restart anywhere, auto lead in creation ,backup along cut path, jog forward or backward along cut path, jog off cut path and start with auto lead in, Run with either the built in Material Profile manager or G-code material parameter methods both are supported, Programmable Laser Power and Frequency Level control, Gas control, note: manual focus head and contact touch off also supported. Note: Fiber Laser CNC12 be used with or without the Centroid THC.

WCS #1 (G54) Current Position (Inches)

X  
Y  
Z

Job Name: Bear23x23.tap  
Profile: SS-3mm.cnc  
Feedrate: 100% 0 ipm  
Laser Power: 0 M  
Rapid Rate: 100%

335 Emergency stop released  
347 Reset Cleared  
490 Reset Initiated, Press Reset to Clear  
347 Reset Cleared

Press CYCLE START to start job

--- Warning: Machine Home Position Not Set ---

1) Jog all axes to Machine Home Position  
2) Press CYCLE START to set the home position

**DANGER LASER OPERATING**

Machine Coord.  
X +0.000  
Y +0.000  
Z +0.000

MPU12 SYSTEM ID  
0008DC111213-0831220054  
CNC12 Laser v5.39.05 BETA  
ACORNSIX LASER FREE

Set Part Zeros F1 | Load Job F2 | MDI F3 | Edit G-code F6 | Utility Menu F7 | G-code Smoothing F9 | Shut Down Menu F10

Laser Material Profile Manager

File THC Config Setup Help

Material Profile: SS-3mm

Search: SS-3mm

Feed Rate 100 (inch/min)  
Pierce Delay 0.06 seconds  
Pierce Height 0.1 inches  
Pierce Power 1000  
Pierce Focus 0 inches  
Pierce Frequency 5000 hz  
Safe Height 2 inches  
THC Mode  Disabled  Automatic  
Gas Selection  Air  N2  O2  
Cut Height 0.025 inches  
Cut Power 1000

Save As Delete Save Done

Laser Material Profile Manager

File THC Config Setup Help

Material Profile: SS-3mm

Search: SS-3mm

Pierce Frequency 5000 hz  
Safe Height 2 inches  
THC Mode  Disabled  Automatic  
Gas Selection  Air  N2  O2  
Cut Height 0.025 inches  
Cut Power 1000  
Cut Focus -2.75 inches  
Cut Frequency 5000 hz  
Smoothing Yes  
Do Touch Off No  
Skip Pierce Height Yes

Save As Delete Save Done

5. The CNC12 software version number now is in line with industry standards and has additional decimal place. v5.40.00

v 5. 40. 00 = Major. Minor. Patch

so in the future you will start to see cnc12 versions like v5.40.01 or v5.40.03 both of these would be a revision patches of 5.40 typically would be just bug fixes.

All future version contain all features and fixes of past versions.

After v5.40.00 will be v5.50.00 and then v5.60.00. While these are considered a 'minor' new version within the major v5. They will have significant features added to them.

Note: if you see an odd number that indicates BETA software. For instance, the public beta of (yet to be released v5.40.00) for Beta testing version numbers would look like this v5.39.02 or v5.39.04 etc.

6. Each CNC12 variant now installs in it own dedicated directory. Mill =c:\cncm, Lathe = c:\cnct, Router = c:\cncr, Plasma = c:\cncp, Fiber Laser = [c:\cncf](#)

7. The CNC12 Installer now gives Hickory users two choices on how to install and configure a Hickory based CNC control system.

a.) Hickory not using the Wizard (only recommended for OEM/Advanced retrofitters)

-or-

b.) Hickory using the Centroid setup Wizard. Recommended Method (even if you are going to customize)

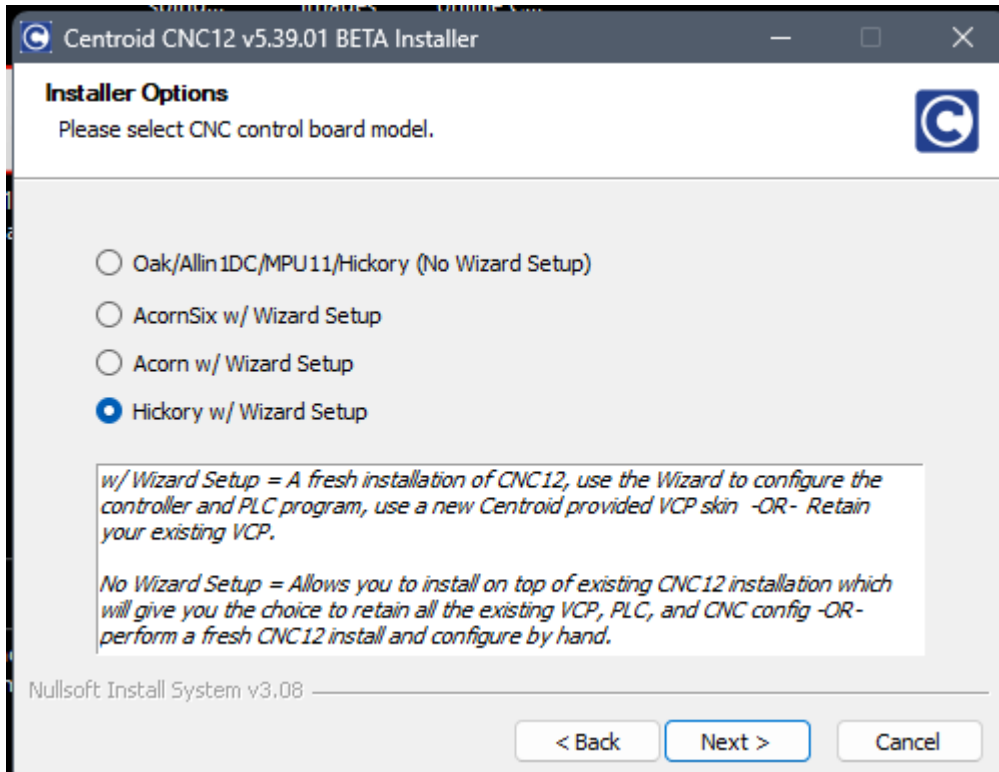

Choose Hickory w/Wizard Setup if this is your first time installing CNC12 on this CNC PC. Even if you no you are going to customize the CNC12 installation, we recommend initial setup using the Wizard as it sets a wide variety of parameters and files based on your selections and input in the Wizard for proper machine function. You can then always go modify any parameters, macros, plc programs if needed to customize the installation.

Choose Hickory (No Wizard Setup) if you want to manually setup the CNC control configuration, use a stock Centroid provided base PLC program -or- use you own customized PLC program. This selection can be used for both a fresh new installation -OR- most commonly used to “install on top” of an existing older CNC12 version (do this if you have a configured running Hickory based machine and you just want to update CNC12 and leave everything else alone).

8. Support for LS Electric Ethercat Servo drives (sold by Automationdirect.com) added for use with Hickory.

[https://www.automationdirect.com/selectors/ls-servo?\\_gl=1\\*1i1q5yh\\*\\_up\\*MQ..\\*\\_gs\\*MQ..&qclid=CjwKCAjw\\_fnFBhB0EiwAH\\_MfZn2bYJnX6YW80nwB6tu2ckjk\\_Z9yZj9WDM5ozKDP\\_nbJ-Ya1Db4ubOxoC1qsQAvD\\_BwE&gbraid=0AAAAAD\\_dnO1admGr6xSkYwMpMq3O5IT7t](https://www.automationdirect.com/selectors/ls-servo?_gl=1*1i1q5yh*_up*MQ..*_gs*MQ..&qclid=CjwKCAjw_fnFBhB0EiwAH_MfZn2bYJnX6YW80nwB6tu2ckjk_Z9yZj9WDM5ozKDP_nbJ-Ya1Db4ubOxoC1qsQAvD_BwE&gbraid=0AAAAAD_dnO1admGr6xSkYwMpMq3O5IT7t)



Reset Filters

### LS Electric Servo System Selector

**Units**

Imperial

Metric



Select Torque Required from Motor (N-m) : ⓘ

0 35.8

Rated Torque

Max Torque

9. Improved Software Axis Pairing. New software axis pairing. M294 and M295. Requires Pro or Ultimate License, while not necessary we strongly suggest purchases the v5.4 upgrade when using software axis pairing on a machine tool.

Axis Pairing Parameters:

- Slave Axis definition parameters are: P551-558 (replacing the old P64 method, P64 is no longer used)

551 = axis 1, 552 = axis 2, 553 = axis 3, etc.

Assign a slave axis to a master

Examples:

Setting P554 = 2 will slave the 4th Axis to the 2nd Axis.

Setting P551 = 2 will slave the 1<sup>st</sup> axis to the 2<sup>nd</sup> axis

Setting P552 = 4 will slave the 2<sup>nd</sup> axis to the 4<sup>th</sup> axis

- P559 controls whether the slaved axis is position is visible on the DRO while paired, useful for troubleshooting. This will display the slave axis label as "N" on the DRO.

Example for Acorn users set P559 = 8 to display the 4<sup>th</sup> axis which is used as a software slave.

Display DRO for slave axis 1 Add 1

Display DRO for axis 2 Add 2

Display axis 3 Add 4

Display axis 4 Add 8

Display axis 5 Add 16

Display axis 6 Add 32

Display axis 7 Add 64

Display axis 8 Add 128

If you have more than one sets of paired axes you can display all the slave axes by adding up the numbers. For example

- P579 is the minimum AUTO paired axis resync tolerance, this is the max deviation the axis can automatically re-square the axis after an Estop release without a pop-up message to the operator asking to press cycle start to resync. Typically this number is adjusted for the type of machine, machines with lots of spring in the paired axis can use a larger number so the controller just automatically resyncs the paired axes after an estop event and is ready to run. Some other types of machine may want to use a small number so any unexpected (by the operator) motion to resync is minimized. Operator is presented with a message to press cycle start to move to resync when the two motors are out of position by more than the tolerance specified. For Example on a typical CNC Router Gantry. When P579 = .050", after an Estop release CNC12 looks at the two encoders on the master and slave motors and determines if the two sides of the gantry are within .050" if yes then the machine will automatically move the master and slave back to the SYNC position at the slow jog rate upon an Estop release.

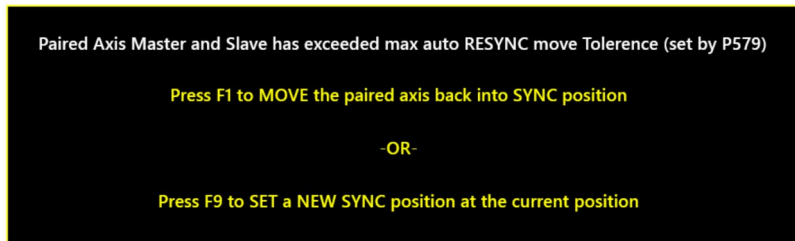

If the controller determines the gantry axis is out of sync by more than .050" the operator is prompted with a message letting him know that the gantry is out of square by more than the P579 value and to press cycle start

- M-Codes: Two new M-Codes are introduced to eliminate the need to modify the parameters directly to pair and unpair servo motor drives.

**M294** Unpair and **M295** Re-Pair and Sync, and **M295 with P1** Move to Sync position and Re-Pair.

Examples:

M294 / \* (Where \* is the master axis Label) will un-pair the paired axes.

This will allow the two axis motors to be commanded separately if desired. Useful in auto squaring macros.

Y axis Examples:

**M294 / Y** will UnPair what ever axis has been paired with the Y axis.

**M295 / Y** will Re-Pair and **RESETS** the SYNC position at the current location between the two axes.

**M295 / Y P1** will **MOVE** the Slave motor back independently to the last known SYNC position previously set between the two axes and then Re-Pair the two motors.

**M295 / \* P2** - Tells CNC12 to ignore re-sync, and does not update the sync position. This is for cases where the user only wants to re-pair the axes in their current location without re-syncing or setting a new sync position.

#### **New M26 and M26/Q1 functionality:**

M26 /\* - Homes the master axis and any axes slaved to that master, but does not pair the axes. This will also set the sync position between all homed pairs.

M26 /\* Q1 - Re-syncs the slaved axes, homes the master axis and any slaved axes, and sets the sync position between all homed pairs. This does not pair the axes.

Other notable action when compared to previous versions. With Hickory Ethercat controller an E-Stop and a Powercycle is no longer required to set the Square and Paired Axis and Home Positions.

10. Up to 8 axes can now be paired together using new parameters P551-558. [Requires a v5.4 Ultimate License.](#)
11. Multiple axes can now also be slaved to a single master and master-slave axis pairings and can now be chained together. [Requires a v5.4 Ultimate License.](#)
12. Pairing axes 6,7,8 to any other axes in any combination. [Requires a v5.4 Ultimate License.](#)

Negative travel limits with screw compensation are now allowed when using ballscrew pitch compensation ([requires a v5.4 Pro or Ultimate License](#))

13. Planar Compensation. (formerly known as 2.5D VC) This is Machine Position correction compensation tables that use information from 2 axes. With this feature you can take a bow, bump, angle or skew out of an a set of axes. Very useful for CNC router XY and Bed Mill XZ or YZ or Lathe XZ machine position correction, this feature allows you to correct for mechanical position issues with the machine tool. [Requires a v5.4 Ultimate License](#) See this post for instructions with video demonstration. <https://centroidcncforum.com/viewtopic.php?t=9266>
14. Unique Planar Compensation correction tables for Master and Slave paired axes. [Requires a v5.4 Ultimate License.](#) CNC12 can now use two different position correction data tables, one for each of the paired axis motors. For example, A two axis motors paired on a moving gantry: Y1 and Y2, previously used the Y1 correction table for both Y1 and Y2 movements, Now Y1 and Y2 can have their own

dedicated correction lookup tables to correct for pitch errors (screw compensation) between the master and slave while also correcting for bows/bumps/skew (planar compensation) in the machine tool.

15. Spindle RPM Scaling. Useful for hi RPM spindle machines like CNC Routers that don't operate below a significant RPM. Available across all platform and included in the Hickory, Acorn, AcornSix Wizard and stock PLC programs. Feature **requires a v5.4x.x Pro or Ultimate License**.

A new slider in the Wizard spindle menu enables the feature.

When slider is set to No, the 0-10V output voltage is scaled normally from 0 to max spindle speed.

When slider is Yes, the 0-10V output voltage is scaled from minimum to max spindle speed.

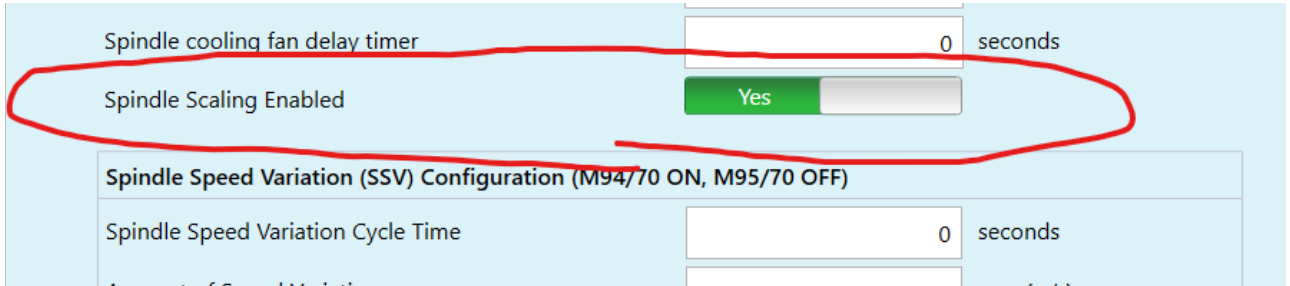

So for Example,  
when Max Spindle Speed = 24000  
and Min Spindle Speed = 6000

Without Scaling,  
S0 = 0V  
S6000 = 2.5V  
S12000 = 5V  
S18000 = 7.5V  
S24000 = 10V

With Scaling  
S0 = 0V  
S6000 = 0V  
S10500 = 2.5V  
S15000 = 5V  
S19500 = 7.5V  
S24000 = 10V

For non Wizard users this feature is with Parameter 78 Bit 4 (add 16) and the supporting PLC program logic is included with all the Centroid provided programs across all platform (Oak, Allin1DC, Hickory, Acorn, AcornSix)

16. Wizard Drag and Drop Canned Moveable ATC Rack Support. New Inputs added to the ATC section of the Wizard. "ToolRack In Sensor" and "ToolRack Out Sensor" requires a v5.4x.x Pro or Ultimate License

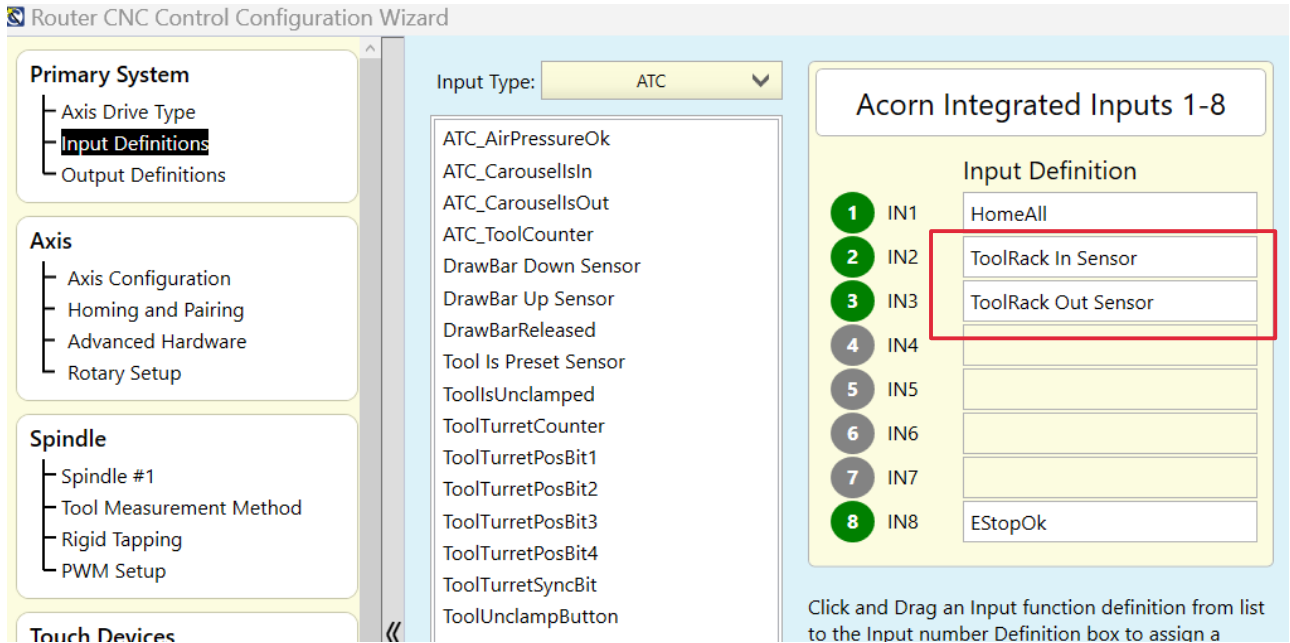

Works automatically with your Rack Mount Setup page.

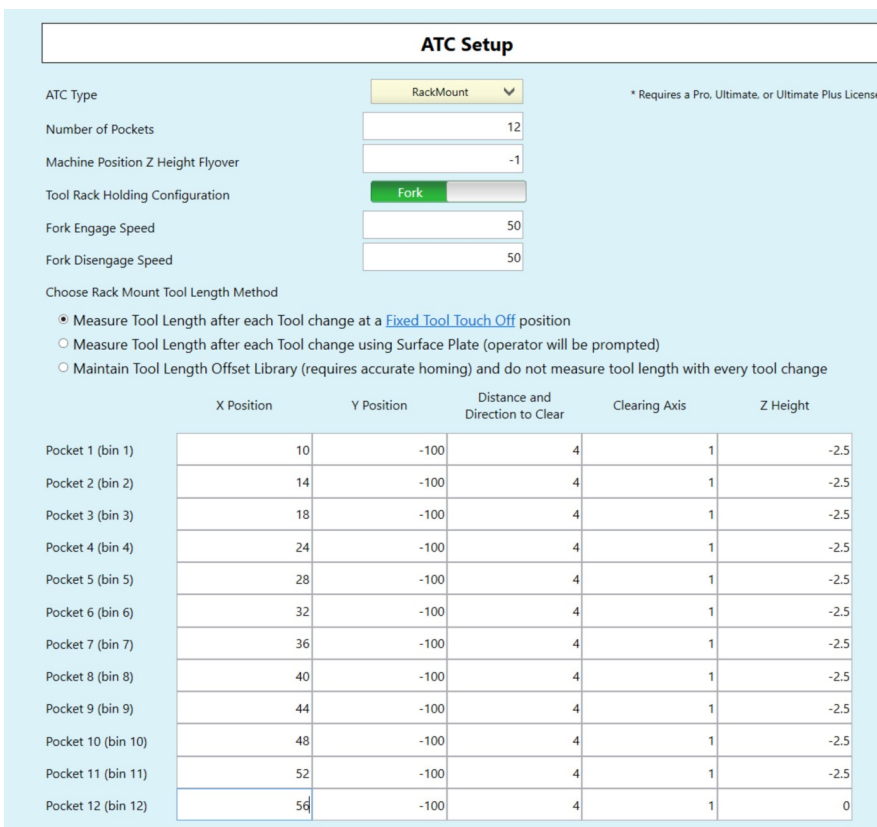

Note: The Wizard automatically programs the PLC program with this logic:

Tool Rack In (Towards Spindle) = SV\_M94\_M95\_80

Tool Rack Out (Away from Spindle) = SV\_M94\_M95\_81

Logic is under the "ToolRackInOutStage" in PLC.

Wizard also sets Parameter 830 to 7. to let the PLC program know that the ATC type is Rack Mount.

17. A new “Don't use Machine Home” selection will remember WCS position after a power cycle/ Remember part zero after power cycle without homing the machine. The Wizard feature: “Don't use Machine Home” will now remember last known WCS position and reinstate that DRO position after a power cycle. This feature is for Open/Hybrid loop systems that don't want to use home to switch and want to mimic absolute encoder functionality. While not for everyone, this feature works well for some applications as long as the machine does not move while being powered down. [requires a v5.4x.x Pro or Ultimate License](#)
18. Significant Wizard speed increase reduces the time that it takes the Wizard to write CNC12 files and parameters. Its fast.
19. Improved Plasma Backup Torch along path responsiveness, quicker and more natural. Better UX in the popular Plasma restart mode feature.

20. Control the number of Rows and Columns that make up the Virtual Control Panel (VCP)

VCP: Two new tags have been added

<column\_count> </column\_count>

and

<row\_count> </row\_count>

These tags are use to define the number of rows and columns that the VCP uses.

Place the tags right under the <vcp\_skin> tag.

For example lets add a row and a column to the VCP base layout.

To increase the number of columns from 6 to 7 and the number of rows from 14 to 15, add the following lines to the skin xml file. This additional area can be use just like any other row and column on the VCP. More info and other examples can be found in the [VCP Users manual](#).

<vcp\_skin>

<column\_count>7</column\_count>

<row\_count>15</row\_count>

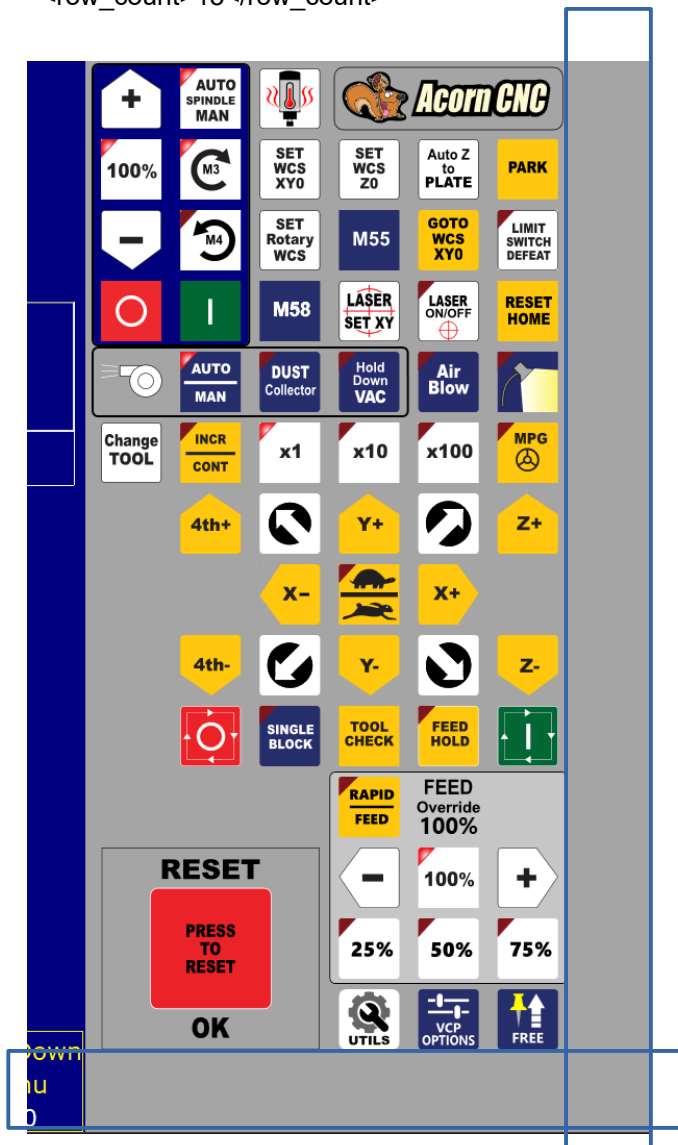

21. Lathe: G codes for XY ,and YZ arcs have been added to CNC12 Lathe, G17 and G19. [requires a v5.4 Pro or Ultimate License](#)

See Uwe Mattern's Video [https://youtu.be/X76VosJb924?si=QaETShqcCGB\\_sqz](https://youtu.be/X76VosJb924?si=QaETShqcCGB_sqz)

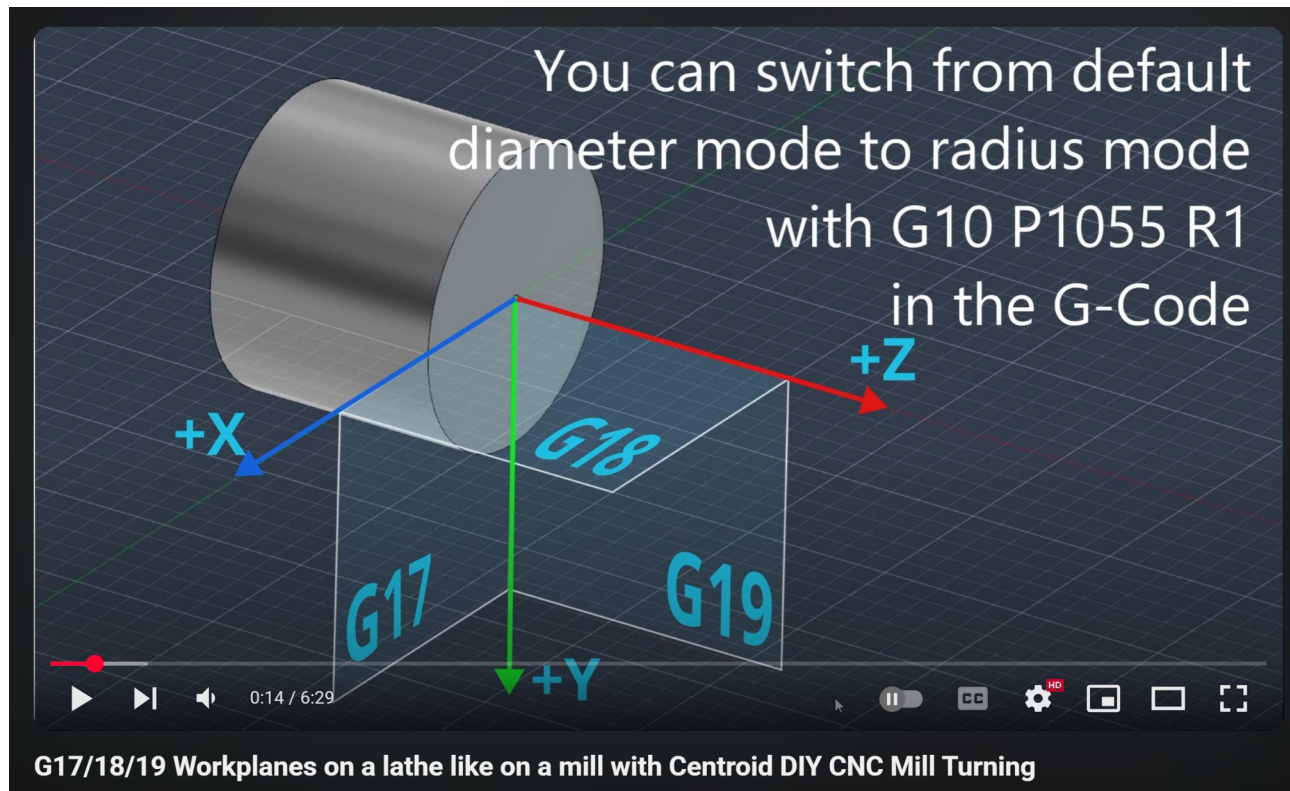

22. CNC12 Lathe Graphics has been upgraded and now use the same v5.4 g code backplot graphics engine as the other v5.4 variants of CNC12, but using the 2D top down XZ view. The new Lathe part graphics now read tool vector orientation from the tool library as well and you can now zoom in and out and pan while the machine is running and use the graphics tools to show/hide material size, travel limits, work envelope, rapids etc. while the job is running. **Requires a v5.4 Pro or Ultimate license**

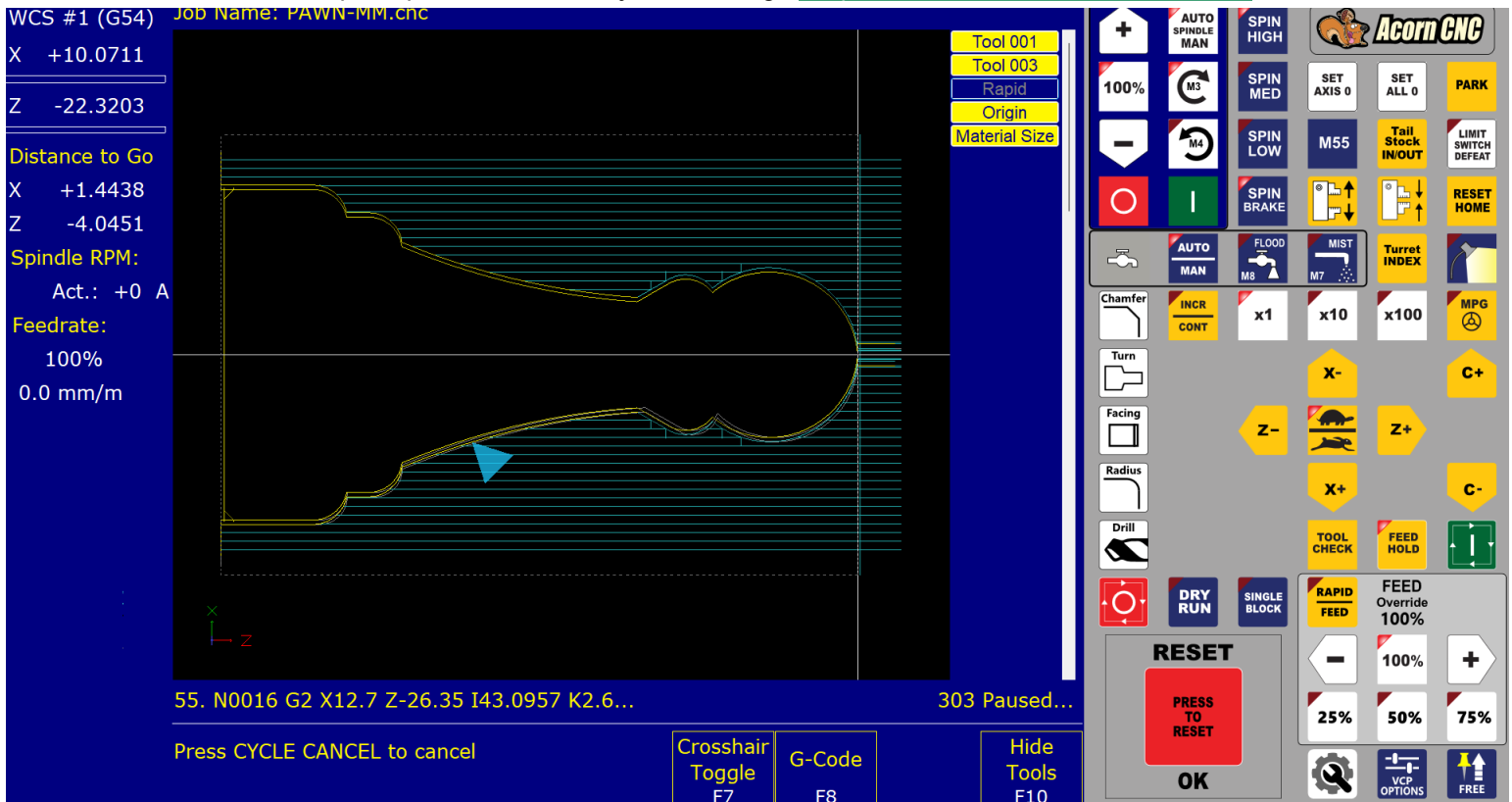

F4 Run, F2 Search → line 54, F10 Accept, cycle start. Rapids set to do not display, Origin set to display (white cross hair), Material Size set to display (dashed line). Zoom in and Pan while running the job.

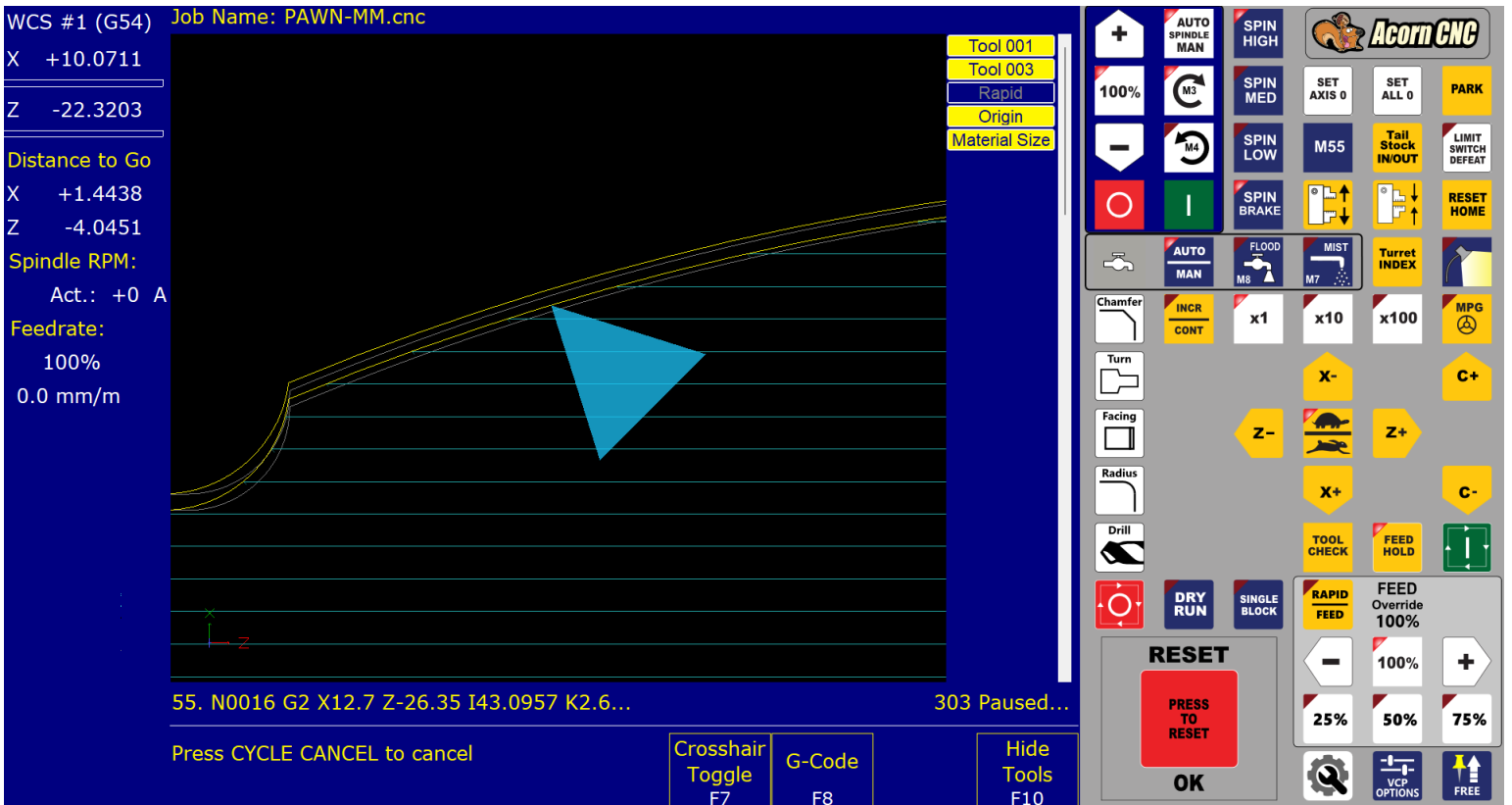

Tool Position is live in the G code backplot so you can see current tool position relative to part program. Jogging in the graphics menu will reflect the cutter position live.

T=00:05:05 Job Name: PAWN-MM.cnc

X

-20

-10

0

10

20

(G54)

-40 -30 -20 -10 0 10 Z

Set Range F3 Dimension Menu F4 Redraw F5 Options & Help F6 Zoom In F7 Zoom Out F8 Zoom All F9 Show Tools F10

Acorn CNC

AUTO SPINDLE MAN SPIN HIGH SET AXIS 0 SET ALL 0 PARK

100% M3 SPIN MED M55 Tail Stock IN/OUT LIMIT SWITCH DEFEAT

M4 SPIN LOW SPIN BRAKE Turret INDEX RESET HOME

AUTO MAN FLOOD M8 MIST M7

Chamfer INCR CONT x1 x10 x100 MPG

Turn X- C+

Facing Z- Z+

Radius X+ C-

Drill TOOL CHECK FEED HOLD

DRY RUN SINGLE BLOCK RAPID FEED FEED Override 100%

RESET PRESS TO RESET OK

25% 50% 75%

VCP OPTIONS FREE

23. Wireless Touch Probe Support, P11, P18, P44, P257, P540, and P541 now have an output or memory bit value (60000+). **requires a v5.4 Pro or Ultimate License.** This new wireless touch probe and tool setter support allows the existing CNC12 probe parameters to have an output or memory bit associated with them so that information can be used by the PLC program to do “wireless probe stuff” like figuring out if the wireless Probe and Tool setter is currently awake and ready to go before running a probing cycle.
  
24. In-process axis position adjustment from external source. Use a MPG/Scale/Encoder for real time position offset adjustment for any axis with M291 offset cancel or keep. This features allows on the fly axis position adjustment/ correction by the operator, typically used for Z height adjustments such as Flame Torch height tweaks while cutting but, also has other applications such as following a pattern or template with the pattern/template data being feed into the Centroid Encoder port via/ encoder or scale. Feature **requires a v5.4 Pro or Ultimate License**
  
25. Adaptive Feedrate Modulation based on Spindle RPM. As the spindle RPM varies the machine tool Cutting Feedrate will slow down or speed up to keep the chip load the same. Feature **requires a v5.4 Pro or Ultimate License.** P078 bit 1 (add 2) will turn the feature on. (Note: a G code to turn AFM on and off will be added in v5.5 to make this feature more convenient to use, for now you turn it on and off with the parameter).
  
26. Added Wizard canned logic for Hickory Lathe Electric ATC Turrets. **Requires a v5.4Pro or Ultimate License**
  
27. Improvements and additions to G-Code Backplot, new Display Options menu.  
graphic goes here.
  
28. Added 'Output Preferences' page to wizard which allows a global command for each output to be issued automatically. Choices for Automatically Activate Output upon Job Start or Job End or Both or M code control which is the default mode.

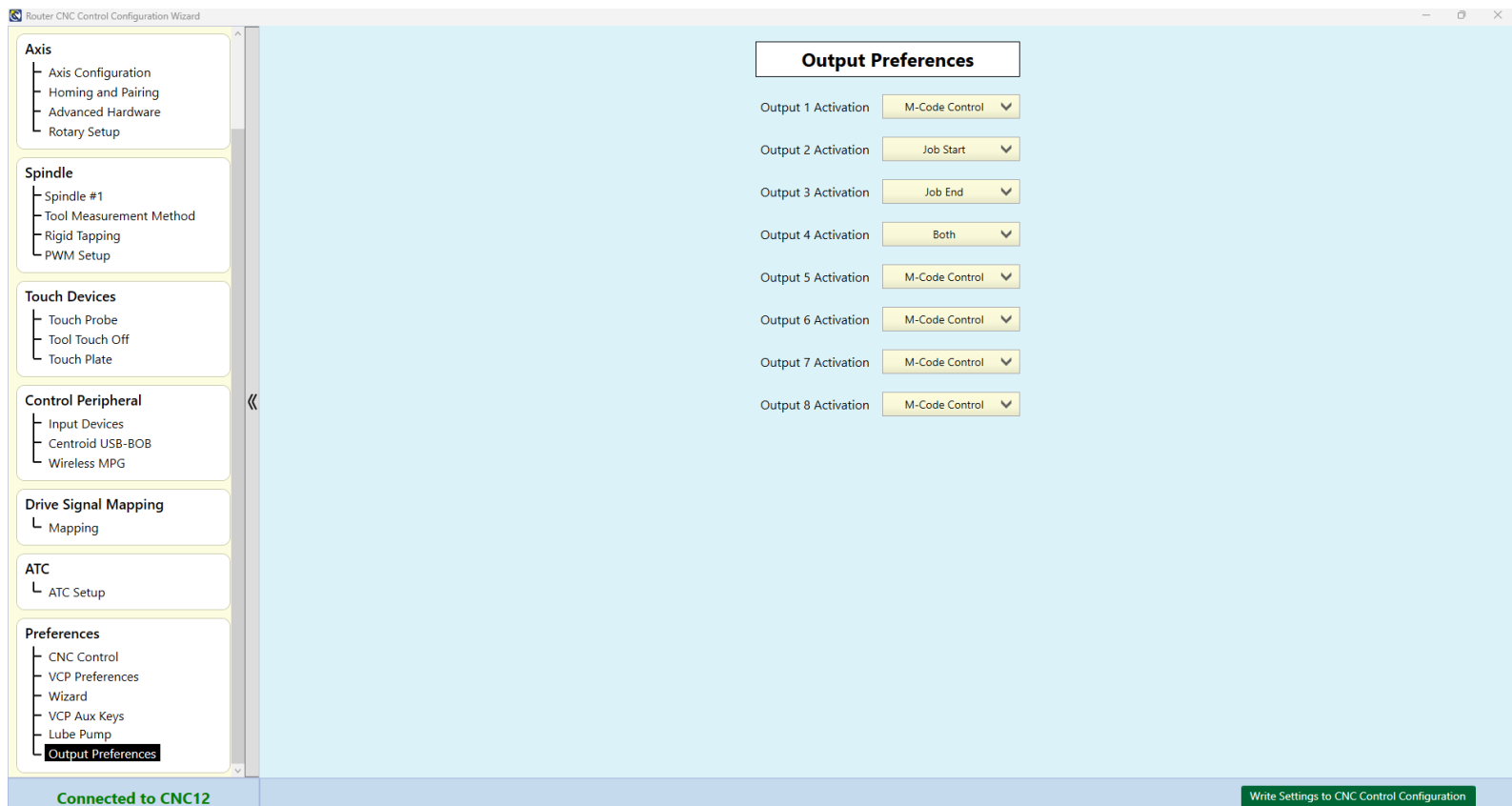

29. Centroid API improvements and changes to facilitate complete CNC12 UI replacement as well as better performance for all Apps using the Centroid API. Enhanced Centroid API speed/responsiveness improvements. This base architecture change improves any app or feature that uses the Centroid API. Such as: "CHIPS", Paper Tools, Centroid VCP, Centroid CNC setup Wizard, Centroid Plasma Restart Mode, Centroid input/output diagnostic screen. Plasma/Laser Material profile manager and more.

#### Calls Added

- State.GetConsoleType
- State.SetConsoleType
- WCS.SetWorkpieceLocation
- Job.SetSystemVariable
- Axis.GetPower
- System.GetHighestLicenseVersion
- Tool.SetToolHeightOffsetAmount (fixed typo)
- Tool.SetToolDiameterOffsetAmount (fixed typo)
- Tool.Save
- InboundComm.ChangeDroType

#### Calls Deprecated

- State.SetPlasmaInterruptPoint. Restart mode graph no longer displayed within CNC12
- Job.Load(string path, string cnc12\_working\_directory). Function created a file as a "dead drop" for CNC12 to load. This causes a race condition with the improvements introduced in R19862-R20434
- Tool.SetToolHeightOffsetAmount. Typo in function name
- Tool.SetToolDiameterOffsetAmount. Typo in function name
- State.IsPCPoweringOff. Preferably handled via the outgoing pipe

#### Improvements

- Job.LoadJob and Job.RunCommand have overloads that do not require the working directory as an argument
- Fixed bug where Tool.GetHeightOffsetAmount would always return H1 rather than the active H value if no H value was specified
- Job.CancelExecution will issue the "Escape" key for the emulator/offline intercon install
  - Added dedicated support for Visual Basic via VB\_[class] classes to resolve ambiguity between class and class instance
- Fixed bug where WCS.SetWorkpieceOrigin was not working
- Added ERROR\_LICENSE\_LOCKED error code
- Restructured pipeline/packets between CNC12 and the API to reduce time complexity. Total Wizard write time reduced from 10.77 seconds to 1.11 seconds
- Added outbound data pipe from CNC12 to the API with queue and message handlers which facilitate real time data with no request necessary. (you can pipe data directly to an element without having to ask for it)

#### Communication Types are

DRO\_UPDATE

Sends the coordinates of the dro as a double array (8)

CNC12\_SHUT\_DOWN

Sends whether CNC12 is shutting down gracefully. A crash of CNC12 will probably not send this message

PC\_SHUT\_DOWN

Sends whether CNC12 has triggered a shutdown of the PC. A half second sleep is enacted in CNC12 after this message has been sent

MESSAGE\_WINDOW\_MESSAGE

Sends a message as it's printed in the message window

An event handler needs to be attached to CNCPipe.MessageReceived and CNCPipe.StartListening called to begin to receive messages from the outbound pipe.

CNCPipe.StopListening can be called to no longer receive messages.

CNCPipe.ClearUnhandledMessages and CNCPipe.TryPopUnhandledMessage can be used to access the last 1000 unhandled messages (messages where e.Handled == false). It is estimated that 1000 messages is roughly the last 30 seconds of dro updates/CNC12 message window messages.

Speed tests show that updating the dro of a test app via requesting the information through Dro.GetDro resulted in an updated value every 4 ms whereas getting the same information through the outward pipe from the DRO\_UPDATE communication type resulted in an updated value every < 1 ms!

CNC12 Outbound communication will now report current job info: Current line number, stack level, and running job

Added API call Job.GetCurrentlyRunningJob(out string current\_job) which will return the current running job, subprogram, api command, mdi, or no job running.

On going Centroid API support and user development discussions are here.

<https://centroidcncforum.com/viewforum.php?f=72>

30. Added a new App SystemVariableViewer.exe to the CNC12 installer. Provides real time system variable viewing.
31. CNC12 will now use Windows Clipboard for its copy/paste operations
32. Reconfigured the Color Picker to be more useful search so it searches for color description names (instead of profiles).
33. Removed Plasma-Router Swap from installer, as it is no longer relevant since cnc12 now installs in it own directory for each variant.
34. Plasma Profile Manager will now prompt to select a profile set on first launch.
35. Added parameter 523 bit 8 (Add 256) to be able to invert the thc touch input (SV\_THC\_TORCH\_TOUCH)

36. Dimension Menu - F3 button "Goto line" will now highlight, center on, and zoom into the selected line
37. Dimension Menu - F4 button "Measure" will now train the starting point cross hair on the mouse until the mouse is clicked (Left button down). At this point, the starting point will be anchored at that location and the ending point cross hair will be trained on the mouse.
38. Misc. improvements to the CNC12 G code program Backplotter. Such as Fixed bug where Next and Prev Line buttons in the dimension menu were not working, improved
39. Rearranged information on the RTG screen to better accommodate longer file names
40. Added the ability to control the attributes and dimensions of parameters 700-799 (OEM feature). This is done through the new file parm\_attrbs.xml in the form of:
 

```
<parameters>
  <parameter>
    <number>700</number>
    <dimension>1</dimension>
    <attribute>0</attribute>
    <axis>-1</axis>
  </parameter>
</parameters>
```
41. You can choose whether you want the old backplot for RTG or the new dynamic graphic engine. P150 bit 7 (add 128) will now allow the backplot (F8 Graph) to be used for RTG. **Note: Old license = old graphics engine, a v5.4 license = new graphics engine or old your choice.**
42. Acorn: Added a timer to Unclamping tool that will fault the system, more inline with the Hickory/Oak PLC logic
43. Acorn: Added Check in M6 Tool Rack Macros to check for if Tool is in spindle
44. Acorn: Added Drawbar Up Output (Unclamp the Tool), Drawbar Up/Down Inputs for compatibility with certain types of ATC spindles. When both Drawbar up/Down are off, it is considered to have a Tool in spindle (Tool prohibits drawbar from reaching down position). Drawbar Up is unclamp, Drawbar down is Clamp without tool
45. Added string variable #401 to allow for custom error messages. Setting the variable to a non-empty string will display the string as an error message and cancel a job.
46. Added #25033 to give license levels, Free = 0, Pro = 1, Ultimate = 2, Ultimate Plus = 3
47. Fixed bug where "Do not use Machine Home" wouldn't stick in the wizard
48. Fixed a bug with P424 that caused the new PWM delay feature to only be applied when changing from a zero to non-zero spindle speed
49. Fixed a bug that would cause a crash when trying to backplot a job using M293
50. Fix a bug in CNC12 that would cause the license file not to register when it takes a long time for the control board to communicate with CNC12
51. Added Checks to Axis\_Calibration macro for when the Distance Moved is near zero or if the input measurement is zero, both of which would result in errors in pitch calculations.
52. Updated the part\_zero\_auto\_z macro to allow the Centroid DP-7 Probe to work when setting Z Part Zero
53. Updated parameter descriptions for P406 and P407
54. Added a fix for Ethercat Drive Leadshine EL7 "failed start up" (symptom: high load meter, no motion)
55. Added Checks to ensure set\_laser\_csr macro sets the angle properly. Ensures the angle is between 90 and -90 degrees. Macro now also assumes the "longer distance" side is the side your measuring, so if measuring the side in Y-Axis 90 degrees is factored in properly for the CSR Value
56. Fixed a bug where attempting to command a move to the current position would cause paired axes to

- get out of sync when used in conjunction with M221-225
57. The CNC12 installer will now backup the intercon and icn\_lath directories as well.
  58. CNC12 Router: Corrected a typo in touch\_plate\_cycles\_select for the Bore Cycle that used the first axis position for the second axis, resulting in unwanted movement
  59. Fixed a bug where jobs would pause when transitioning from a linear (G1) move to a rapid (G0) move when using a feedrate override greater than 100% when there was no commanded movement between the two lines.
  60. Added Checks to Axis\_Calibration macro for when the Distance Moved is near zero or if the input measurement is zero, both of which will result in errors in pitch calculations
  61. System variable #25014 will now return a 3 for Router and a 4 for Plasma
  62. System variable #400 will return a string of the current install directory (C:\cncm, C:\cncr, etc.)
  63. Removed Parameter 219 as the vcp is now controlled via the control configuration menu
  64. In the CNC12 control config menu, we separated the feature "Press Cycle Start twice to start a job" from "Jog Panel Required" so you can choose them individually.
  65. Fixed bug where wizard would display a fatal error if outputs were not defined and jtech laser configuration presets were used
  66. Removed Parameter 5 bits 0 and 1 as Home In Place is now an option in the CNC12 control configuration
  67. probe\_cycles\_history.txt will now record length of slot/web probe move in both X and Y directions if applicable
  68. Added a reassurance message to the startup screen of CNC12 to indicate that the USB-BOB system is being set up
  69. Fixed a bug where the disconnect warning message for USB-BOB would not show up in the message window properly.
  70. Fixed a bug where inverted USB-BOB inputs would trigger when hot swapping the USB-BOB
  71. Fixed a bug that prevented the simplified PLC Diagnostic Screen from maintaining focus when swapping between board (Acorn/AcornSix/Hickory) and USB-BOB IO
  72. Improved setup process and messaging during the USB-BOB setup for better UX.
  73. Added Paper Tools App Support. More info here. <https://centroidcncforum.com/viewtopic.php?p=98634#p98634>
  74. PWM Power Floor % and P815 (Add4), adds yes/no toggle for "Only Apply Floor During PWM Velocity Modulation Moves"
  75. Updated Hickory PLC to include C-Axis Enable output for C-Axis style that uses a clutch or gear to engage the motor to spindle. mfunc51 corrected for hickory memory bits.
  76. Changed auto\_z VCP button to directly call the touch\_plate\_z\_zero.cnc macro. This button was the predecessor to the auto\_z\_plate button.
  77. Added "Material Size" to Mill/Router Intercon so user can specify material size to be displayed in the G

code backplot graphics and RTG screens.

78. Added in version v5.4 we introduced a new parameter that helps the WMPG client run on slower/older computers.

Parameter 414 "Wireless WMPG Sleep Rate" to control how often the wireless mpg client sends data (in milliseconds) to CNC12 which will reduce the cpu usage of the wireless mpg client. Only intended for certain PC's that exhibit excessive CPU usage with the Wireless MPG client. It is not recommended that this value exceed 300 milliseconds (a number this high will cause a delay in wheel movement to actual machine movement) Default value = 1 millisecond. Our in house testing with a 'good' computer showed that we could go up to 100 without seeing any noticeable lag in the wireless WMPG performance from a user standpoint. If you have to set this number higher than 150 to get the CPU useage down the issue is most likely a PC /Windows issue. Lower number = fastest update rate for best WMPG performance. Use a good computer.

If you have an older slow computer and the MpgClient.exe is using a lot of CPU resources try P414 = 50 or 75 this range is a good compromise between WMPG responsiveness and reducing the CPU usage.

If you are still having issues Follow the WMPG trouble shoot guidance here.

<https://centroidcncforum.com/viewtopic.php?t=10632>

79. Fixed a WCS lockout bug that was not locking out WCS origin values.

80. Better DRO Decimal place control. Parameter 263 for number of decimal resolution is now used in place of the bit that used to control this in Parameter 143. With P263 you can now you can just type in how many decimal places you want on the DRO display resolution.

81. Updated the CNC12 Mill and Router Part Menu seek Z zero with touch probe macro to retract the probe off the probed Z zero surface by the value of parameter 13 "Probing Recovery Distance" (default value is .050"/1.27mm) from the surface if the probe is still tripped after the initial probe clearing move. Note: The macro will keep track of the probed surface location even in the case of the additional clearing move, so when operator defines the touched surface location using the menu the surface WCS is set properly to the probed surface even though it is above that surface.

82. Centroid System Variable Viewer Tool. Great for debugging custom macros.

Press <CTRL W> to launch

Alternative, launch from c:\cnc?\SystemVariableViewer.exe

The screenshot displays a CNC control interface with the following elements:

- WCS #1 (G54) Current Position (Inches):** X: +4.5211, Y: +3.9301, Z: -0.0035
- Job Information:** Job Name: sample\_atlanta.cnc, Program # 20005, Tool: T1 H1, Feedrate: 100% 0.0 ipm, Spindle: 0 A, Rapid Rate: 100%, Part Cnt: 0, Part #: 0, Time: 0:04:32
- Job Status:** 303 Paused..., 307 Operator abort: job cancelled, 302 Moving..., 306 Job finished
- Distance to Go:** X: +0.0000, Y: +0.0000, Z: +0.0000
- Machine Coord.:** X: +4.5211, Y: +3.9301, Z: -0.0035
- Centroid System Variable Viewer Window:**

Variable #	Variable	Value	Description
4120	1.00000	1.00000	Tool Number (T)
4109	3.00000	3.00000	Feedrate (F)
4119	3.00000	3.00000	Spindle Speed (S)
4203	1.00000	1.00000	Tool In Spindle
10000	0.00000	0.00000	Active H Height Offset Amount
101	4.11261	4.11261	User Variable
102	3.93006	3.93006	User Variable
103	0.40845	0.40845	User Variable
104	0.00000	0.00000	User Variable
- Control Panel (Right):** Includes buttons for AUTO SPINDLE MAN, SET WCS XY0, SET WCS Z0, Auto Z to PLATE, PARK, SET Rotary WCS, SCREW PRESENT, GOTO WCS XY0, LIMIT SWITCH DEFEAT, LASER ON/OFF, RESET HOME, AUTO MAN, DUST Collector, Hold Down VAC, Air Blow, Change TOOL, INCR CONT, x1, x10, x100, MPG, 4th+, Y+, Z+, X-, X+, 4th-, Y-, Z-, SINGLE BLOCK, TOOL CHECK, FEED HOLD, RAPID FEED, FEED Override 100%, 25%, 50%, 75%, RESET (PRESS TO RESET), OK, VCP OPTIONS, FREE.
- Function Keys (Bottom):** Set Part Zeros (F1), Load Job (F2), MDI (F3), Run Job Options (F4), Tool/ATC (F5), Edit G-code (F6), Utility Menu (F7), Graph Job (F8), G-code Smoothing (F9), Shut Down Menu (F10)

83. Wizard Rotary Overall turns ratio Units are in “degrees per turn” whether you are in mm or inch mode. got a 10:1 table? then your degrees per rev is = 36, got a 360:1 table? then the degrees per rev = 1 . 90:1 the degrees per rev = 4 etc..

### Axis Configuration

	Axis 1	Axis 2	Axis 3	Axis 4
Linear or Rotary	Linear ▼	Linear ▼	Linear ▼	Rotary ▼
Label	X ▼	Y ▼	Z ▼	A ▼
Steps / Revolution	1600	1600	1600	1600
Overall Turns Ratio <span style="font-size: small;">?</span>	5	5	5	4

**CNC Control Configuration Wizard: Info**

**Overall Turns Ratio Help Screen**

When in Inches:

- Linear Axis Overall Turns Ratio units are "turns per in." - How many turns of the axis motor does it take to move the linear axis 1"?
- Rotary Axis Overall Turns Ratio units are: "degrees per turn" - How many degrees does the rotary axis move when the axis motor is turned one revolution?
- Tangential Knife Overall Turns Ratio units are "turns per revolution" - How many turns does the Tangential axis move when the axis motor is rotated one revolution?

When in MM:

- Linear Axis Overall Turns Ratio units are "mm per turn" - How many mm does the linear axis move when the axis motor is turned one revolution?
- Rotary Axis Overall Turns Ratio units are: "degrees per turn" - How many degrees does the rotary axis move when the axis motor is turned one revolution?
- Tangential Knife Overall Turns Ratio units are: "revs per turn" - How many revolutions of the axis motor results in one Turn of the Tangential axis?

Related further reading:  
 Acorn/AcornSix users "[Steps per Revolution and Overall Turns ratio](#)"

**Note:** When upgrading from older version of CNC12, DO NOT just type in the old inch number that was in the units of “turns per degree”. Please use the new unit of “degrees per turn”.

1. Fixed bug where CNC12 would crash due to the outpipe sending job information if the stack level increased while running an internal macro
2. RTG with Rotary Axis and multiple WCS locations in same G code: Fixed bug where a rotary axis WCS value would appear incorrect in 3D RTG when WCS is changed in Job via G54, G55, etc.
3. Fixed License version information reporting in the Report.txt file included in the report.zip file.
4. Windows 11 CNC12 Start Up improved due to Microsoft change: Selecting "Start CNC12 at Startup" will now schedule a task to launch cnc12 on user login instead of setting a start up application in the registry keys. This is done to get around Microsoft's decision to add a 90 second delay to startup applications in Windows 11
5. WMPG Performance Mode has been deprecated. Removed Parameter 855. WMPG performance mode has been set to "Quick Response" permanently as the other MPG profiles are no longer needed and have been deprecated.
6. Keyboard Shortcuts: ProbeCyclesHistory.exe won't launch via keyboard shortcut if the spindle is in manual mode or if the spindle is running. SystemVariableViewer.exe won't launch via keyboard shortcut if the spindle is in manual mode. This is done to solve keyboard shortcut conflicts between "Keyboard Jogging" and CNC12 utility applications
7. Lathe: Fixed bug hitting a tool check during a lathe job, going into the tool offset menu (F2), saving (F10), a crash would occur
8. CNC12 Menu display: Fixed bug where a free license would append "v5.3" token
9. CNC12 Menu display: Fixed bug where only one digit of the patch version (v5.40.X) appeared
10. CNC12 API: Fixed an issue where the api call PLC.SetWatchList would fail after a number of inputs/outputs/memory bits were added to the watch list. The number of bits that would cause failure varies board to board. The call now allows up to 255 bits to be added without issue. This number can be increased in the future if needed.
11. Hickory: Fixed case where a Rotary Job only performs 51R ( $2^{31}$  in motor counts) and would stop.  
<https://centroidcncforum.com/viewtopic.php?t=12108>

1. Added validation to P263. Values must be between 1 and 12. Default is 4. This fixes issues with double formatting (seen in the dro and mini coord displays)
2. Fixed bug where status window would not update if machine was not homed
3. Added a splash screen for starting CNC12 on startup so users know CNC12 is waiting on OS to fully boot before starting.

## v5.40.03 Build Notes

- Note: - there was no public release of v5.40.03.  
- all these items below are included with the release of v5.40.04

1. PLC Detective now stays on top of other applications
2. Reports will now include all .mac files located within the system folder
3. Eliminated the start up splash screen for OS boot up finish and added new technique "Focus WatchDog"
4. Added "Focus WatchDog" that will keyboard maintain focus on CNC12 if "--exclusivefocus" is specified. This will remain on until an application is launched from CNC12. The Windows Key will toggle this on and off
5. Added WMPG power off reminder to when CNC12 triggers a shut down of the PC
6. Fixed a bug where the automatic resync or resync prompt (see P579) would not resync paired axes after restoring power to the motors
7. 3D RTG graphing will ignore the feedrate override percentage while drawing the part
8. Fixed bug where using arrow keys would crash the utility menu
9. Added "--fullscreen" as a startup argument. Should be used for 4:3 monitors only
10. Added antivirus detection and identification to the report.txt file for antivirus software that registers in the Windows Security Center
11. Added a PipeDisconnected Event Handler to the API
12. Added a timestamp to all outbound CNC12 API packets
13. Fixed bug where Lathe status window part count would overrun the program number
14. Added "Job Concluded" packet to the outgoing CNC12 communication
15. Fixed bug where AcornSix wizard would always overwrite the plc, regardless if custom plc was selected
16. Alt+M MDI will now work in the PID Encoder menu
17. Fixed bug where Centroid API would continue to propagate messages after CNC12 shutdown
18. Fixed bug where the graphics tool marker would appear in a different plane if the tool height offset changed during the job (H value, not H number)
19. Fixed bug where not having a tool loaded on a metric machine and using the tool library for graphing the tool marker would result in a very thin tool marker.
20. Fixed bug where toggling the advanced i/o display on and off while the g-code display is running would not redisplay the g-code
21. Fixed bug where measurement amount (F8 >> F4 >> F4) would be cutoff if the taskbar was hidden

- Fixed bug where the CNC12 PLC Diagnostic tool would not update with the color picker colors for Router and Plasma
- P404 will now return Z to G28 position after Tool Change during batch tool measurements
- P4 Bit 4 (add 16) which remembers the last open directory will now only apply to loading job files (F2 from the main screen)
- Fixed a bug where pressing "F8" while a MDI command was in progress would crash CNC12
- Fixed a bug where using Centroid API call Job.RunCommand and then pressing "F8" would crash CNC12
- Added overload to Centroid API call Dro.GetDro which will return axis positions as a double rather than tuple strings if the machine is homed. The return code for an unhomed machine is "ERROR\_NOT\_HOMED"
- In the wizard, changing the Max Rate value for a given axis to a number lower than the Fast or Slow Jog rates will clamp those rates to the new Max Rate
- Updated names of the CNC12 Color Picker. Graph Spindle Location and Tool Indicator color updated to #00FF00 for the Centroid Classic color profile
- Fixed some issues with the "Watchdog Enabled" pop up message box displaying on a Windows 11 machine
- Allin1DC/Oak systems: When P44 and P257 are zero, If a probe is not actively detected then the Tool Auto Measure will default to a TT using the probe input (P11)

- improvements to the CNC12 Focus Watch Dog. Used for M400/T400 consoles to force CNC12 to always have Windows focus and alert user if focus has been taken away (and restored by the watch dog) Introduced for certain Windows installations that seem to have focus issue due to various non Centroid apps running. If you have a console with focus issues give this a try, if not no need to use it. There is a check box that gives you a choice to use it or not when you run the CNC12 installer.

CNC software is now available for use with Acorn, AcornSix, Hickory, Allin1DC, Oak and MPU11. Please [Follow the installation instructions](#). Do not use “restore report” using a report from an earlier version.

Download CNC12 v5.30 here.

[https://www.centroidcnc.com/centroid\\_diy/centroid\\_cnc\\_software\\_downloads.html](https://www.centroidcnc.com/centroid_diy/centroid_cnc_software_downloads.html)

This is a free CNC software update! All previous license files file work with this new version of CNC12 software (in their respective categories: Acorn mill licenses work with Acorn mill, Oak lathe licenses work with Oak lathe CNC12, etc.)

#### v5.30

a.) Fixed a Wizard bug introduced into the Wizard Axis menu Overall Turns ratio max rate calculation warning for Rotary axis

b.) Fixed G540 “Legacy mode” support for Acorn. G540 Legacy mode = running Acorn inputs and outputs through the G540.

c.) Fixed Smoothing Function key typo for the F key label introduced in v5.28 when updating the text in CNC12 for clarity.

#### v5.28

1. Updated several instances of unclear wording related to G-code Smoothing Menu (F1) and other CNC12 Software messages.
2. Fixed: a bug in the Wizard where the max rate for an axis in a metric system was being calculated in imperial units
3. Fixed: a bug where the beta volumetric compensation feature would not unlock under a trial license for Hickory/Oak/Allin1DC/MPU11
4. Fixed: a bug where the Wizard wouldn't allow an axis labeled C to be set to Rotary.
5. Fixed: Tool Offset Set Z Ref device selection to be the same as Part Zero and Tool Offset Auto Measure macros
6. Updated: Part Zero, Tool Offset Auto Measure, and Tool Offset Set Z Ref macros so if P44 (Tool Touch Input) was set to the same value as P11 (Touch Probe Input), it will still ask if you want to use a Probe or Tool Touch
7. Fixed: bug where WCS nicknames wouldn't save for Oak/Allin1DC/MPU11/Hickory Platforms
8. Fixed: bug where SetSkinningData...Word(..) API calls were not working

9. Added Wireless Probe Support: Probe Protection support for Outputs and Memory bits. This allows P011, P018, P044, P257, P540, and P541 (Probe, TT, and Touch Plate) to use Outputs (60000s) and Memory bits (70000s) provided that an Ultimate license is applied. Notes: Mainly intended for Wireless CNC Touch Probe support of a detection, “im alive ready to go” input. Not intended for use with the actual Touch Trigger input.

CNC software is now available for use with Acorn, AcornSix, Hickory, Allin1DC, Oak and MPU11. Please [Follow the installation instructions](#). Do not use “restore report” using a report from an earlier version.

Download CNC12 v5.26 here.

[https://www.centroidcnc.com/centroid\\_diy/centroid\\_cnc\\_software\\_downloads.html](https://www.centroidcnc.com/centroid_diy/centroid_cnc_software_downloads.html)

This is a free CNC software update! All previous license files file work with this new version of CNC12 software (in their respective categories: Acorn mill licenses work with Acorn mill, Oak lathe licenses work with Oak lathe CNC12, etc.)

1. Fixed a bug in v5.24 CNC12 causing the new M297 (defeat soft travel limits) to remain active even after terminating a job and/or exiting MDI.
2. The Wizard now accepts “degrees/rev” as units for the Overall Turns Ratio for rotary axes in both imperial and metric.
3. Added information buttons to the Axis Configuration menu in the Wizard to help explain the units of certain axis parameters.



4. Removed Skip Macro if searching line in M50/M51 macros for Acorn, Acornsix, and Hickory. This allows Run Search to find the M51 command for C-Axis Moves, if the macro was skipped this would have resulted in an invalid axis error for C-Axis.
5. Fixed faulty Smart Search options parsing for Lathe
6. Wizard i/o: Renamed ChipPumpOut to “WashDownOut” for Hickory. PWMOutput was also hidden for AcornSix as it applies to Acorn only, AcornSix has two dedicated PWM outputs so no need to have this output in the i/o assignment drop down.
7. Fixed any Wizard Tooltips that didn’t have text or had vague text
8. Fixed a bug where rotary feedrates below a certain threshold would not display on the DRO.

9. Added Slider in the Wizard Rotary Setup Menu to choose whether or not to use a Fixed Position (in machine coordinates) for a Rotary Table or just display and run the Rotary Job at the current (any) WCS location.

**Rotary Setup**

Rotary Axis A

Axis Parallel To Rotary Center Line

Rotary Axis Jog Increment  degrees (P041)

Rotary DRO Display Type  Rotations

Slave Rotary axis feedrate to a linear move feedrate on the same line\*  No (P002)

Rotary-only moves won't use a modal feedrate set by a prior rotary and non-rotary move\*  No (P002)

*\*This feature has no effect for movement commands handled by Smoothing (P220=1)*

---

Use a Fixed Rotary Table Position on Machine  Yes  (P268)

Center of Axis (Y) in machine coordinates  (P116)

Center of Axis (Z) in machine coordinates  (P117)

Allowable error threshold between Rotary Part Zero Position (WCS) and Machine Coordinate Fixed Position Rotary Center-line position  (P269)

Added P268 (Fixed Rotary Table Position) and P269 (Rotary Center-line Threshold) to CNC12. P268 determines whether the software should account for the center-line coordinate parameters (P116-119) when graphing a rotary job, and P269 sets the maximum allowable difference between the current rotary WCS and the center-line coordinates. If the users current WCS is not set within the P269 value of the Rotary Table Center then CNC12 issues a warning message stating this.

If the Slider is set to NO there is no warning message and the G code job will simply graph and run where ever the WCS is set.

Use a Fixed Rotary Table Position on Machine  No  (P268)

Center of Axis (Y) in machine coordinates  (P116)

Center of Axis (Z) in machine coordinates  (P117)

Allowable error threshold between Rotary Part Zero Position (WCS) and Machine Coordinate Fixed Position Rotary Center-line position  (P269)

10. Fixed bug where the CNC12 installer for Oak and Allin1DC Lathe would also harmlessly install CNC12 Router version of CNC12.
11. Parameters 571-578 (Max Scale Difference for each axis that is using a scale for positioning) are now applied to each individual axis instead of only using the value from P571 for all.
12. Fixed a bug where the probe indicator graphic would not display NC probes correctly when P18 (Probe Detect) was set below -50,000.

CNC software is now available for use with Acorn, AcornSix, Hickory, Allin1DC, Oak and MPU11. Please [Follow the installation instructions](#). Do not use “restore report” using a report from an earlier version.

Download CNC12 v5.24 here.

[https://www.centroidcnc.com/centroid\\_diy/centroid\\_cnc\\_software\\_downloads.html](https://www.centroidcnc.com/centroid_diy/centroid_cnc_software_downloads.html)

This is a free CNC software update! All previous license files file work with this new version of CNC12 software (in their respective categories: Acorn mill licenses work with Acorn mill, Oak lathe licenses work with Oak lathe CNC12, etc.)

1. Updated Mill and Router F7 Auto Zero Part Setup menu with improvements.

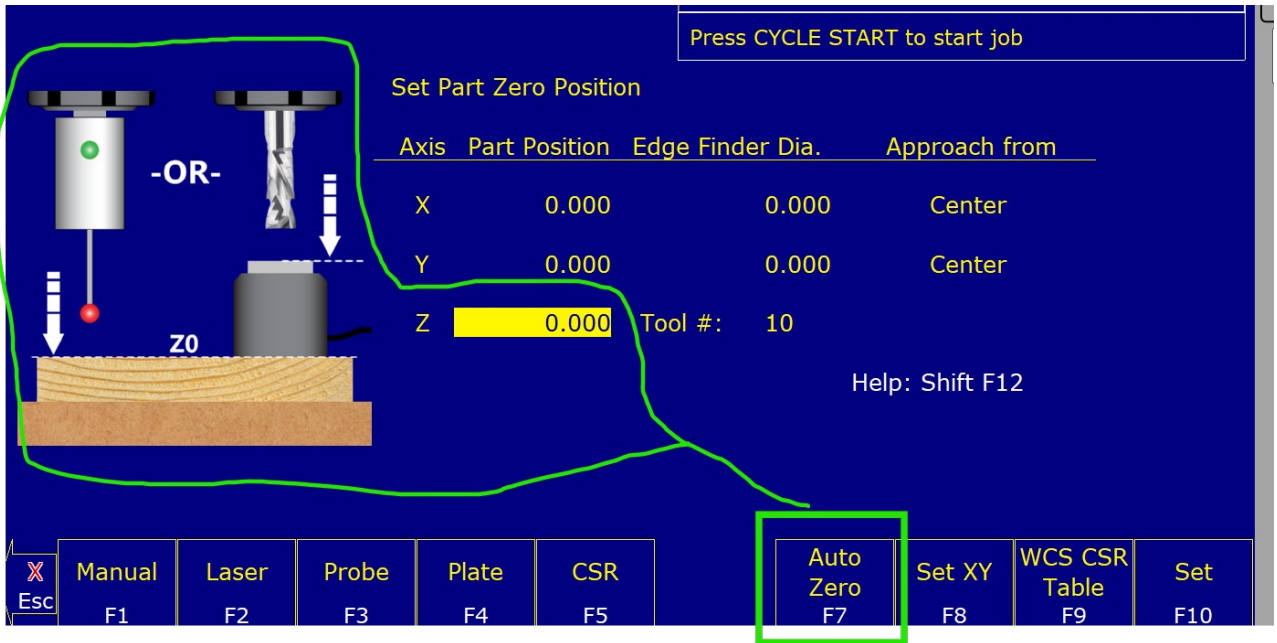

F7 Auto Z zero will now trigger off any type of Probe Input definition. Useful for using a TT to set Part Z zeros. Either the Probe or the TT or Touch Plate can be used with F7 Auto Z zero menu.

Notes: If you have the TT set to subtract the TT height for tool length measurements, F7 Auto Zero will also subtract the height of the TT therefore setting the Z zero location on top of whatever the TT is sitting on.

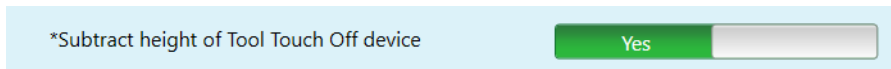

And same for a Touch Plate.

347 Reset Cleared  
490 Reset Initiated. Press Reset to Clear

Auto Z Zero

\*\*\* Choose which Touch Device to use! \*\*\*

Press 1 = Seek the TOOL TOUCH OFF  
- or -  
Press 4 = Seek the TOUCH PROBE  
- or -  
Press 8 = Seek the TOUCH PLATE

CEL to cancel

Approach from  
Center  
Center

Help: Shift F12

Manual F1   Laser F2   Probe F3   Plate F4   CSR F5   Auto Zero F7   Set XY F8   WCS CSR Table F9   Set F10

The new Auto Part Z zero macro also employs the new P0 probing cycle command argument which tells the probing cycle to trigger off of any input setup as a probe. So, for instance when probing a TT with a Touch Probe the probing cycle will use whatever input triggers first.

Note: You can always type in the TT height value here as well if you don't have CNC12 set to subtract the TT height for Tool measurement or if you desire to set the z zero at another position.

Set Part Zero Position

Axis	Part Position	Edge Finder Dia.	Approach from
X	0.000	0.000	Center
Y	0.000	0.000	Center
Z	45.000	Tool #: 8	

Help: Shift F12

In this example above the TT height is 45 mm, which sets the part zero at the bottom of the TT with "subtract TT height" set to No in the Wizard.

2. Improvements made to the Tool Library Auto Tool Height Measurement Macro.  
 C:\cncm\system\tool\_offset\_auto\_measure.cnc

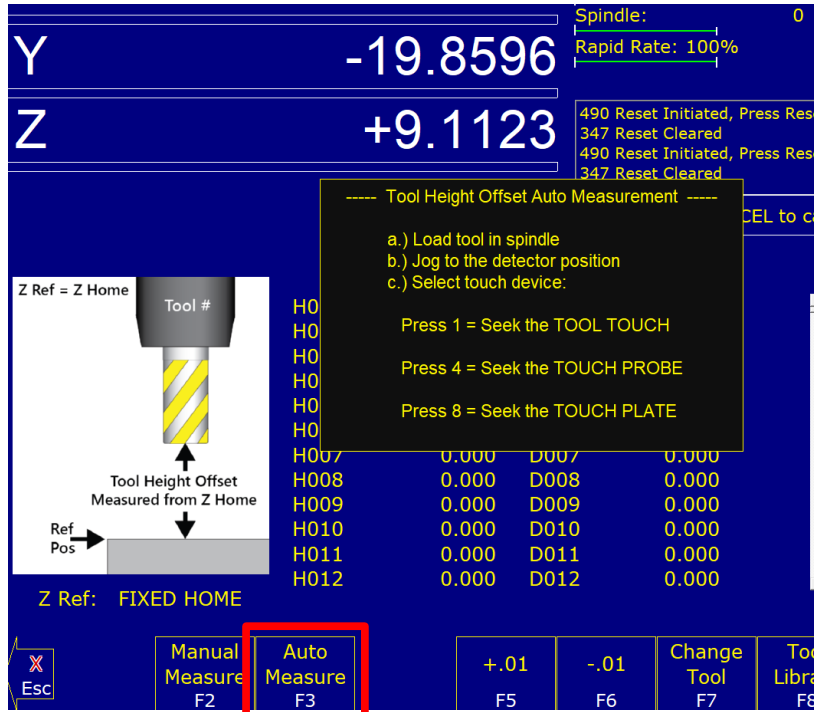

The Auto Tool Height Measurement macro (tool\_offset\_auto\_measure.cnc) will auto recognize all configured touch devices and present the operator with a choice of touch devices to use during the tool height offset measurement cycle.

The new Auto Tool Height Measurement macro employs the new P0 probing cycle command argument which tells the probing cycle to trigger off of any touch device input. So, for instance when measuring a Touch Probes Tool Height Offset with a TT, the probing cycle will use whatever input triggers first either the TP or TT.

Just like all Centroid provided macros, the tool\_offset\_auto\_measure.cnc macro is user editable so users may edit to their particular application and work flow.

Note: You can also hold the SHIFT key in the Tool Offset menu to make use of the old (previous to v5.24) F3 Auto Measure hard coded auto tool measure routine

3. Added: PWM Laser Delay Fine Tuning Parameter 424 added. Useful for compensating for millisecond delays introduced when using RAS with Clearpath servos.
4. Added new M-codes: M297 (Defeat Soft Travel Limits) and M298 (Re-enable Soft Travel Limits). The default state of the software behaves as if M298 has been called. M297 can either be called during a job or in MDI mode to temporarily defeat the soft travel limits. This lasts until:
  - M298 is called
  - MDI mode is exited
  - The job finishes (or is canceled/aborted)

Note that if M298 is used within a job, soft travel limits will be treated as active again for any subsequent moves (or until M297 is called again).

Useful for commanding special machine movements OUTSIDE the Software Travel Limits. Use with caution!

Added M297 to Wizard generated Home Programs.

5. Added M291 - Reset MPG Offset. Ultimate License required.

M291 resets any accumulated MPG offset for all axes across all MPGs, provided that PLC program "SV\_MPG\_X\_OFFSET\_MODE" (where X represents the MPG number) is active.

Example (assuming an accumulated 0.25" offset on the Z-axis):

Without M291:

G0 Z0 ; Though Z0 was commanded, the Z-axis will move to an offset position from Z0 - in this case, 0.25"

With M291:

M291 ; reset MPG offsets

G0 Z0 ; Z-axis moves to Z0 as commanded now that the MPG offset has been reset

Note: Custom PLC program interaction is needed for this feature as the PLC program is in direct control of MPG modes.

Useful for when using an MPG wheel to adjust the position of an axis on the Fly. In special CNC applications the operator can adjust the position of an axis under CNC program control using the MPG while the job is running and when the job is finished CNC12 can be commanded to cancel any offset amount that the operator added or subtracted from that axis with the MPG OR leave the offset applied.

6. Fixed bug where M115/116 P0 would not register a NO (normally open) probe without a detect tripping
7. Fixed bug with M115/116 P0 where a NC probe without a detect in combination with any other device would result in all device inputs being ignored if probe protection via tool number was not active
8. Fixed bug where user defined message would be discarded if M0 jogging was not enabled for M200/201
9. Fixed bug where M223 would power an axis motor after an M93 call for that axis
10. Fixed bug where running a job from the Run-Search menu and then reentering the menu later would result in CNC12 crashing
11. Added Centroid API call `Axis.GetPower(...)` to get the power status of a given axis.
12. Removed the on screen ESC key from the RTG screen.
13. Fixed 'bug' where fkeys would disappear not showing anything when a keyboard modifier is pressed. This occurred because CNC12 attempted to draw alternative keys but found none.
14. Removed excess space on the run time graphics screen to allow 5+ axes to fit better

15. Added option to ignore all limit switch inputs or not when homing for Acorn.

**When using Limit Switches in conjunction with Home Switches**

Ignore all Limit Switch Inputs when Homing?   No

"No" is the default and recommended setting  
"Yes" is for special applications such as when dedicated limits are used to "protect home switches"

When set to "Yes" any limit switch input triggered while homing will be ignored. Use this feature with caution. This feature is typically used when "protecting" home switches with limit switches. (limits trip first) which allows the seeking of the home switch to continue right past a limit switch.

**When using Limit Switches in conjunction with Home Switches**

Ignore all Limit Switch Inputs when Homing?  Yes

"No" is the default and recommended setting  
"Yes" is for special applications such as when dedicated limits are used to "protect home switches"

For instance NO prox limit switches wired into Input 6 in parallel and Metrol precision micro switches ran in series with Input 6

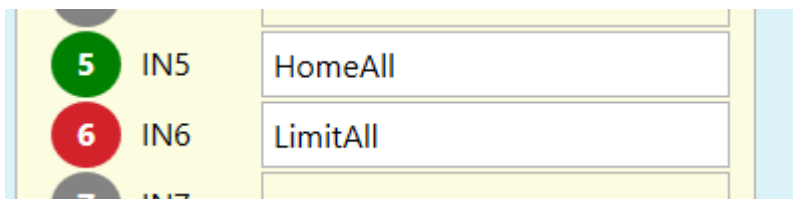

Would produce a home program like this by the Wizard.

```
;Perform Homing commands  
;Disable any assigned limit switch inputs  
M94 /105 ; disable Limit All  
M92/Z L1  
M26/Z  
M92/Y L1  
M26/Y  
M91/X L1  
M26/X
```

```
;Enable all limits  
M95 /101 /102 /103 /104 /105
```

Then you would hand edit it to reset home within the travel of the limits protecting the home switches so the software travel limits would stop the machine from hitting the limits as well.

```
;Perform Homing commands
;Disable any assigned limit switch inputs
M94 /105 ;disable LimitAll
M92/Z L1
M26/Z
M92/Y L1
M26/Y
M91/X L1
M26/X
G91 X1.000Y-1.000Z-.5000
M26/X/Y/Z
```

```
;Enable all limits
M95 /101 /102 /103 /104 /105
```

Note: This feature will be disabled (grey'd out) if any "homelimit" inputs are set. Since by definition these inputs act as both a home and a limit switch input.

### When using Limit Switches in conjunction with Home Switches

Ignore all Limit Switch Inputs when Homing?

  No

The "Ignore all Limit Switch Inputs" feature not available for use with any "HomeLimit" input definition.

FirstAxisHomeLimitOk  
SecondAxisHomeLimitOk  
ThirdAxisHomeLimitOk  
FourthAxisHomeLimitOk  
HomeLimitAll

By definition these individual inputs perform the duty of both a home switch and a limit switch so CNC12 can't ignore them.

Remove any "HomeLimit" input from the Input Definition table to use the "Ignore all Limit Switch

16. Added Centroid API calls `WCS.SetWorkpieceLocation(...)` to set wcs at a location other than zero and `Job.SetSystemVariable(...)` to set a system variable. Added some additional validation to preexisting WCS calls
17. Removed P228 (S Curve) from the ad2 presets menu as it is a deprecated experimental feature.
18. Edited the Default Router smoothing profiles "V-Carve" and "3-D Relief Fine" to have a S Curve value of zero
19. Added `ERROR_LICENSE_LOCKED` error code to Centroid API return codes for features locked behind a pro or ultimate license
20. Added PLC IO to the Report Summary
21. Fixed bug where Centroid API call `SetWorkpieceOrigin` was not working
22. Fixed bug where tool check with an unplugged NC probe would result in a probe tripped error
23. Fixed bug where swing-arm ATCs wouldn't initialize
24. Increased upper constraint of P40 for Metric to 0.0254
25. Fixed PWM2 output for AcornSix that was broken under certain combinations and made it more robust at the same time. Now AcornSix PWM2 will only turn on with the M37 (laser on) Note: The Laser feature G37 (Laser power based on velocity, aka velocity modulation) only works with PWM2 not PWM1, (think of it this way: PWM1 is for spindles, PWM2 is for Lasers)
26. The Simple PLC diagnostic menu can be launched from more (but not all) menus in CNC12
27. Fixed bug where the WCS Config menu would display incorrect function keys if a keyboard modifier was pressed
28. Upon completion of a job, the g-code display will return to the top of the file
29. Fixed bug where g-code display would require a job to be run at least once before canceling the job and displaying the last known g-code line correctly
30. Improvement: Allow non zero software travel limit when used in conjunction with screw comp.
31. Fixed a bug with Wizard related to P423 where it would let larger values than valid numbers which are: 0-255

32. Reinstated the v4.82 color schema for g-code display while running a job which was accidentally ignored when the Color Picker was introduced.

```
11. N11 M03 S5000 F15.0
12. N12 G4 P2.0
13. N13 G43 G0 Z0.05 H1
14. N14 G01 Z-0.0035 F13.5
15. N15 ; FALCONS LOGO
16. N16 G01 X8.9569 Y0. F15.0
17. N17 G01 X8.9569 Y9.9998
18. N18 G01 X0. Y9.9998
19. N19 G01 X0. Y0.
20. N20 G00 Z0.05
21. N21 G00 X3.8586 Y2.3516
```

33. Acorn/AcornSix/Hickory Wizard: add M297 to wizard generated and default home files

34. Acorn/AcornSix/Hickory Wizard Improvement to ATC Rack Mount logic made to be more flexible: M95/80 will turn off ToolRack In, M95/81 will turn off ToolRack Out

35. Plasma: M64 marking macro: Fixed undefined variable.

36. Improved the input output text report in the report.txt for better human readability.

37. Added a “maximum scale difference error” parameter for each axis. CNC12 uses this value to determine when to issue an error message. Users can now specify the maximum allowable scale to actual position error allowed before CNC12 issues a 410 fault message. P571 thru 578 571 = axis 1, 572 = axis 2, 573 = axis 3 etc.. these values are ‘echo’d” in the CNC12 scale setup menu.

Axis	Label	Input	Enabled	Scale Counts/Inch	Ratio	Deadband	Velocity	Max Diff (in)
1	Z	0	N	0.0000	0.0000	0	0.0000	0.0100
2	X	2	Y	50800.0000	0.8192	1000	0.0700	0.0200
3	C	0	N	0.0000	0.0000	0	0.0000	0.0002
4	M	0	N	0.0000	0.0000	0	0.0000	0.1000
5	N	0	N	0.0000	0.0000	0	0.0000	0.1000
6	N	0	N	0.0000	0.0000	0	0.0000	0.1000
7	N	0	N	0.0000	0.0000	0	0.0000	0.1000
8	N	0	N	0.0000	0.0000	0	0.0000	0.1000

506	0.0000	526	0.0000	546	2.5000	566	0.0000	58
507	0.0000	527	0.0000	547	0.0500	567	0.0000	58
508	4.0000	528	0.0000	548	10.0000	568	0.0000	58
509	0.0000	529	0.0000	549	5.0000	569	0.0000	58
510	0.0000	530	0.0000	550	0.0000	570	0.0000	59
511	0.0000	531	0.0000	551	0.0000	571	0.0100	59
512	0.0000	532	0.0000	552	0.0000	572	0.0200	59
513	0.0000	533	0.0000	553	0.0000	573	0.0002	59
514	0.0000	534	0.0000	554	0.0000	574	0.1000	59
515	0.0000	535	0.0000	555	0.0000	575	0.1000	59
516	0.0000	536	0.0000	556	0.0000	576	0.1000	59
517	0.0000	537	0.0000	557	0.0000	577	0.1000	59
518	0.0000	538	0.0000	558	0.0000	578	0.1000	59
519	0.0000	539	0.0000	559	0.0000	579	0.0000	59

Axis 1 Maximum Scale Difference (in, mm, or deg)

## Centroid CNC12 v5.22 Mill, Lathe, Router, Plasma Release Notes:

CNC software is now available for use with Acorn, AcornSix, Hickory, Allin1DC, Oak and MPU11. Please [Follow the installation instructions](#). Do not use "restore report" using a report from an earlier version.

Download CNC12 v5.22 here.

[https://www.centroidcnc.com/centroid\\_diy/centroid\\_cnc\\_software\\_downloads.html](https://www.centroidcnc.com/centroid_diy/centroid_cnc_software_downloads.html)

This is a free CNC software update! All previous license files file work with this new version of CNC12 software (in their respective categories: Acorn mill licenses work with Acorn mill, Oak lathe licenses work with Oak lathe CNC12, etc.)

- Fixed the CNC12 installer overwriting the WCS file and other files from an existing installation for Oak/Allin1DC/Mpu11 updates.
- Fixed bug caused by a rounding error that made slaved axes momentarily change direction that only revealed itself when trying to send a signal to Teknic Clearpaths to hard stop home all three axes at a time.
- Fixed Pages in the wizard too long to fit on a single page when printing will now be scaled down rather than cut off
- Fixed bug where G10 PXXX RYYY would write an incorrect value if a G20/21 command was issued contrary to the default units of measure for cnc12.  
This is evident in the series of commands:  
G21  
G10 P700 R4  
G65 "C:\cncm\ncfiles\tool#9700.cnc"  
which would result in tool3.cnc being called rather than the requested tool4.cnc
- Fixed bug where Plasma Intercon wouldn't launch due to missing files
- Fixed bug where Single Blocks would not set correctly out of the run menu. Also fixed functionality to match that of v5.10 when interacting between CNC12 and PLC in regards to the run menu removing F5 as an option when single block mode activated via the plc
- Fixed bug where API call Tool.GetHeightOffsetAmount would always return H1 rather than the active H value if no H value was specified
- Added API calls State.GetConsoleType and State.SetConsoleType
- Added the ability to collapse the navigation pane of the wizard. Also fixed related minimum size of the wizard to scale to a 4:3 operators LCD screen better
- Fixed bug where Lathe would not save or load smoothing presets.
- Fixed bug where jogging beyond travel limits after homing via M26 in MDI was possible
- Added some protection for startupOptions.ini to ignore blank lines and lines containing excess null terminators and other 'garbage'
- Fixed run menu resetting the part count upon entry. Part count will change upon interaction with the part count input box

- Acorn Lathe C-Axis will now require an Ultimate license. Existing Acorn C axis users are grandfathered in. email [diysales@centroidcnc.com](mailto:diysales@centroidcnc.com) for details.
- Fixed bug where cycle start wouldn't work in the run-resume menu if P400 was set to 0
- Fixed bug where homing the THC axis (Z-Axis) via switches before homing any other axis, canceling out of the homing program, and rerunning the homing program resulted in an immediate axis travel limit exceeded error
- Added diagonal buttons to the keyboard jogging legend
- Fixed bug where park.mac would install over a custom park.mac (and other similar problems)
- Added classes VB\_[class] to the CentroidAPI to resolve ambiguity between the class and class instance that Visual Basic can't overcome.
- Added bit 4 (add 16) to parameter 113 to hide the Wizard button from the Utility menu (and all other buttons that may launch the wizard)
- Fixed bug where Z Clearance Height in Router Touch Plate menu would not convert between imperial and metric when changing units
- Updated Keyboard Jog Panel legend for Lathe
- Fixed bug where keyboard jogging is enabled, a command is entered and run in MDI, MDI is exited, and the keyboard jog panel is moved resulting in keyboard jogging no longer functioning
- Fixed bug where 410 Scale error would appear upon restart of software
- Lathe G99 moves without an encoder setup will no issue a warning message. To reduce tech support related to user trying to command lathe moves without an encoder installed and configured.
- Lathe parameter 48 is defaulted to 1 to make G98 the default mode. To reduce tech support related to user trying to command lathe moves without an encoder installed and configured.
- Fixed some interactions between Keyboard Jogging and the MDI menu so keyboard jogging works better.
- Fixed omission of the Plasma Scribe menu in the wizard
- Fixed bug where the API call Job.CancelExecution would not cancel a job while using the emulator/offline intercon. This call will issue the "Escape" key for the emulator/offline intercon install.
- Fixed bug where M221 timer would end other M2XX messages if the timer expired after the message elapsed
- Fixed a Touch Plate dialog box message bug.
- Added "Laser Deploy" as an output selection in the Wizard.

## Centroid CNC12 v5.20 Mill, Lathe, Router, Plasma Release Notes:

CNC software is now available for use with Acorn, AcornSix, Hickory, Allin1DC, Oak and MPU11. Please [Follow the installation instructions](#). Do not use "restore report" using a report from an earlier version.

Download CNC12 v5.20 here.

[https://www.centroidcnc.com/centroid\\_diy/centroid\\_cnc\\_software\\_downloads.html](https://www.centroidcnc.com/centroid_diy/centroid_cnc_software_downloads.html)

This is a free CNC software update! All previous license files file work with this new version of CNC12 software (in their respective categories: Acorn mill licenses work with Acorn mill, Oak lathe licenses work with Oak lathe CNC12, etc.)

### Major Additions

1.) The Hickory EtherCat based CNC Controller now has a Centroid CNC Controller setup Wizard for Mill, Lathe, Router and Plasma versions of CNC12 which is very similar to the popular Acorn and AcornSix setup Wizard with simple drag and drop, fill-out-the-menu type CNC machine tool setup configuration. Launch the new Hickory Wizard from the CNC12 Utility menu. (Note: Use of the Wizard is not required for those that are used to configuring without.)

### Hickory Router setup Wizard Axis Configuration Setup Menu

	Axis 1	Axis 2	Axis 3	Axis 4	Axis 5	Axis 6
Linear or Rotary	Linear	Linear	Linear	Linear	Linear	Linear
Label	N	N	N	N	N	N
Encoder Counts / Revolution	1048576	1048576	1048576	1048576	1048576	1048576
Overall Turns Ratio <i>turns/in. or rev/deg or turns/rev</i>	1.25	1.25	2.5	5	5	5
Lash Comp. <i>inches</i>	0	0	0	0	0	0
Max Rate <i>in./min or deg/min or rev/min</i>	2000	2000	1000	200	200	200
Fast Jog Plus Direction <i>in./min or deg/min or rev/min</i>	750	750	300	50	50	50
Fast Jog Minus Direction <i>in./min or deg/min or rev/min</i>	750	750	150	50	50	50
Slow Jog <i>in./min or deg/min or rev/min</i>	100	100	50	10	10	10
Accel / Decel <i>seconds</i>	0.375	0.375	0.375	0.5	0.5	0.5
Direction Reversal	N	N	N	N	N	N
Drive Enable Delay <i>milliseconds</i>	250	250	250	250	250	250
Travel Limit (+)	52	100	0	0	0	0
Travel Limit (-)	0	0	-11	0	0	0
x1 Linear Jog Increment <i>inches</i>	0.001					
x1 Rotary Jog Increment <i>degrees</i>	0.1					

2.) Plasma CNC12 software with Centroid Torch Height Controller (THC) hardware support is now available for use with the AcornSix and Hickory CNC controllers.

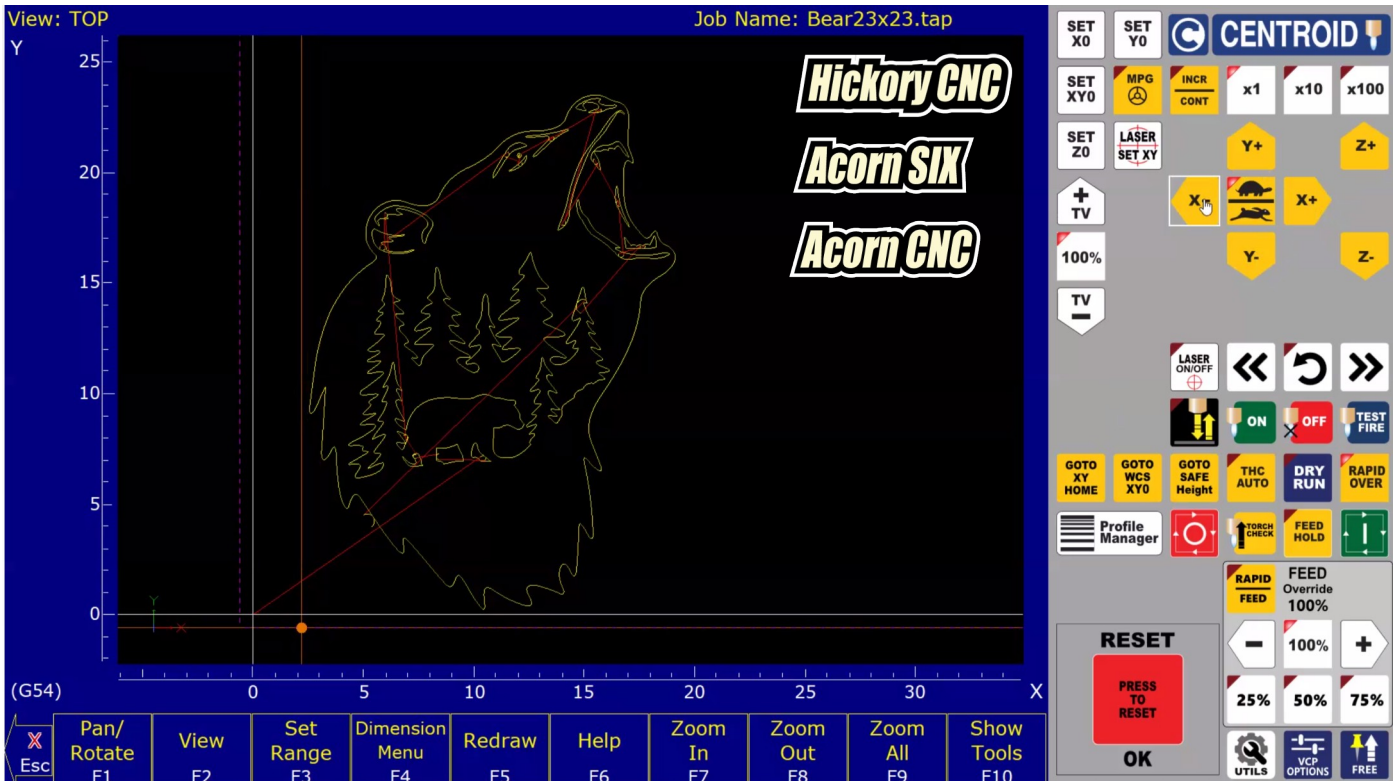

Now you can control a CNC Plasma Machine with the AcornSix or Hickory CNC Controllers in addition to the Acorn controller.



<https://shopcentroidcnc.com/acornsix-cnc-controller/>

<https://shopcentroidcnc.com/hickory-cnc-controller/>

3.) USB-BOB support in CNC12 and the Wizard (Acorn, AcornSix and Hickory) . Create your own CNC control operators console with the USB-BOB!

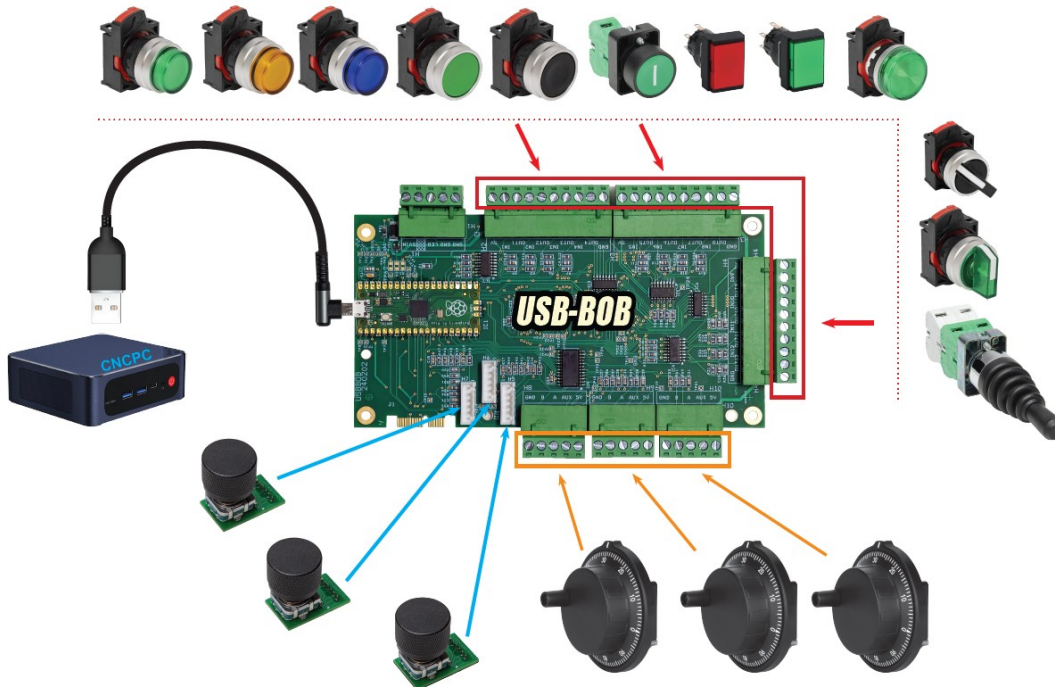

Router CNC Control Configuration Wizard

### Centroid USB-BOB CNC Operator Control Panel Breakout Board

**Input Type**

- FeedHold
- FeedRate 100%
- FeedRate 25%
- FeedRate 50%
- FeedRate 75%
- Flood
- JogDisable
- Limit Defeat
- Mist
- MPG Axis 4 Select
- MPG Mode Toggle
- PopUpPins
- RapidFeedLink
- RapidRate 100%
- RapidRate 25%
- RapidRate 50%
- RapidRate 75%
- SingleBlock
- Spindle Brake
- Spindle Range High
- Spindle Range Low
- Spindle Range Med
- Spindle Speed 100%
- Spindle Speed Minus
- Spindle Speed Plus

✔ USB-BOB #1 Connected
✘ USB-BOB #2 Not Found

Input Definition	
1 IN1	CycleStart
2 IN2	ToolCheck
3 IN3	CycleCancel
4 IN4	Spindle Auto/Manual
5 IN5	Spindle On Toggle
6 IN6	Spindle CW
7 IN7	Spindle CCW
8 IN8	Incremental/Continuous Jog
9 IN9	MPG Axis 1 Select
10 IN10	MPG Axis 2 Select
11 IN11	MPG Axis 3 Select
12 IN12	ToolRelease
13 KB13	Feedrate Custom %
14 KB14	Spindle Speed Custom %
15 KB15	Rapidrate Custom %

MPG (H8)      MPG (H9)      MPG (H10)

Use Selector Switch    Select Axis    Select Axis

**Override Encoder Knob Speed Multiplier 1x-20x**

Feedrate Override (H5)    1 x

Spindle Speed Override (H6)    1 x

Rapid Override (H7)    1 x

**Values for the Encoder Knob Push Button when using the "Custom" % inputs**

Value for use with the "Feedrate Custom %" input    2 %

Value for use with the "Spindle Speed Custom %" input    100 %

Value for use with the "Rapidrate Custom %" input    50 %

Connected to CNC12

Write Settings to CNC Control Configuration

More information on USB-BOB is here: [https://shopcentroidcnc.com/shop/cnc-accessories/centroid\\_usb-bob\\_operator\\_control\\_panel/](https://shopcentroidcnc.com/shop/cnc-accessories/centroid_usb-bob_operator_control_panel/)

4.) New CNC12 Router specific CNC12 software for Acorn, AcornSix and Hickory!

- CNC12 Function Key tree rearranged for improved Router Work Flow (less keystrokes, and new tree puts the menus you use the most often at your finger tips)

WCS #1 (G54) Current Position (Inches)

Job Name: NO\_JOB\_LOADED.cnc  
 Tool: T1 H1  
 Feedrate: 100% 0.0 ipm  
 Spindle: 0 A  
 Rapid Rate: 100%

335 Emergency stop released  
 347 Reset Cleared  
 490 Reset Initiated, Press Reset to Clear  
 347 Reset Cleared

Press CYCLE START to start job

--- Warning: Machine Home Position Not Set ---

1) Jog all axes to Machine Home Position  
 2) Press CYCLE START to set the home position

Machine Coord.  
 X +0.0000  
 Y +0.0000  
 Z +0.0000

MPU12 SYSTEM ID  
 38D2694D64EF-0406180825  
 CNC12 Acorn Router v5.20  
 ACORN ROUTER PRO

Buttons: Set Part Zeros (F1), Load Job (F2), MDI (F3), Tool/ATC (F5), Edit G-code (F6), Utility Menu (F7), Smoothing (F9), Shut Down Menu (F10)

- All new Router Part Setup Menu with menu driven support for Part Setups for all common Router specific methods such as but not limited to: Touch Plate, Cross Hair Laser, Touch Probe, and various Manual methods all in one quick to navigate menu. Here are a few samples of the new part setup menus.

WCS #1 (G54) Current Position (Inches)

Job Name: NO\_JOB\_LOADED.cnc  
 Tool: T1 H1  
 Feedrate: 100% 0.0 ipm  
 Spindle: 0 A  
 Rapid Rate: 100%

335 Emergency stop released  
 347 Reset Cleared  
 490 Reset Initiated, Press Reset to Clear  
 347 Reset Cleared

Press CYCLE START to start job

Distance to Go  
 X +0.0000  
 Y +0.0000  
 Z +0.0000

Machine Coord.  
 X +0.0000  
 Y +0.0000  
 Z +0.0000

Buttons: Set Part Zeros (F1), Load Job (F2), MDI (F3), Run Job Options (F4), Tool/ATC (F5), Edit G-code (F6), Utility Menu (F7), Graph Job (F8), Smoothing (F9), Shut Down Menu (F10)

A few select Router Part Setup Menu Screen Shots

WCS #1 (G54) Current Position (Inches) Job Name: Non ATC Gasket Groove.cnc

X +1.2400 Tool: T2 H---  
 Y +0.7900 Feedrate: 100% 0.0 ipm  
 Z -0.1569 Spindle: 0 A  
 Rapid Rate: 100%

335 Emergency stop released  
 347 Reset Cleared  
 490 Reset Initiated, Press Reset to Clear  
 347 Reset Cleared

Press CYCLE START to start job

Touch Plate XYZ Position Auto Probing  
 1.) Position Tool, adjust options  
 2.) Press Cycle Start to run the Probing Cycle

Bit Diameter 1.0000 Magnet Reminder Yes  
 Z Clearance Amount 1.0000 Flute Reminder Yes  
 Return Z to home Yes Set Z Zero Yes

F2 to Select Corner

Esc	Inside/Outside F1	Corner F2	Side F3	Z Only F5	Bore F6	Set CSR Angle F7	Plate Setup F8	WCS CSR Table F9
-----	-------------------	-----------	---------	-----------	---------	------------------	----------------	------------------

RIGHT PANEL: AUTO SPINDLE MAN, SET WCS XY, SET WCS Z0, Auto Z to PLATE, PARK, SET Rotary WCS, M55, GOTO WCS XY, LIMIT SWITCH DEFEAT, M58, LASER SET XY, LASER ON/OFF, RESET HOME, AUTO MAN, DUST Collector, Hold Down VAC, Air Blow, Change TOOL, INCR CONT, x1, x10, x100, MPG, 4th+, Y+, Z+, X-, X+, Y-, Z-, SINGLE BLOCK, TOOL CHECK, FEED HOLD, RAPID FEED, FEED Override 100%, 25%, 50%, 75%, RESET, PRESS TO RESET, OK, UTILS, VCP OPTIONS, FREE.

Avid CNC Touch Plate Part Zero setup menu.

WCS #1 (G54) Current Position (Inches) Job Name: Non ATC Gasket Groove.cnc

X +0.0000 Tool: T2 H---  
 Y +0.0000 Feedrate: 100% 0.0 ipm  
 Z +0.0000 Spindle: 0 A  
 Rapid Rate: 100%

335 Emergency stop released  
 347 Reset Cleared  
 490 Reset Initiated, Press Reset to Clear  
 347 Reset Cleared

Press CYCLE START to start job

Touch Plate XYZ Position Auto Probing  
 1.) Position Tool, adjust options  
 2.) Press Cycle Start to run the Probing Cycle

Bit Diameter 1.0000 Magnet Reminder Yes  
 Z Clearance Amount 1.0000 Flute Reminder Yes  
 Return Z to home Yes Set Z Zero Yes

F2 to Select Corner

Esc	Inside/Outside F1	Corner F2	Side F3	Z Only F5	Bore F6	Set CSR Angle F7	Plate Setup F8	WCS CSR Table F9
-----	-------------------	-----------	---------	-----------	---------	------------------	----------------	------------------

RIGHT PANEL: AUTO SPINDLE MAN, SET WCS XY, SET WCS Z0, Auto Z to PLATE, PARK, SET Rotary WCS, M55, GOTO WCS XY, LIMIT SWITCH DEFEAT, M58, LASER SET XY, LASER ON/OFF, RESET HOME, AUTO MAN, DUST Collector, Hold Down VAC, Air Blow, Change TOOL, INCR CONT, x1, x10, x100, MPG, 4th+, Y+, Z+, X-, X+, Y-, Z-, SINGLE BLOCK, TOOL CHECK, FEED HOLD, RAPID FEED, FEED Override 100%, 25%, 50%, 75%, RESET, PRESS TO RESET, OK, UTILS, VCP OPTIONS, FREE.

Touch Plate menus

WCS #1 (G54) Current Position (Inches) Job Name: Non ATC Gasket Groove.cnc  
 Tool: T2 H--- Feedrate: 100% 0.0 ipm Spindle: 0 A Rapid Rate: 100%

X +1.2400  
 Y +0.7900  
 Z -0.1569

335 Emergency stop released  
 347 Reset Cleared  
 490 Reset Initiated, Press Reset to Clear  
 347 Reset Cleared  
 Press CYCLE START to start job

Cross Hair LASER Set Part Zero Location  
 Jog to position, enter values press F10 Set

Axis	Part Position
X	0.0000
Y	0.0000

X Laser to Spindle C/L Offset -4.0000  
 Y Laser to Spindle C/L Offset 1.5000

Manual F1 Laser F2 Probe F3 Plate F4 CSR F5 Laser On F7 Teach Offset F8 WCS CSR Table F9 Set F10

ACORN CNC Control Panel:  
 + AUTO SPINDLE MAN, 100%, M3, SET WCS XY, SET WCS Z0, Auto Z to PLATE, PARK, M4, SET Rotary WCS, M55, GOTO WCS XY, LIMIT SWITCH DEFEAT, M58, LASER SET XY, LASER ON/OFF, RESET HOME, AUTO MAN, DUST Collector, Hold Down VAC, Air Blow, Change TOOL, INCR CONT, x1, x10, x100, MPG, 4th+, 4th-, SINGLE BLOCK, TOOL CHECK, FEED HOLD, RAPID FEED, FEED Override 100%, 25%, 50%, 75%, RESET, PRESS TO RESET, OK, UTILS, VCP OPTIONS, FREE

Cross Hair Laser to set X and Y zero position

WCS #1 (G54) Current Position (Inches) Job Name: Non ATC Gasket Groove.cnc  
 Tool: T2 H--- Feedrate: 100% 0.0 ipm Spindle: 0 A Rapid Rate: 100%

X +1.2400  
 Y +0.7900  
 Z -0.1569

335 Emergency stop released  
 347 Reset Cleared  
 490 Reset Initiated, Press Reset to Clear  
 347 Reset Cleared  
 Press CYCLE START to start job

Set Part Zero Position

Axis	Part Position	Edge Finder Dia.	Approach from
X	0.0000	0.2500	Left (-)
Y	0.0000	0.2500	Back (+)
Z	0.0000	Tool #: 2	

Help: Shift F12

Manual F1 Laser F2 Probe F3 Plate F4 CSR F5 Auto Zero F7 Set XY F8 WCS CSR Table F9 Set F10

ACORN CNC Control Panel:  
 + AUTO SPINDLE MAN, 100%, M3, SET WCS XY, SET WCS Z0, Auto Z to PLATE, PARK, M4, SET Rotary WCS, M55, GOTO WCS XY, LIMIT SWITCH DEFEAT, M58, LASER SET XY, LASER ON/OFF, RESET HOME, AUTO MAN, DUST Collector, Hold Down VAC, Air Blow, Change TOOL, INCR CONT, x1, x10, x100, MPG, 4th+, 4th-, SINGLE BLOCK, TOOL CHECK, FEED HOLD, RAPID FEED, FEED Override 100%, 25%, 50%, 75%, RESET, PRESS TO RESET, OK, UTILS, VCP OPTIONS, FREE

Manually touch part edge and set X zero position

WCS #1 (G54) Current Position (Inches) Job Name: Non ATC Gasket Groove.cnc  
 X +1.2400 Tool: T2 H--- Feedrate: 100% 0.0 ipm  
 Y +0.7900 Spindle: 0 A Rapid Rate: 100%  
 Z -0.1569

335 Emergency stop released  
 347 Reset Cleared  
 490 Reset Initiated, Press Reset to Clear  
 347 Reset Cleared  
 Press CYCLE START to start job

Set Part Zero Position

Axis	Part Position	Edge Finder Dia.	Approach from
X	0.0000	0.2500	Left (-)
Y	0.0000	0.2500	Back (+)
Z	.75	Tool #: 2	

Help: Shift F12

Manual Laser Probe Plate CSR Auto Zero Set XY WCS CSR Set  
 Esc F1 F2 F3 F4 F5 F7 F8 F9 F10

Acorn CNC  
 AUTO SPINDLE MAN  
 100% M3 SET WCS XY0 Auto Z to PLATE PARK  
 M4 SET Rotary WCS M55 GOTO WCS XY0 LIMIT SWITCH DEFEAT  
 M58 LASER SET XY LASER ON/OFF RESET HOME  
 AUTO MAN DUST Collector Hold Down VAC Air Blow  
 Change TOOL INCR CONT x1 x10 x100 MPG  
 4th+ 4th- 4th- SINGLE BLOCK TOOL CHECK FEED HOLD  
 RAPID FEED FEED Override 100%  
 25% 50% 75%  
 RESET PRESS TO RESET OK  
 UTILS VCP OPTIONS FREE

Manually set Z part zero position

WCS #1 (G54) Current Position (Inches) Job Name: Non ATC Gasket Groove.cnc  
 X +1.2400 Tool: T2 H--- Feedrate: 100% 0.0 ipm  
 Y +0.7900 Spindle: 0 A Rapid Rate: 100%  
 Z -0.1569

335 Emergency stop released  
 347 Reset Cleared  
 490 Reset Initiated, Press Reset to Clear  
 347 Reset Cleared  
 Press CYCLE START to start job

Set Part Zero Position

Axis	Part Position	Edge Finder Dia.	Approach from
X	0.0000	0.2500	Left (-)
Y	0.0000	0.2500	Center
Z	0.7500	Tool #: 10	

Help: Shift F12

Manual Laser Probe Plate CSR Auto Zero Set XY WCS CSR Set  
 Esc F1 F2 F3 F4 F5 F7 F8 F9 F10

Acorn CNC  
 AUTO SPINDLE MAN  
 100% M3 SET WCS XY0 Auto Z to PLATE PARK  
 M4 SET Rotary WCS M55 GOTO WCS XY0 LIMIT SWITCH DEFEAT  
 M58 LASER SET XY LASER ON/OFF RESET HOME  
 AUTO MAN DUST Collector Hold Down VAC Air Blow  
 Change TOOL INCR CONT x1 x10 x100 MPG  
 4th+ 4th- 4th- SINGLE BLOCK TOOL CHECK FEED HOLD  
 RAPID FEED FEED Override 100%  
 25% 50% 75%  
 RESET PRESS TO RESET OK  
 UTILS VCP OPTIONS FREE

Set Part Edge X0 with Touch Probe

WCS #1 (G54) Current Position (Inches) Job Name: Non ATC Gasket Groove.cnc  
 X +1.5731 Tool: T2 H--- Feedrate: 100% 0.0 ipm  
 Y +1.0900 Spindle: 0 A Rapid Rate: 100%  
 Z -0.1569

335 Emergency stop released  
 347 Reset Cleared  
 490 Reset Initiated, Press Reset to Clear  
 347 Reset Cleared  
 Press CYCLE START to start job

Manual CSR Coordinate System Rotation

3.) Jog to SECOND position  
 4.) Press F10 to accept SECOND position

Measured CSR Angle 0.0000  
 Last Probed CSR Angle 0.0000

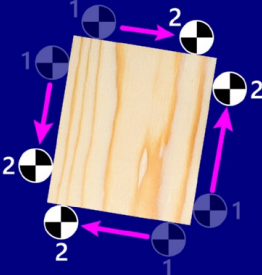

Manual Teach CSR F2	Laser Teach CSR F3	Probe CSR F4	Touch Plate CSR F5	Probe Cycles F6	Zero CSR F7	MDI F8	WCS CSR Table F9	Accept F10
---------------------	--------------------	--------------	--------------------	-----------------	-------------	--------	------------------	------------

RESET  
 PRESS TO RESET  
 OK

UTILS VCP OPTIONS FREE

Manual "jog to position to set Coordinate System Rotation (CSR)"

WCS #1 (G54) Current Position (Inches) Job Name: Non ATC Gasket Groove.cnc  
 X +1.5731 Tool: T2 H--- Feedrate: 100% 0.0 ipm  
 Y +1.0900 Spindle: 0 A Rapid Rate: 100%  
 Z -0.1569

335 Emergency stop released  
 347 Reset Cleared  
 490 Reset Initiated, Press Reset to Clear  
 347 Reset Cleared  
 Press CYCLE START to start job

Laser Coordinate System Rotation

3.) Jog Cross Hair Laser to SECOND position  
 4.) Press F10 to set SECOND position

Measured CSR Angle 0.0000  
 Last Probed CSR Angle 0.0000

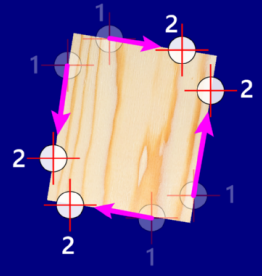

Laser On F1	Manual Teach CSR F2	Laser Teach CSR F3	Probe CSR F4	Touch Plate CSR F5	Probe Cycles F6	Zero CSR F7	MDI F8	WCS CSR Table F9	Accept F10
-------------	---------------------	--------------------	--------------	--------------------	-----------------	-------------	--------	------------------	------------

RESET  
 PRESS TO RESET  
 OK

UTILS VCP OPTIONS FREE

Cross Hair Laser set Coordinate System Rotation (CSR)

WCS #1 (G54) **Current Position (Inches)** Job Name: NO\_JOB\_LOADED.cnc  
**X** +1.5731 Tool: T2 H---  
**Y** +1.0900 Feedrate: 100% 0.0 ipm  
**Z** -0.1569 Spindle: 0 A  
Rapid Rate: 100%

335 Emergency stop released  
347 Reset Cleared  
490 Reset Initiated, Press Reset to Clear  
347 Reset Cleared

Press CYCLE START to start job

Probing Cycles (Upgrade to Pro for all Probing Cycles)

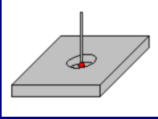
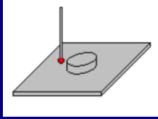
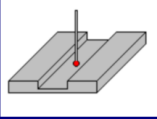
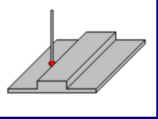
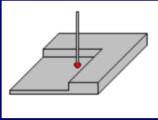
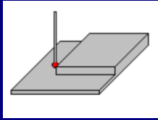
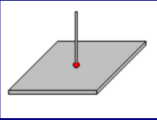
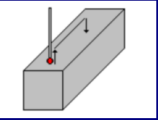
 Bore	 Boss	 Slot	 Web
 Inside Corner	 Outside Corner	 Single Axis	 Find Angle

Probe diameter (Tool #10): 0.2500 Record Probing Data (.\\probe\_cycles\_history.txt) On

Esc Bore F1 Probe Setup F9 Stylus Calibration F10

**ACORN CNC** Control Panel:

- AUTO SPINDLE MAN
- 100%
- M3
- M4
- SET WCS XYO
- SET WCS ZO
- Auto Z to PLATE
- PARK
- SET Rotary WCS
- M55
- GOTO WCS XYO
- LIMIT SWITCH DEFEAT
- M58
- LASER SET XY
- LASER ON/OFF
- RESET HOME
- AUTO MAN
- DUST Collector
- Hold Down VAC
- Air Blow
- Change TOOL
- INCR CONT
- x1
- x10
- x100
- MPG
- 4th+
- Y+
- Z+
- X-
- Y-
- X+
- Z-
- 4th-
- SINGLE BLOCK
- TOOL CHECK
- FEED HOLD
- RAPID FEED
- FEED Override 100%
- RESET
- PRESS TO RESET
- OK
- UTILS
- VCP OPTIONS
- FREE

Touch Probe Menu, find positions, set part zeros, calibrate probe pre-travel automatically, record probed data to a text file.

- Router Touch Plate setup menus added to the Router Wizard, Preset AvidCNC Touch Plate selection along with "Define your own Touch Plate Geometry" for simple touch plate setup.

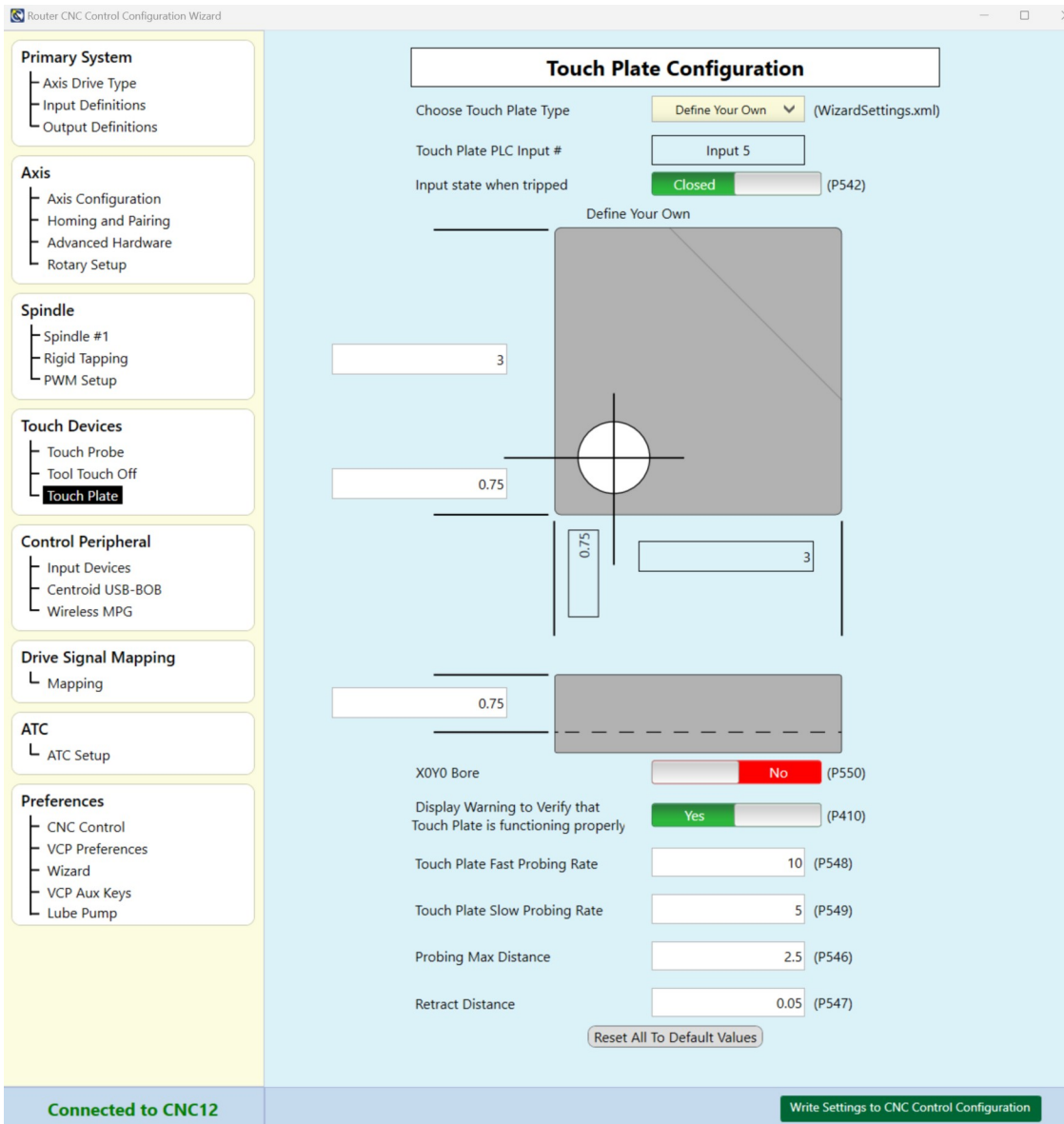

Define your own Touch Plate geometry, with or without a bore.

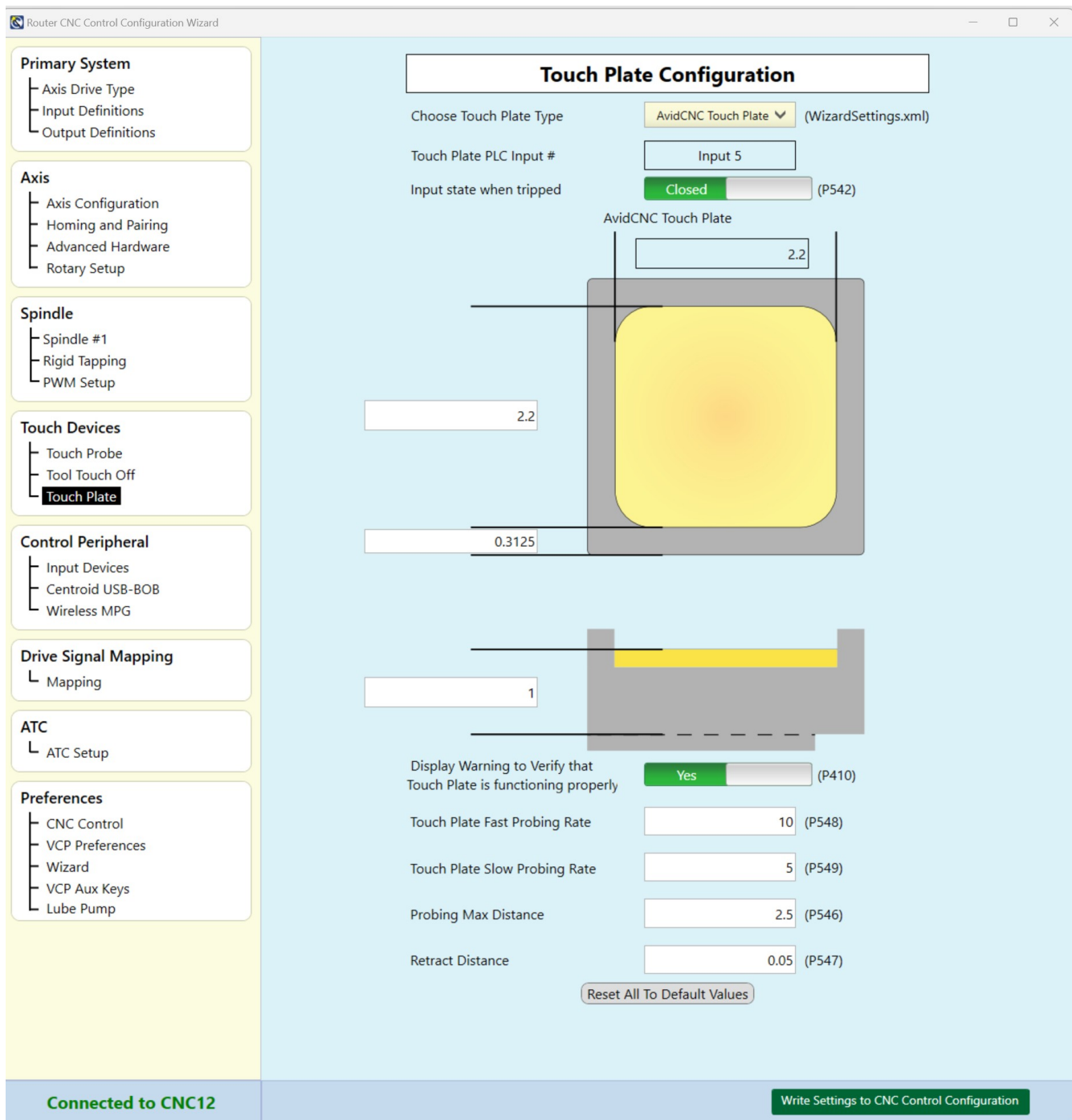

Avid CNC Touch Plate is pre-filled in with the correct data, just select it and press “Write Settings to CNC control configuration”

Router CNC Control Configuration Wizard

**Primary System**

- └ Axis Drive Type
- └ Input Definitions
- └ Output Definitions

**Axis**

- └ Axis Configuration
- └ Homing and Pairing
- └ Advanced Hardware
- └ Rotary Setup

**Spindle**

- └ Spindle #1
- └ Rigid Tapping
- └ PWM Setup

**Touch Devices**

- └ Touch Probe
- └ Tool Touch Off
- └ **Touch Plate**

**Control Peripheral**

- └ Input Devices
- └ Centroid USB-BOB
- └ Wireless MPG

**Drive Signal Mapping**

- └ Mapping

**ATC**

- └ ATC Setup

**Preferences**

- └ CNC Control
- └ VCP Preferences
- └ Wizard
- └ VCP Aux Keys
- └ Lube Pump

### Touch Plate Configuration

Choose Touch Plate Type Surface Plate (WizardSettings.xml)

Touch Plate PLC Input # Input 5

Input state when tripped Closed (P542)

Surface Plate

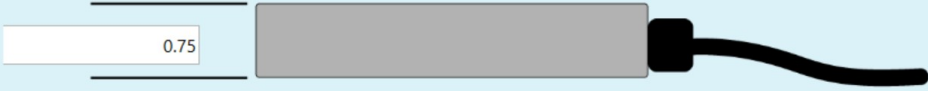

Display Warning to Verify that Touch Plate is functioning properly Yes (P410)

Touch Plate Fast Probing Rate 10 (P548)

Touch Plate Slow Probing Rate 5 (P549)

Probing Max Distance 2.5 (P546)

Retract Distance 0.05 (P547)

[Reset All To Default Values](#)

Connected to CNC12
Write Settings to CNC Control Configuration

and for those using a simple piece of metal as a touch off to set part Z zeros rather than a XYZ touch plate.

5.) The Hickory CNC controller now supports Clearpath EC EtherCat servo motors.  
Link to the Centroid Hickory Clearpath setup Tech Bulletin:  
[https://www.centroidcnc.com/dealersupport/tech\\_bulletins/uploads/332.pdf](https://www.centroidcnc.com/dealersupport/tech_bulletins/uploads/332.pdf)

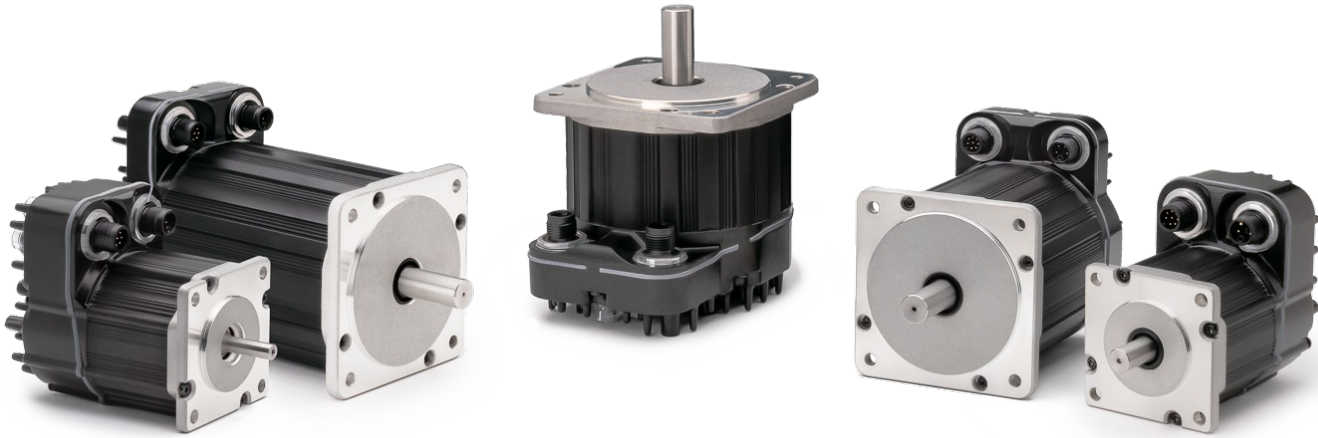

Link to Teknic web page.  
<https://teknic.com/products/clearpath-brushless-dc-servo-motors/ethercat-servo/>

6.) Useful new G-code backplot features such as Travel Limit, Work Envelope, Dynamic Spindle Position indicator, WCS position. Example below shows the G code job exceeding the machine travel limits with the current Part zero location. Available in Mill, Router and Plasma. (Lathe will get these new features in the next version release)

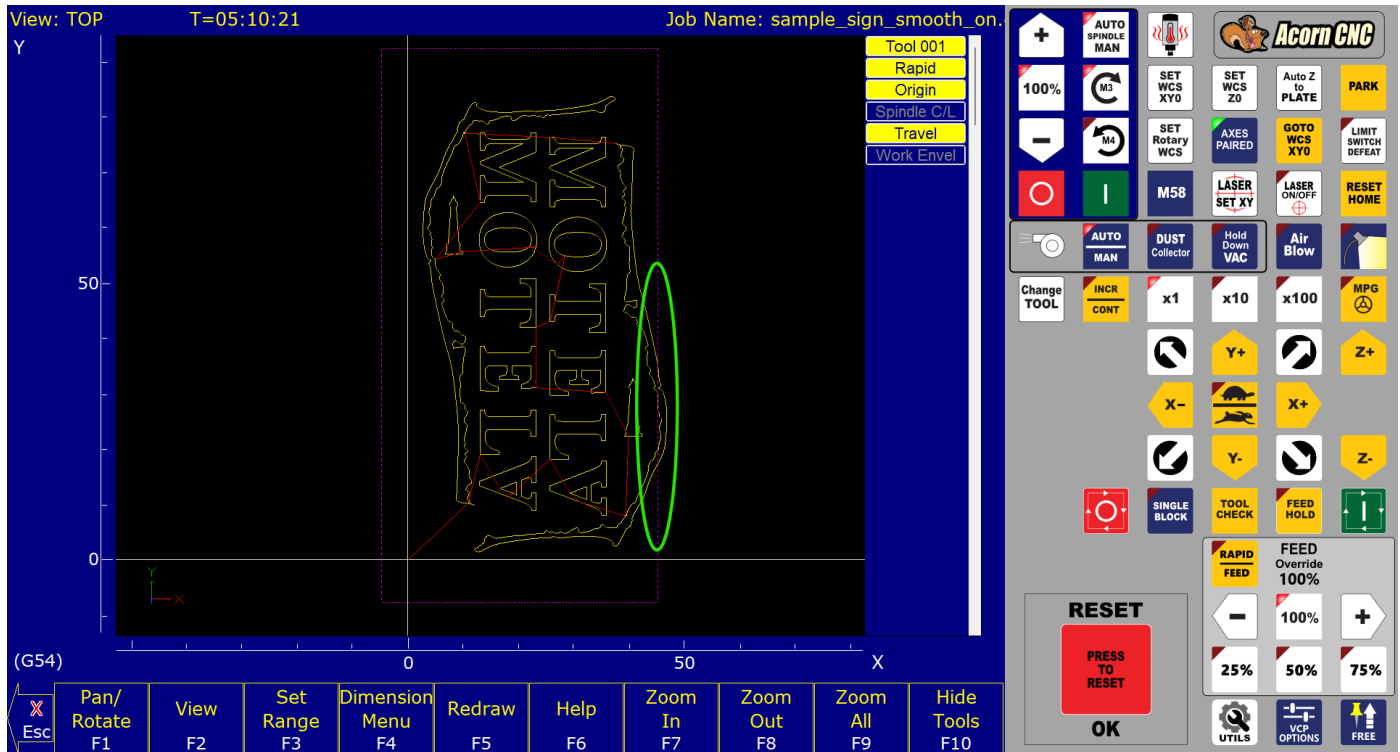

Video demonstration is here [https://youtu.be/dhe\\_YG7Fsc4](https://youtu.be/dhe_YG7Fsc4)

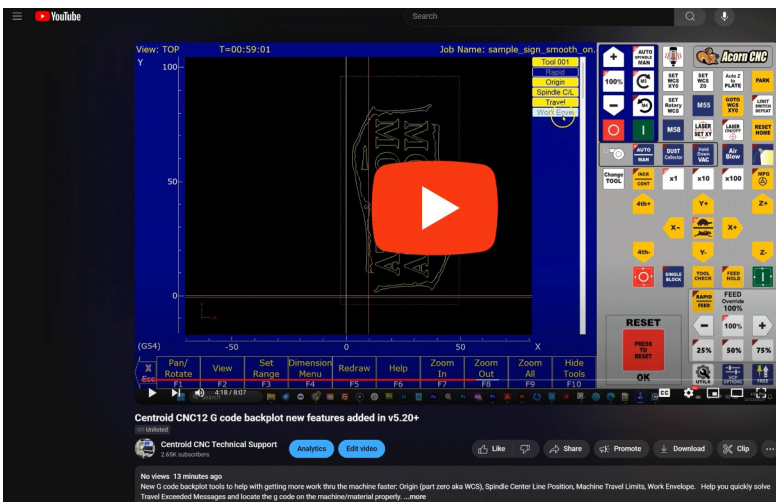

7.) Hardware Pairing with Autosquaring is now a “canned” feature and has been added to the Acorn and AcornSix Wizard. Now you can hardware pair an axis (two axis motors hardwired together on one axis, typically a gantry) and the Wizard will write the homing program for you that will home and auto square a hardware paired axis! (no custom code needed but, you can still customize it if you want.)

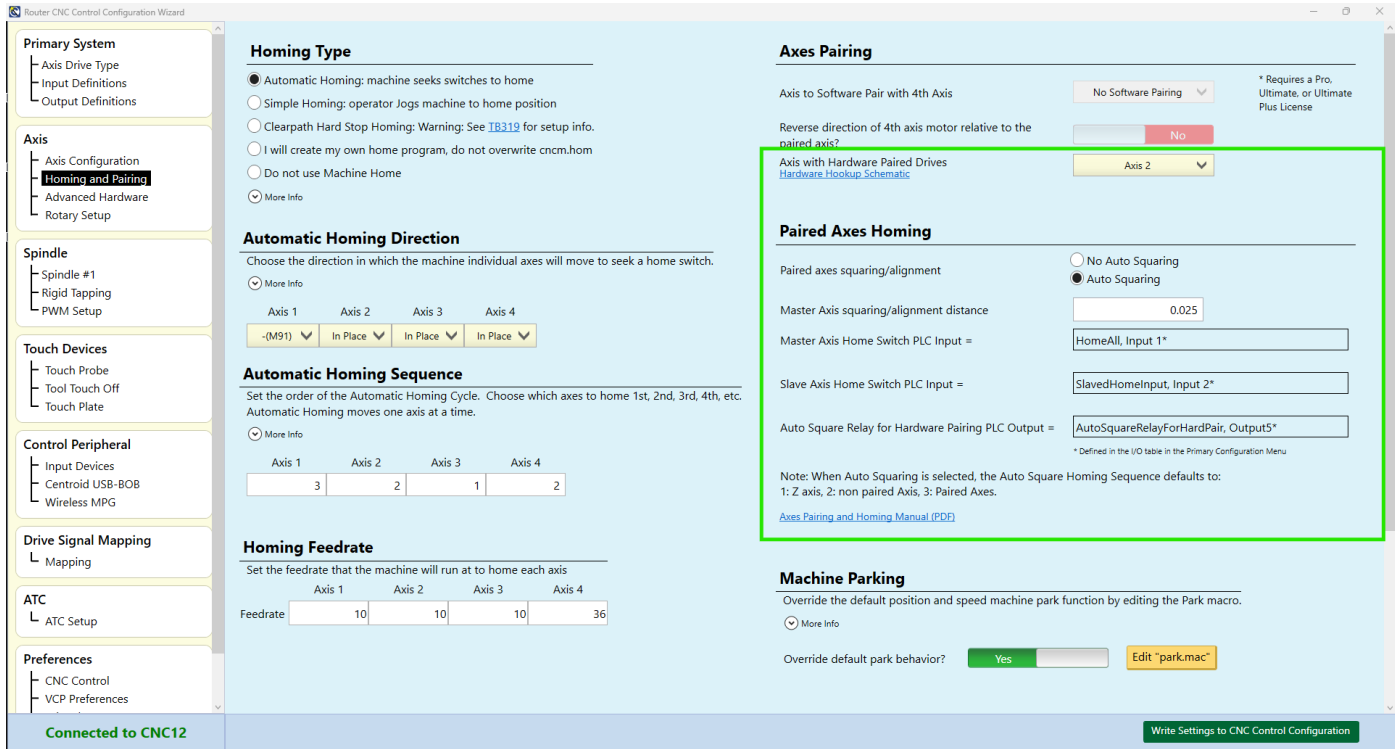

Link to typical Hardware Paired CNC Router Gantry machine schematic with Autosquaring. (S15200)

[https://www.centroidcnc.com/centroid\\_diy/schematics/pbrowse.php?term=hardware](https://www.centroidcnc.com/centroid_diy/schematics/pbrowse.php?term=hardware)

8.) Lathe: G64 smoothing added to Lathe CNC12 (was previously only available in Mill, Router and Plasma).

**Smoothing Setup Menu**

Smoothing on/off:	<input type="checkbox"/> OFF <input checked="" type="checkbox"/> ON		Smoothing is ON (P220) *
Slower Curves	<input type="range"/>	Faster Curves	Curve Feedrate Multiplier at 100% (P230)
Round All	<input type="range"/>	Sharpen All	Angles up to 95 degrees will be sharpened (P227)
Gentler Stops	<input type="range"/>	Faster Stops	Acceleration Multiplier at 100% (P231)

**Quick Setups**  
\* F2 Precision Lathe is selected

X Esc	Exact Stop F1	Precision Lathe F2	Contouring Lathe F3		Customize Presets F9	Save F10
----------	---------------------	--------------------------	---------------------------	--	----------------------------	-------------

Uwe Mattern made a video showing his unique way of using G64 on a Lathe Part.  
<https://youtu.be/HNRWMMaluq4?si=IFqPM2RwDXPVJ3tu>

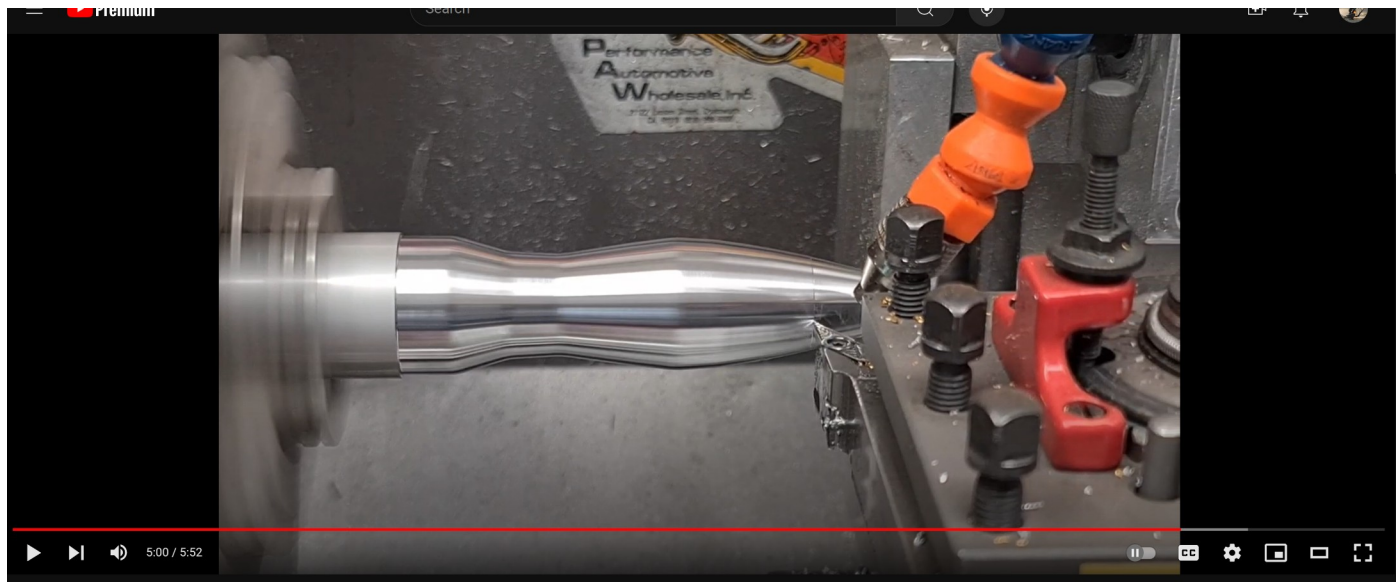

9.) Lathe: Spindle Speed Variation and Feedrate Speed Variation is now a standard feature of Mill, Lathe , Router versions of CNC12. SSV and FRV are most useful for Lathe applications. Setup SSV and FRV parameters in the Wizard or via CNC12 Parameters.

Simple M code to turn either feature on and off.

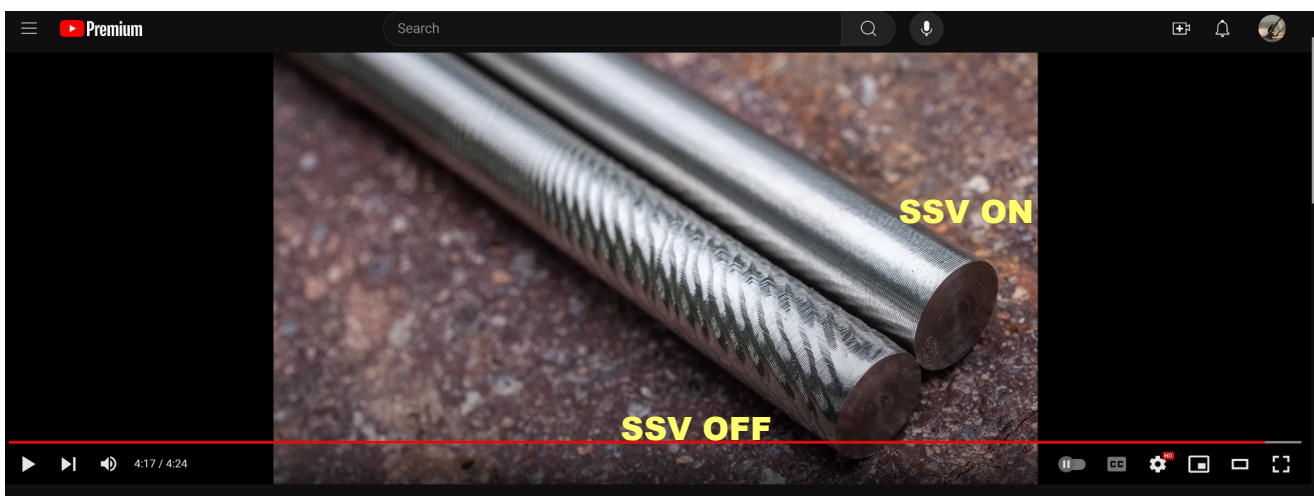
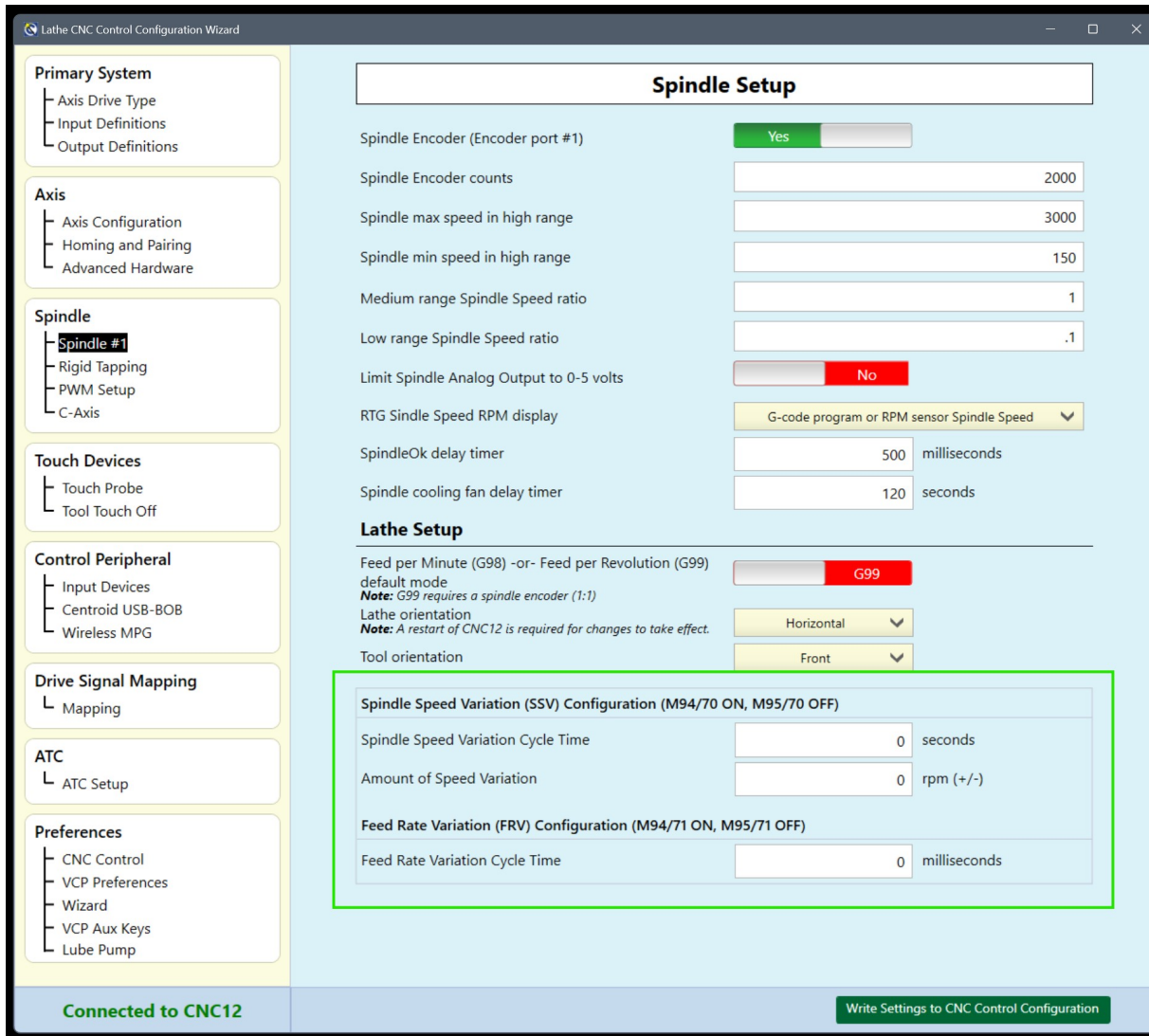

Video showing SSV OFF vs. SSV ON <https://youtu.be/o6YsrY0MDoA>

10.) CNC12 On screen text/words/labels/language file editing improvements.

Users can always change any words in CNC12 by simply editing the Centroid provided language.msg text file. What's new is now you can leave the Centroid provided language.msg text file ( the default file included with the CNC12 installation) alone and create a 'modifier' file called "user\_language.msg" this modifier file overrides the default file with just the changes you want.

The main advantage of this method is that it allows the user/oem to modify CNC12 words by creating a user language file that contains just the changes they want and easily copy those changes to a new installation of CNC12 without have to edit/re edit the Centroid default file, this allows Centroid to continue to make improvements and additions to the CNC12 language file with each new version while the user/oem can continue to use/reuse their same file with their custom changes with any new versions of CNC12. This new user language file makes modifying the words on CNC12 more convenient by saving time when installing multiple CNC12 installations and 'upgrading' to a new version of CNC12.

Any text present in CNC12 can be changed with the new file. For example, using the new Router version of CNC12, if we wanted to change the Function Key F2 words "Load Job" to "Open File"

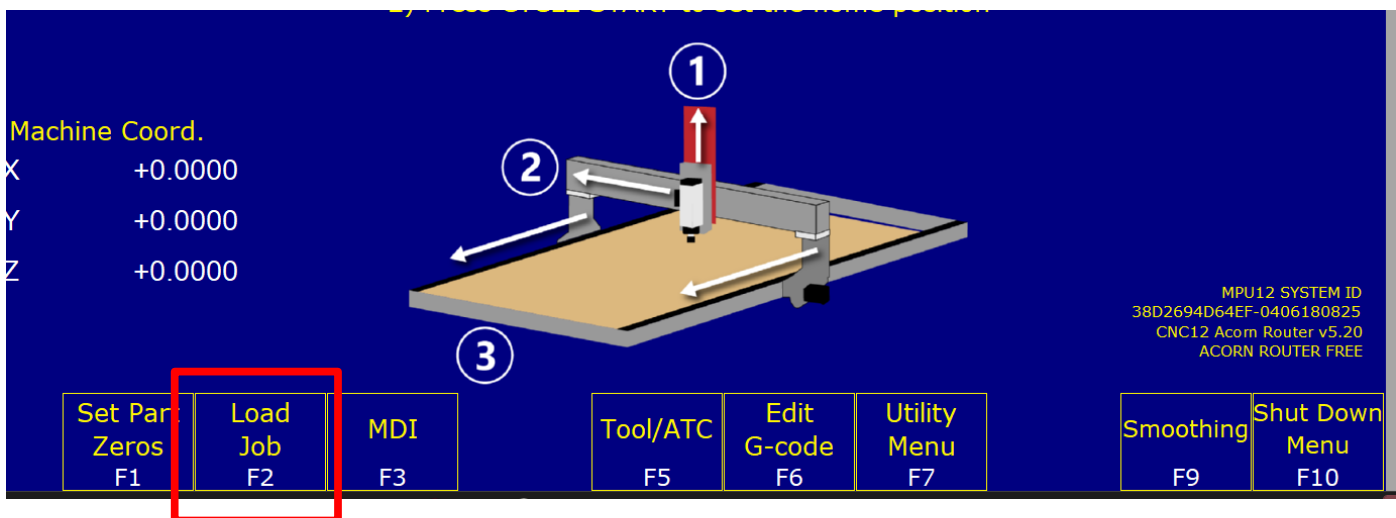

a.) Open Notepad ++ and create a new file. " user\_language.msg " and save it in the root CNC12 directory ( cncm or cnct etc)

b.) Open the stock c:\cncm\language.msg file

Use the search feature of Notepad ++ find the words you want to change.

In this case I searched on @LOAD\_BUTTON

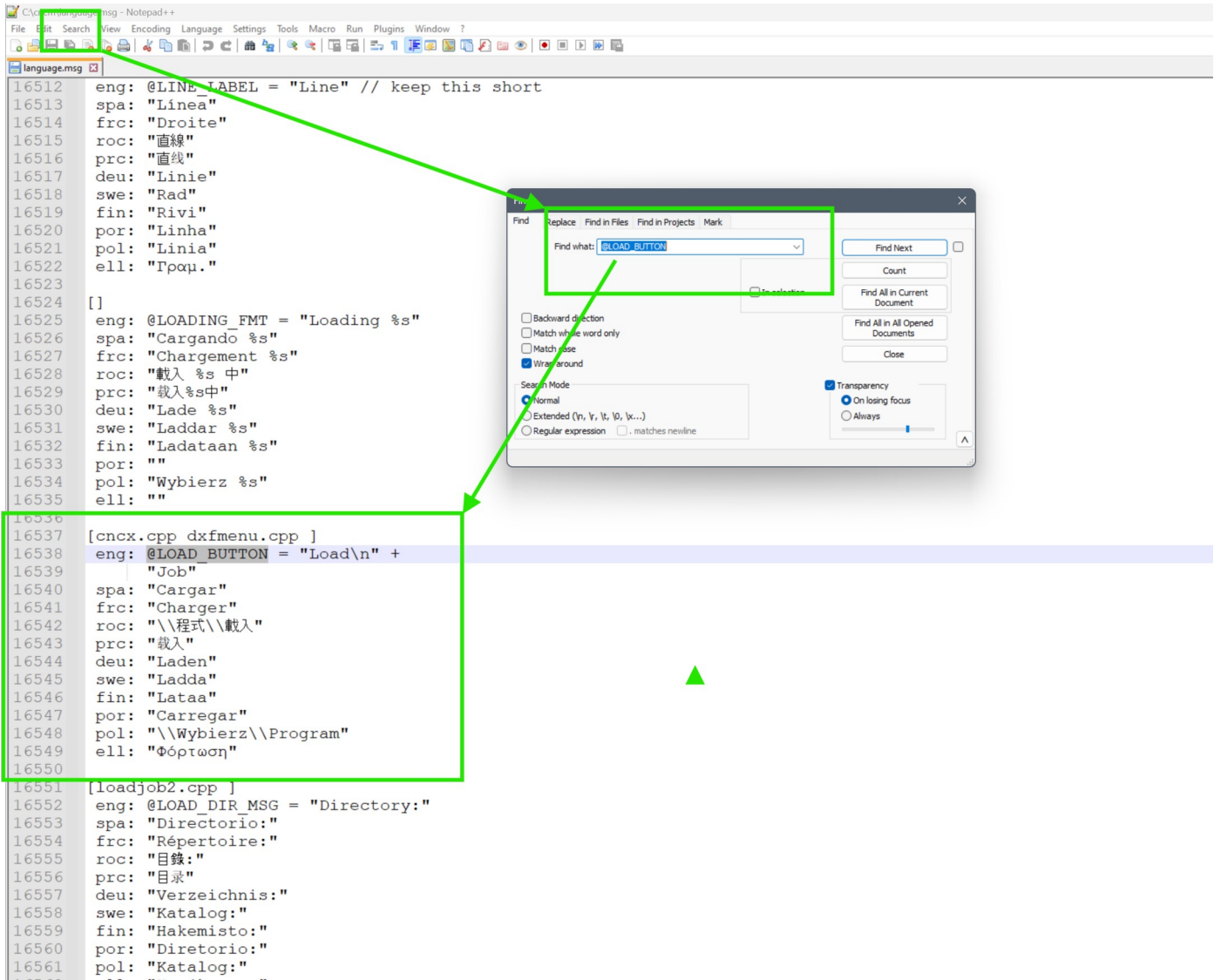

c.) The format for the user\_language.msg file is the same as that of default Centroid language.msg file with the additional field of 'replacement:'.

Copy the entire Load Button section of the default Centroid language.msg file and paste it into the new user\_language.msg file, below is the Load Button section that I copied into the new user\_language.msg file

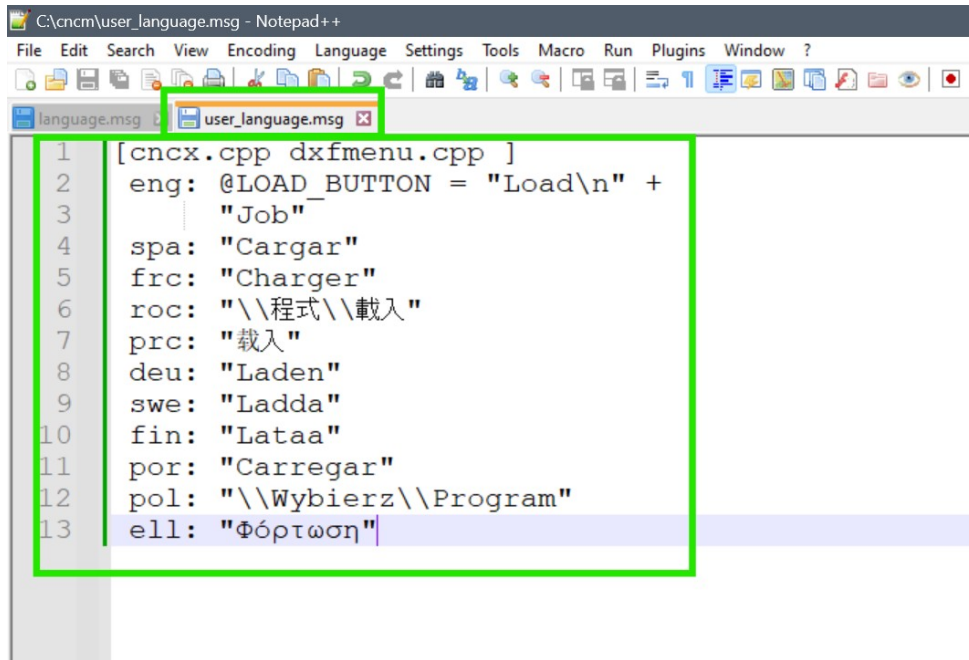

```
C:\cncm\user_language.msg - Notepad++
File Edit Search View Encoding Language Settings Tools Macro Run Plugins Window ?
language.msg user_language.msg
1 [cncx.cpp dxfmenu.cpp ]
2 eng: @LOAD_BUTTON = "Load\n" +
3     "Job"
4 spa: "Cargar"
5 frc: "Charger"
6 roc: "\\程式\\載入"
7 prc: "載入"
8 deu: "Laden"
9 swe: "Ladda"
10 fin: "Lataa"
11 por: "Carregar"
12 pol: "\\Wybierz\\Program"
13 ell: "Φόρτωση"
```

```
[cncx.cpp dxfmenu.cpp ]
eng: @LOAD_BUTTON = "Load\n" +
    "Job"
spa: "Cargar"
frc: "Charger"
roc: "\\程式\\載入"
prc: "載入"
deu: "Laden"
swe: "Ladda"
fin: "Lataa"
por: "Carregar"
pol: "\\Wybierz\\Program"
ell: "Φόρτωση"
```

d.) In the user\_language.msg file echo what you want to replace in this section by adding the "replacement:" line directly under the header. Highlighted in orange

```
[cncx.cpp dxfmenu.cpp ]
replacement: "Load\n" +
    "Job"
eng: @LOAD_BUTTON = "Load\n" +
    "Job"
spa: "Cargar"
frc: "Charger"
.....
```

The replacement line we just added in orange above tells CNC12 that you want to replace the words Load Job "Load\n" + "Job"

Now edit the words in the Load Button section of the user\_language.msg file that you want to change.

In this example, the English words for the F2 Load Job Function key are changed from “Load Job” to “Open File” on the eng: line highlighted in yellow below

```
[cncx.cpp dxfmnu.cpp ]  
replacement: "Load\n" +  
  "Job"  
eng: @LOAD_BUTTON = "Open\n" +  
  "File"  
spa: "Cargar"  
frc: "Charger"  
roc: "\\程式\\載入"  
prc: "載入"  
deu: "Laden"  
swe: "Ladda"  
fin: "Lataa"  
por: "Carregar"  
pol: "\\Wybierz\\Program"  
ell: "Φόρτωση"
```

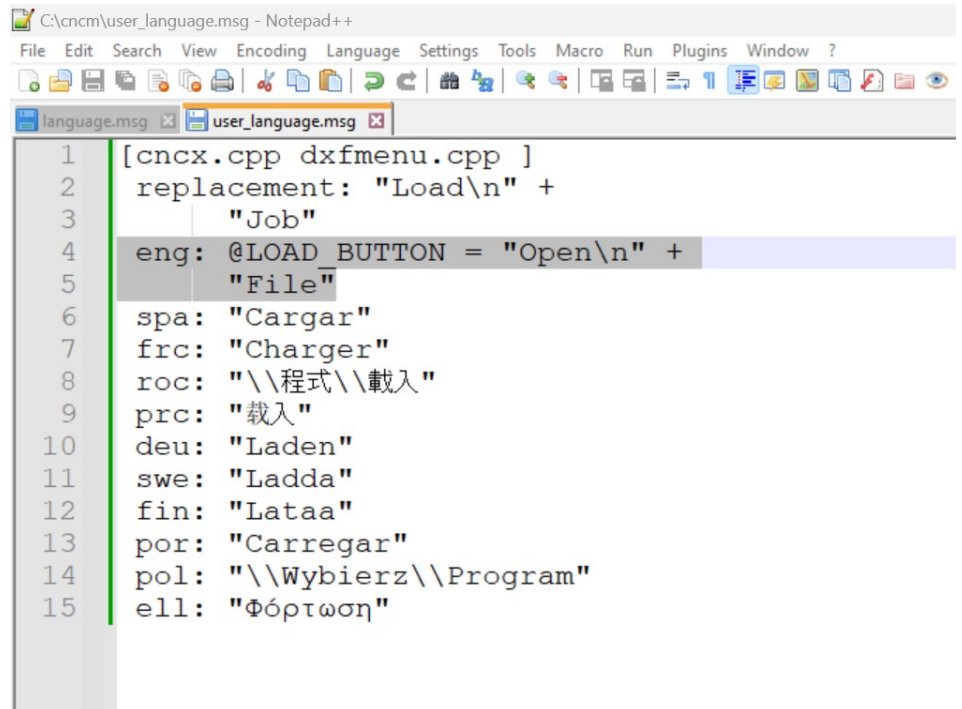

```
C:\cncm\user_language.msg - Notepad++  
File Edit Search View Encoding Language Settings Tools Macro Run Plugins Window ?  
language.msg user_language.msg  
1 [cncx.cpp dxfmnu.cpp ]  
2 replacement: "Load\n" +  
3   "Job"  
4 eng: @LOAD_BUTTON = "Open\n" +  
5   "File"  
6 spa: "Cargar"  
7 frc: "Charger"  
8 roc: "\\程式\\載入"  
9 prc: "載入"  
10 deu: "Laden"  
11 swe: "Ladda"  
12 fin: "Lataa"  
13 por: "Carregar"  
14 pol: "\\Wybierz\\Program"  
15 ell: "Φόρτωση"
```

Note: “\n” = new line (carriage return) so the word “File” appears on a new line (under the word “Open”)

Save the file and restart CNC12 and see the result.

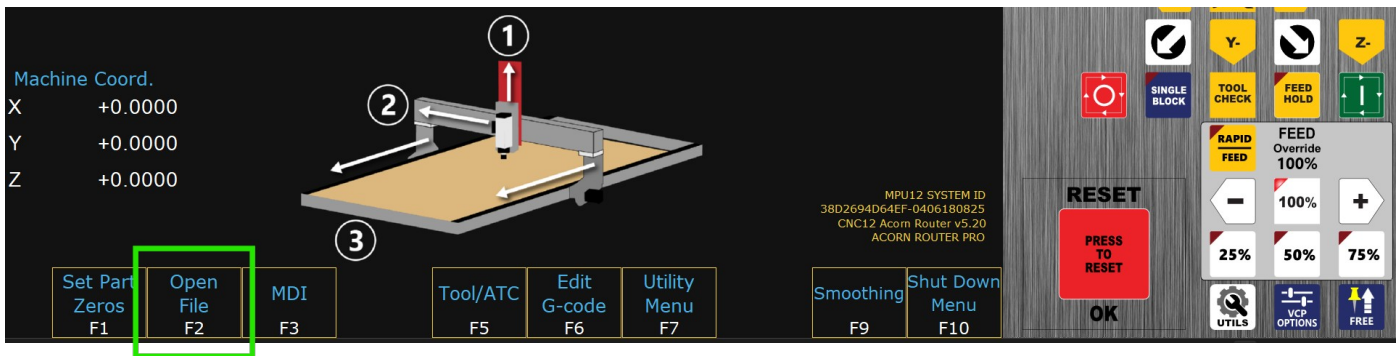

The advantage here is:

- Now we have a language file that tells CNC12 what to change without having to edit the Centroid default language file. This allows us to use the user\_language.msg file across all future versions of CNC12.
- Makes updating to a new version of CNC12 with your customizations easy. Simply copy your existing “user\_language.msg” file into the root CNC12 directory after a new CNC12 installation to have your changes take effect.
- Makes setting up multiple machine tools with a custom language file easy. Simply copy your “user\_language.msg” file into the root CNC12 directory after CNC12 installation.
- You can share your “user\_language.msg” with others using version v5.20+ of CNC12

## 11.) Operators Virtual Control Panel (VCP) additions

The VCP now supports using an image as the background in addition to solid colors. Below is an example of the VCP using a .jpg as the background. The .JPG being used is a brushed stainless steel texture image.

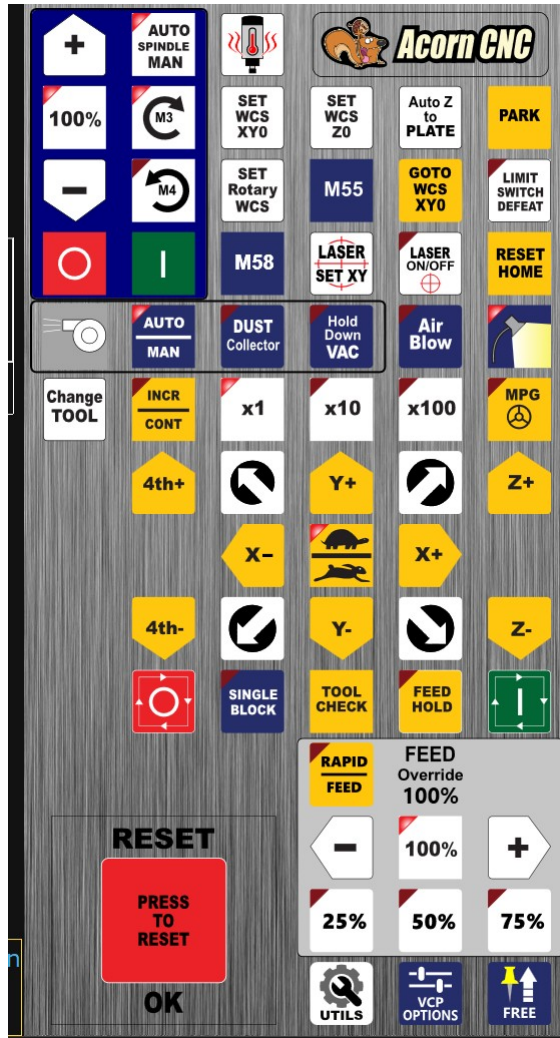

This sample .jpg file is included in the c:\ncm\resources\vcp\images folder

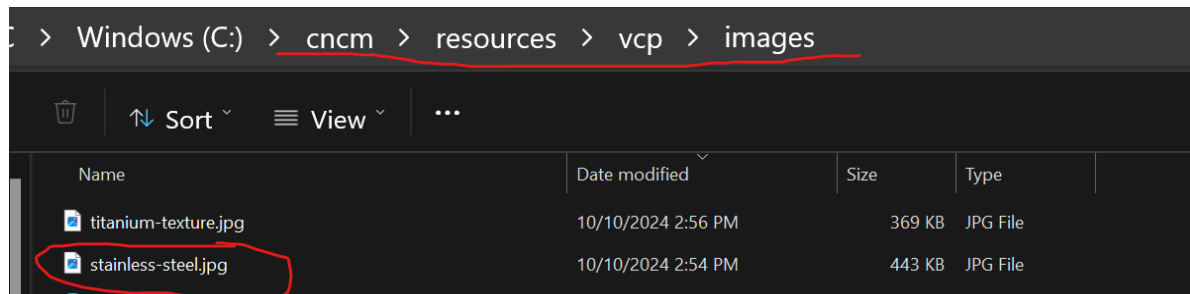

To instruct the VCP to use an image as a background:

Edit the VCP skin and add the new background node <background>

under <vcp\_skin> with the path to the image.

Highlighted in yellow below.

```
<vcp_skin>  
  <background>  
    c:\cncm\resources\vcp\images\stainless-steel.jpg  
  </background>  
<border>  
  <column_span>2</column_span>  
  <column_start>1</column_start>  
  <fill>#00007F</fill>  
  <row_span>4</row_span>  
  <row_start>1</row_start>  
  <outline_color>#000000</outline_color>  
  <outline_thickness>2</outline_thickness>  
</border>
```

#### Notes:

- VCP image nodes can now accept .jpg and .png (and possibly other, untested) image formats.
- The image should be larger in size (pixels) than the VCP for best results.
- The image upper right corner will be placed in the upper right corner of the VCP background.
- Any parts of the image that are larger than the VCP are simply cropped.
- An example skin has been included in the skins\custom\folder

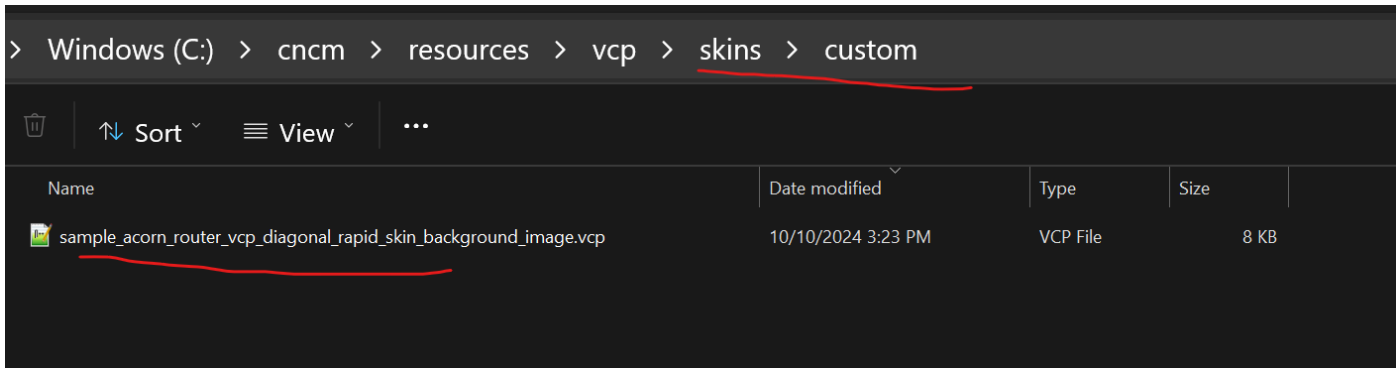

- The VCP group switching feature can now be triggered through parameters via

```
<trigger>  
  <parameter number="750">  
    <value>17</value>  
  </parameter>  
</trigger>
```

--- OR ---

```
<trigger>  
  <parameter number="750">  
    <bit>0</bit>  
  </parameter>  
</trigger>
```

in addition to the previous switching methods of: clicking on the vcp button and using a PLC output number state.

- VCP Preferences Menu: When notifying the VCP that you have customized the VCP using the Custom VCP YES/NO selection. There is now a choice to “link” the Rapid and Feedrate Override control for both on one control. This sets the parameters so that your custom VCP can use the new way of linking feedrate and rapid rate override control if desired.

Custom VCP Configuration	
Customized VCP skin in use	<input checked="" type="checkbox"/> Yes
Custom VCP Enable Rapid Override	<input checked="" type="checkbox"/> Yes
Custom VCP Enable Rapid Feed Link	<input type="checkbox"/> No

- The VCP Options menu will now open based on location of the VCP's lower right corner so its easier to see and less likely to be under CNC12 itself.

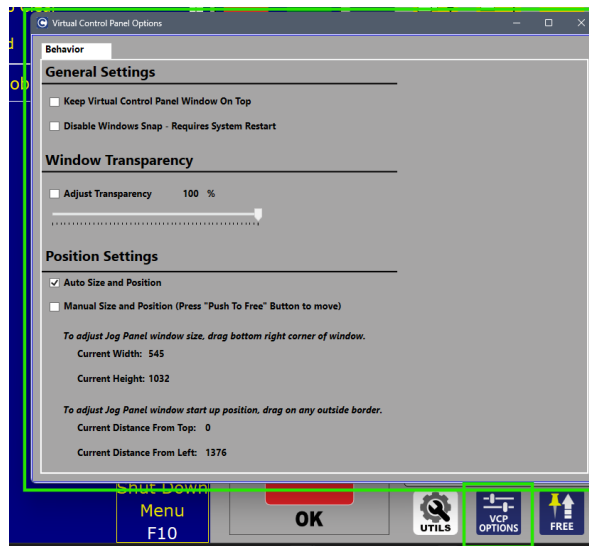

12.) Organized and grouped PLC messages into types so its easier to identify and manage. Users can edit which PLC message falls into which category by editing \cncm\Plcmmsg.txt if desired.

Fault messages use the 9000's, (Note: legacy 452 and 406 are included here as well). 9000 default colors are: Red and white.

Error messages use the 8000's, default colors: Yellow and Black

Warning messages use the 7000's, default colors: Blue and White

Other types of Messages use the 5000's default colors: Blue and Yellow

Ok Cleared type Messages use the 4000's  
4000 default colors: Green and White.

(Refer to CNC12 Operator Manuals for more information on all types of messages.)

We also added them to the Color Picker so users have full control over the color of the types of messages CNC12 produces.

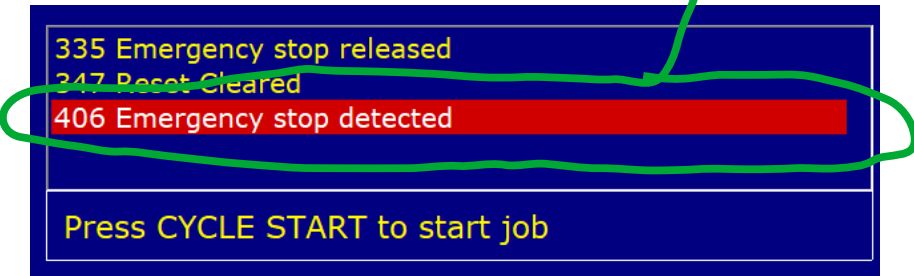
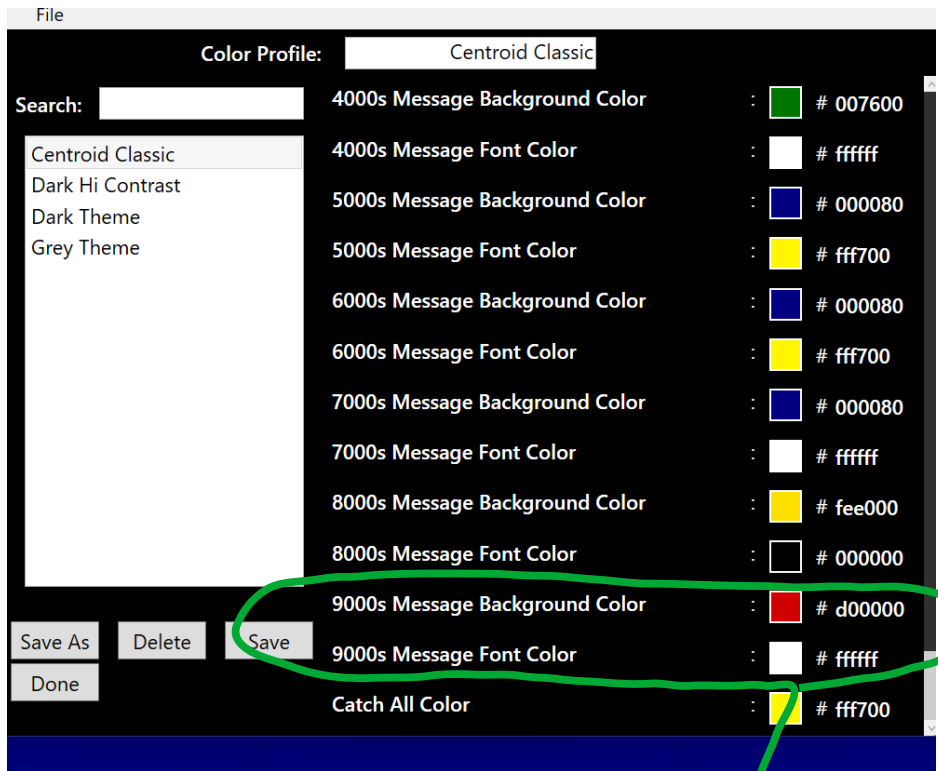

### 13.) Probing

- Added Probe Stylus Pre-travel calibration macro to the Probing menu and to the VCP Utils menu. This is a quick way to automatically calibrate and compensate for any probe stylus pre-travel amount.

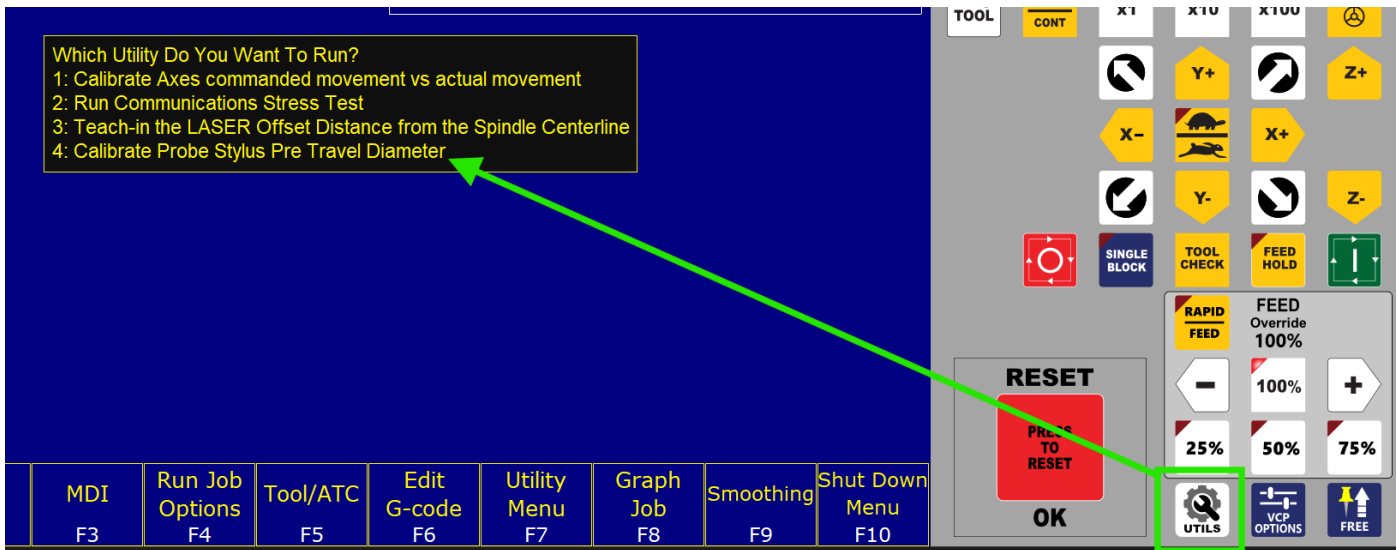

and directly in the probing menu as well.

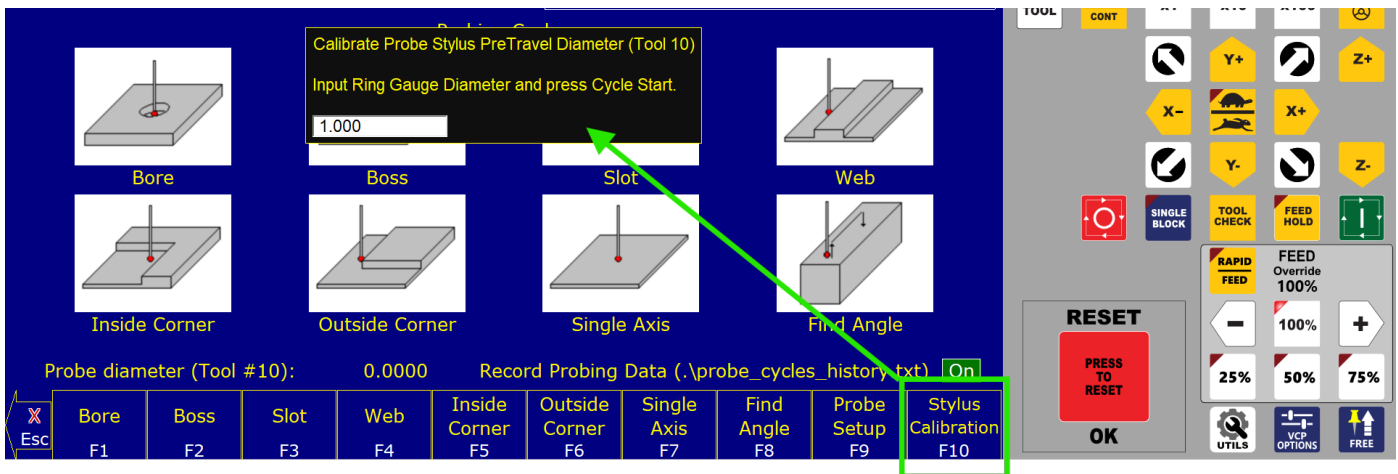

- The Probing menu can now record probing data to a text file.

File name and location are: \cncm\probe\_cycles\_history.txt.

This feature can be turned on and off by clicking on the On/Off button in the Probing Menu.

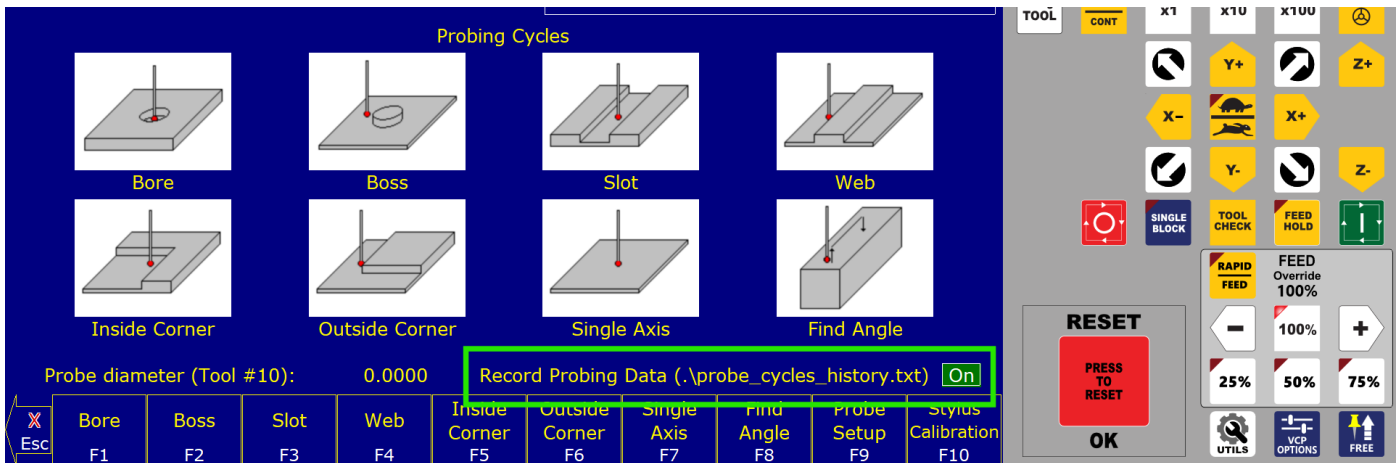

Open the file with any text editor to see the gathered data, edit and manipulate as desired for importation into CAD/CAM systems, Spreadsheets etc.

## Other Changes, Additions and Improvements

- Moved the Manual Run toggle in Lathe Run Menu to right hand column to fix graphical issue
- Added checks to part and feed menus to ensure at least once axis is set before entering menu
- Utility menu now uses an HTML file to display information which is customizable by users and oem alike.
- Run Menus rewritten which allows the toggle buttons to be clickable with or without the use of function keys.
- Added Reference Mark Homing wizard option to Hickory
- Added "Return Z to Home" option in the router touch plate menu
- Combined the Homing and Travel Menu and the Axes Pairing Menu in the wizard. Software travel limits moved to the Axis Configuration menu. These changes also removed the need for parameter 414.
- Added M25 to the goto\_part\_xy\_zero.cnc macro which will raise Z before it moves to the XY0 position
- Keyboard Jogging:
  - a.) Now you can jog machines diagonally using the PC keyboard using numbers 1,7,9 and 3.

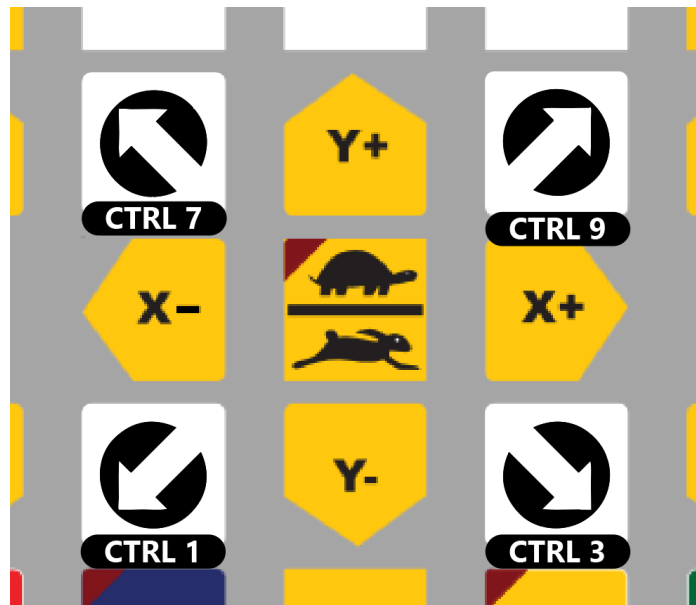

### PC Keyboard

CTRL 7 = X -, Y + at the same time

CTRL 9 = X +, Y+ at the same time

CTRL 3 = X +, Y - at the same time

CTRL 1 = X - , Y – at the same time

b.) Centroid default/Wizard generated PLC program change for improved keyboard jogging safety: When using PC Keyboard machine tool jogging, the PC Keyboard CTRL key activates the jog keys on the keyboard for safe Machine Axis Jogging via the keyboard. The CTRL key acts as a deadman safety switch. Preventing unintended movement of the machine tool while using the computer keyboard.



As always we recommend using the Centroid Operators control panel (either the Virtual one or the Hard panel), Your own hard wired Jog buttons ([see the USB-BOB web page for more information](#) on how to do that), a Hard wired MPG or the Wireless MPG ([see this page for more info on the Centroid Wireless MPG](#))

The Centroid PLC program is user editable, human readable, open source and the tools to customize/create/edit/debug/compile your own are free.

PC Keyboard Hot Keys Legend.

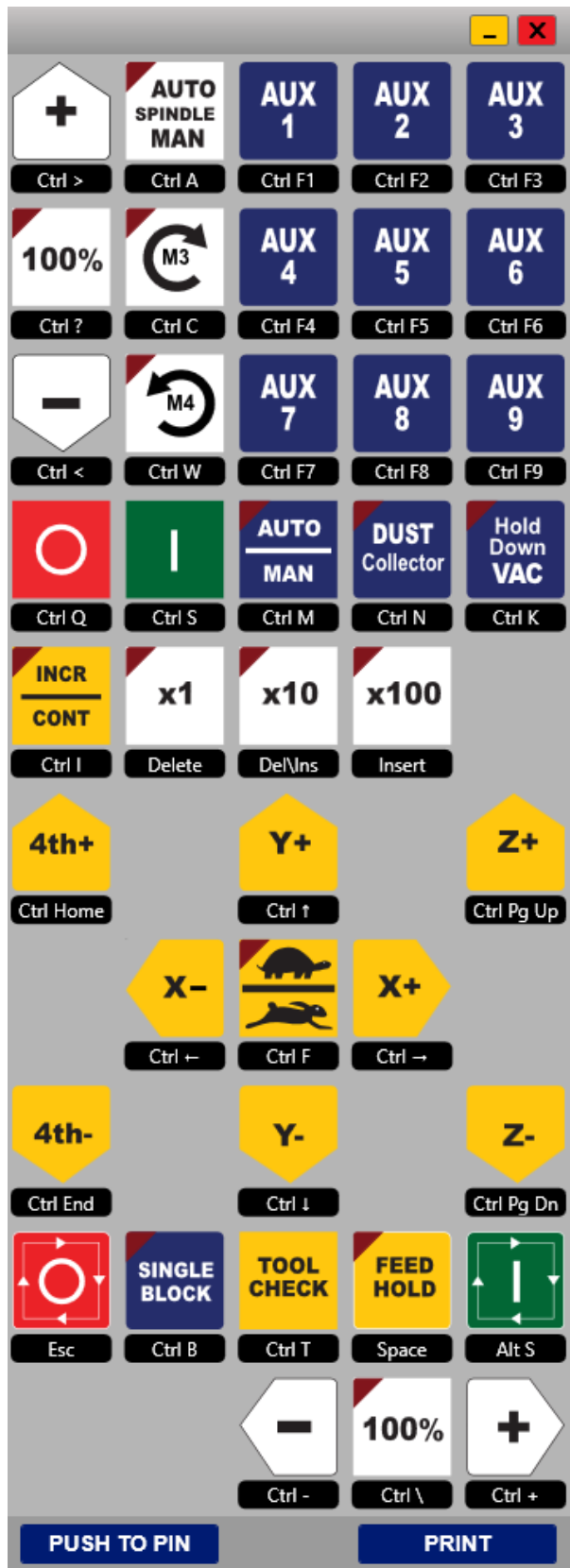

- Removed the license requirement for advanced macro functions.
- Deprecated API calls GetUserSystemVariable and GetUserStringSystemVariable. Added overloaded call GetSystemVariable to handle all system variables from #1 to #31999
- Added P181 to specify an additional ratio of a full motor revolution that an axis is allowed to move while searching for an index pulse before faulting out.
- Added bit 1 (add 2) P425 "Unhome machine after estop" to be able to unhome the machine after the reset button on the vcp is pressed.
- Added an "InverseTimeMode" to display 3D surface feedrate when G93.1 is in use. Rotary axes will display deg/min for rotary-only moves while G93.1 is not in use.
- Added Plasma Restart Mode debug mode when P389 == 1
- Increased which axes can be reversed by Plasma Restart Mode. Rotary jobs now work with Plasma restart traverse buttons
- Added horizontal auto scrolling for menus that don't fit horizontally on the screen. This is most useful when dragging/dropping inputs/outputs and multiple expansion boards are hooked up
- Limit switches will implicitly be set as home switches if no home or home limit switches are found in the wizard
- Removed Parameter 821 as it was unused for it's stated purpose
- Added dedicated Rack engage speed for Hole Rackmount ATC type
- Split Fork Engage/Disengage speed for Fork Rackmount and Sliding Carousel ATC types
- Removed unnecessary truncation of input/output names when dragging/dropping IO
- Added Simple PLC Diagnostics to Hickory
- Fixed issue where the SV\_?\_AXIS\_DRIVE\_ONLINE system variable, where ? is a single character axis label ABCXYZUVW, was not working correctly for ACDC drive types.
- PLC Installer: the button "Install - and keep the existing machine configuration" will not be enabled/visible if an mpu.plc program is not found in the corresponding cnct or cncm directory. It is assumed that if there is no mpu.plc program found, then this is a new install so the choice to keep the existing machine configuration would be a mistake. In addition, when choosing the "Install - and keep the existing machine configuration" option, we now copy over any plcmsg.txt since it is tightly coupled to mpu.plc.
- OEM use for custom CNC12 screen. P113 Bit 2
- Add 2 will hide F5 and F7 in CNC12 Router
- Add 4 will hide F1, F2, and F3 (the measurement buttons)
- Add 8 will hide Press Shift F12 help messages
- M222 is a new M code that uses key input. M222 is similar to M224 but takes any key input as an input. The file cncm\system\setup\_key\_defines.cnc lists the keys and the values that end up in the requested variable.

For example:

*M222 #101 "Verify Tool Touch Off device is functioning properly.\nPress any key to continue."*

use covered

- Add a new Mcode: M221. M221 is the same as M225 but doesn't stop the job.

*M221 #100 "Homing X axis"* (displays "homing X axis" as the g code still runs, does this until the job ends, the timer runs out or another message is triggered.)

- Added a P0 value to M115/116, M125/126 will move the probe until any touch device input is triggered.

*M115/X P0 F10* Move X axis in the negative direction until any touch device input is triggered. Works for any touch device, any touch input is triggered.

- Added Inline hyperlinks for Message Macros including but not limited to: M222,221,224,225 you can now use the html a href tag directly within the message m code.

*M221 #100 "<a href='centroidcnc.com'>This will take you to the best website ever</a>"*

only one hyper link per line. \n for a new line.

- Utility Menu now displays user editable HTML file. Typically used by OEM's to present their specific messaging. You can change any words, add images and hyperlinks.

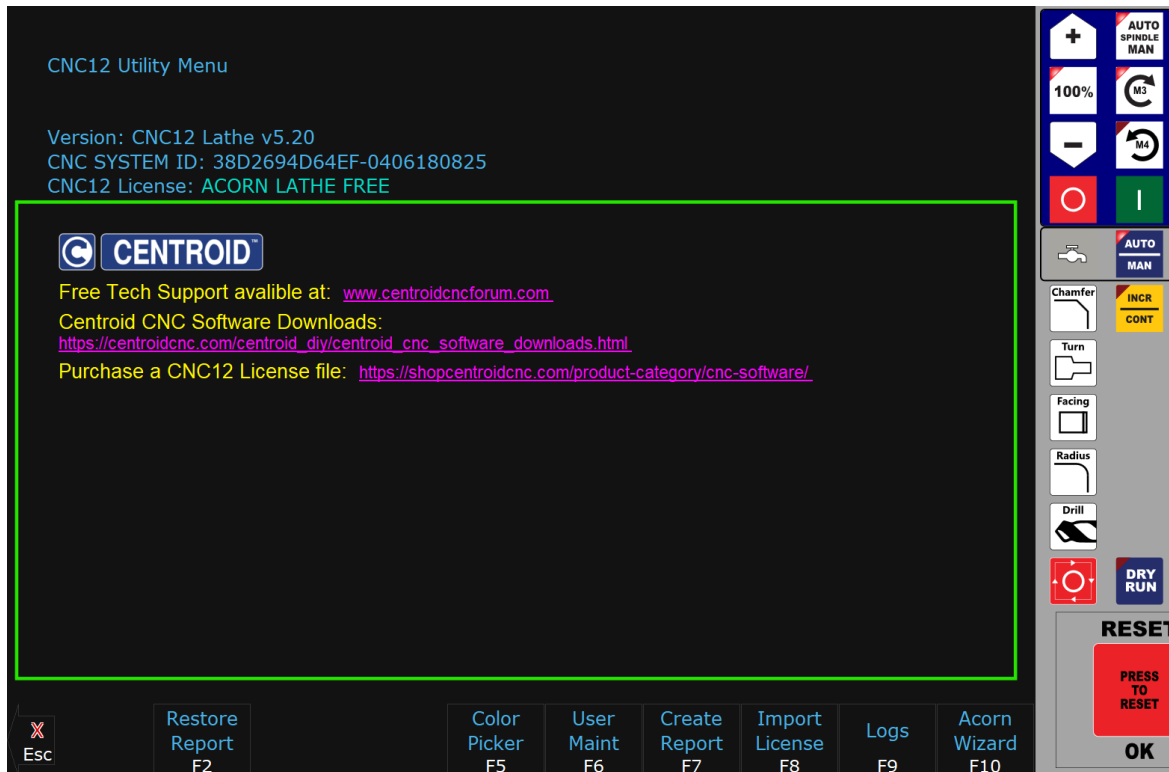

Edit the file c:\cncm\utility\_menu\_info.htm , restart CNC12 to see the changes.

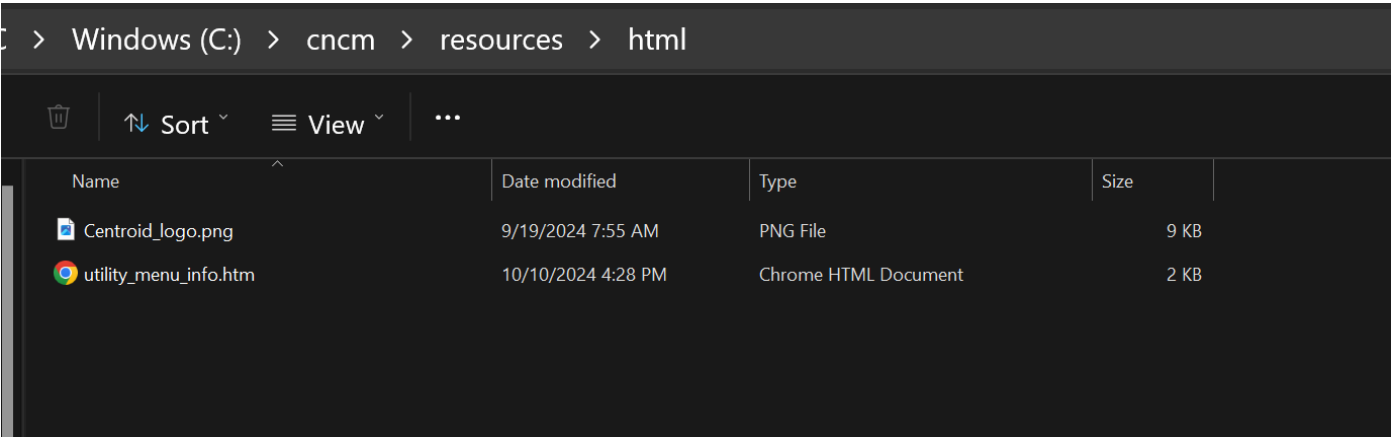

- Added Support for the Applied Motion EtherCat open loop stepper drive STF06-EC to Hickory CNC12  
This drive is only recommended use is for accessory motion (think ATC Carousel or Rack in/out type applications) this drive is NOT for cutting motion.

- New EtherCat Leadshine EL7 hex file improvements for better startup, axis pairing and homing performance.

- Improved the Wizards Print (CTRL+P) feature so the Wizard screens print nearly a full page width of 8.5x11 piece of paper

- The Function Key F3 Auto Measure in the Tool Library is now a user editable Macro.

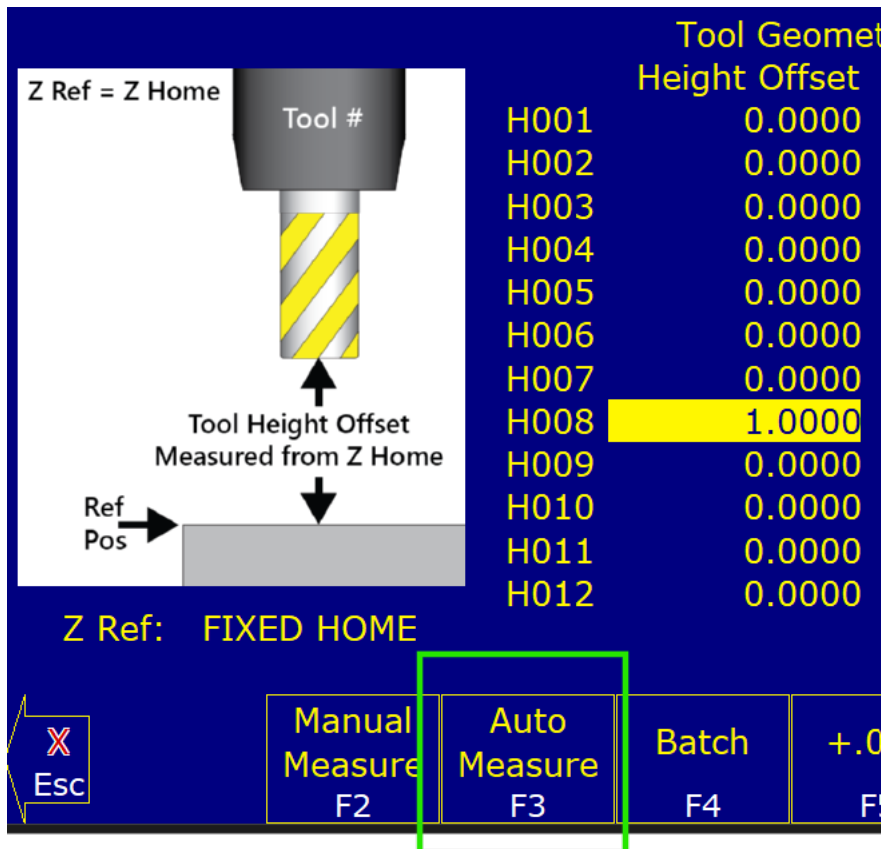

The CNC12 Router Version of this macro ask the operator if they would like to Automatically go to the Tool Touch Off fixed position or Manually Jog the Tool over the TT. Auto is used for measuring tools that can come straight down on the TT's location. Manually jog the tool over the TT position and then measure from that point is used for tools like Fly Cutters that can not come straight down on the TT for Auto Height Measurement. Manual in this case is actually semi automatic, the user simply jogs the Fly Cutter to a good XY position to measure the tool height from and then presses cycle start and the Auto Tool Height measurement TT cycle takes over.

Anyone can now make F3 do what every they want, just edit the macro located in the c:\cncm\system\tool\_offset\_auto\_measure.cnc

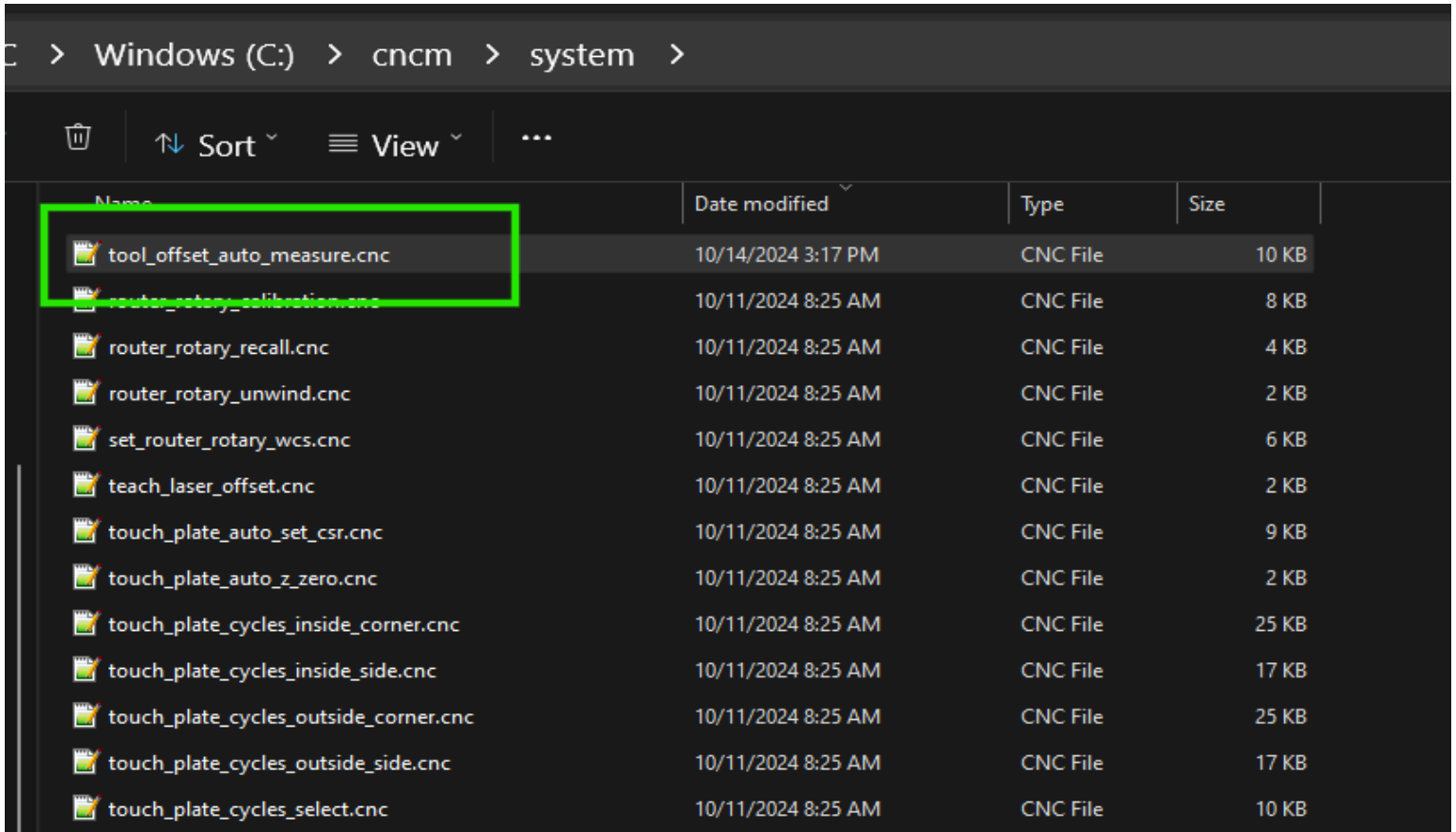

Related to that, we have been working through as many Function keys inside of CNC12 to break them out to user editable macros so they can be customized. These new macros can be found here. C:\cncm\system

This PC > Windows (C:) > cncm > system >

Name	Date modified	Type	Size
tool_offset_auto_measure.cnc	10/14/2024 3:17 PM	CNC File	10 KB
router_rotary_calibration.cnc	10/11/2024 8:25 AM	CNC File	8 KB
router_rotary_recall.cnc	10/11/2024 8:25 AM	CNC File	4 KB
router_rotary_unwind.cnc	10/11/2024 8:25 AM	CNC File	2 KB
set_router_rotary_wcs.cnc	10/11/2024 8:25 AM	CNC File	6 KB
teach_laser_offset.cnc	10/11/2024 8:25 AM	CNC File	2 KB
touch_plate_auto_set_csr.cnc	10/11/2024 8:25 AM	CNC File	9 KB
touch_plate_auto_z_zero.cnc	10/11/2024 8:25 AM	CNC File	2 KB
touch_plate_cycles_inside_corner.cnc	10/11/2024 8:25 AM	CNC File	25 KB
touch_plate_cycles_inside_side.cnc	10/11/2024 8:25 AM	CNC File	17 KB
touch_plate_cycles_outside_corner.cnc	10/11/2024 8:25 AM	CNC File	25 KB
touch_plate_cycles_outside_side.cnc	10/11/2024 8:25 AM	CNC File	17 KB
touch_plate_cycles_select.cnc	10/11/2024 8:25 AM	CNC File	10 KB
touch_plate_get_variables.cnc	10/11/2024 8:25 AM	CNC File	4 KB
touch_plate_move.cnc	10/11/2024 8:25 AM	CNC File	8 KB
Axis_Calibration.cnc	10/11/2024 8:25 AM	CNC File	10 KB
goto_machine_xy_zero.cnc	10/11/2024 8:25 AM	CNC File	2 KB
goto_machine_xyz_zero.cnc	10/11/2024 8:25 AM	CNC File	2 KB
goto_part_xy_zero.cnc	10/11/2024 8:25 AM	CNC File	2 KB
home_machine_cycle.cnc	10/11/2024 8:25 AM	CNC File	2 KB
homing_relay_square.cnc	10/11/2024 8:25 AM	CNC File	18 KB
MPGmacro1.mac	10/11/2024 8:25 AM	MAC File	2 KB
MPGmacro2.mac	10/11/2024 8:25 AM	MAC File	2 KB
MPGmacro3.mac	10/11/2024 8:25 AM	MAC File	2 KB
MPGmacro4.mac	10/11/2024 8:25 AM	MAC File	2 KB
perform_park.cnc	10/11/2024 8:25 AM	CNC File	2 KB
perform_spindle_warmup.cnc	10/11/2024 8:25 AM	CNC File	3 KB
perform_tool_change.cnc	10/11/2024 8:25 AM	CNC File	3 KB
probe_check_configuration.cnc	10/11/2024 8:25 AM	CNC File	6 KB
probe_stylus_calibration.cnc	10/11/2024 8:25 AM	CNC File	5 KB
select_laser_macros.cnc	10/11/2024 8:25 AM	CNC File	3 KB
set_laser_csr.cnc	10/11/2024 8:25 AM	CNC File	2 KB
set_part_all_zero.cnc	10/11/2024 8:25 AM	CNC File	4 KB
set_part_axis_zero.cnc	10/11/2024 8:25 AM	CNC File	7 KB
set_part_x_zero.cnc	10/11/2024 8:25 AM	CNC File	2 KB
set_part_xy_zero.cnc	10/11/2024 8:25 AM	CNC File	2 KB
set_part_y_zero.cnc	10/11/2024 8:25 AM	CNC File	2 KB
set_part_z_zero.cnc	10/11/2024 8:25 AM	CNC File	2 KB
set_tool_number.cnc	10/11/2024 8:25 AM	CNC File	2 KB
setup_defines.cnc	10/11/2024 8:25 AM	CNC File	19 KB
tool_library_tool_change.cnc	10/11/2024 8:25 AM	CNC File	2 KB
tool_offset_man_measure.cnc	10/11/2024 8:25 AM	CNC File	2 KB

- If no ATC F7 = Operator Manual Tool Change

Put the tool you want in the spindle and let CNC12 know which tool you loaded in the spindle manually.

WCS #1 (G54) Current Position (Inches) Job Name: NO\_JOB\_LOADED.cnc  
Tool: T1 H102 20001  
Feedrate: 100% 0.0 ipm Part Cnt: 0  
Spindle: 0 A Part # ↑: 0  
Rapid Rate: 100% 0:00:05

335 Emergency stop released  
347 Reset Cleared  
490 Reset Initiated, Press Reset to Clear  
347 Reset Cleared  
Press CYCLE CANCEL to cancel

Operator Manual Tool Change  
Enter Tool Number and press Cycle Start to continue.  
Input desired Tool #:

Tool #	H	D	H
H005	0.0000	D005	0.0500
H006	0.0000	D006	0.2500
H007	0.0000	D007	0.0000
H008	0.0000	D008	0.0000
H009	0.0000	D009	0.0000
H010	0.0000	D010	0.0000
H011	0.0000	D011	0.0000
H012	0.0000	D012	0.0000

Z Ref: FIXED HOME

Change Tool F7

If ATC present F7 Auto Tool Change will put and get tools automatically

WCS #1 (G54) Current Position (Inches) Job Name: NO\_JOB\_LOADED.cnc  
Tool: T1 H102 20001  
Feedrate: 100% 0.0 ipm Part Cnt: 0  
Spindle: 0 A Part # ↑: 0  
Rapid Rate: 100% 0:02:17

347 Reset Cleared  
490 Reset Initiated, Press Reset to Clear  
347 Reset Cleared  
313 Waiting for dwell time  
Press CYCLE CANCEL to cancel

Perform Automatic Tool Change  
Enter Tool Number and Press Cycle Start.  
(Machine will Put away the tool currently in the spindle and go Get the specified tool number.)  
Get Tool #:

Tool #	H	D	H
H006	0.0000	D006	0.2500
H007	0.0000	D007	0.0000
H008	0.0000	D008	0.0000
H009	0.0000	D009	0.0000
H010	0.0000	D010	0.0000
H011	0.0000	D011	0.0000
H012	0.0000	D012	0.0000

Z Ref: FIXED HOME

Change Tool F7

- Revised copy on the F6 ATC initialization button for clarity.

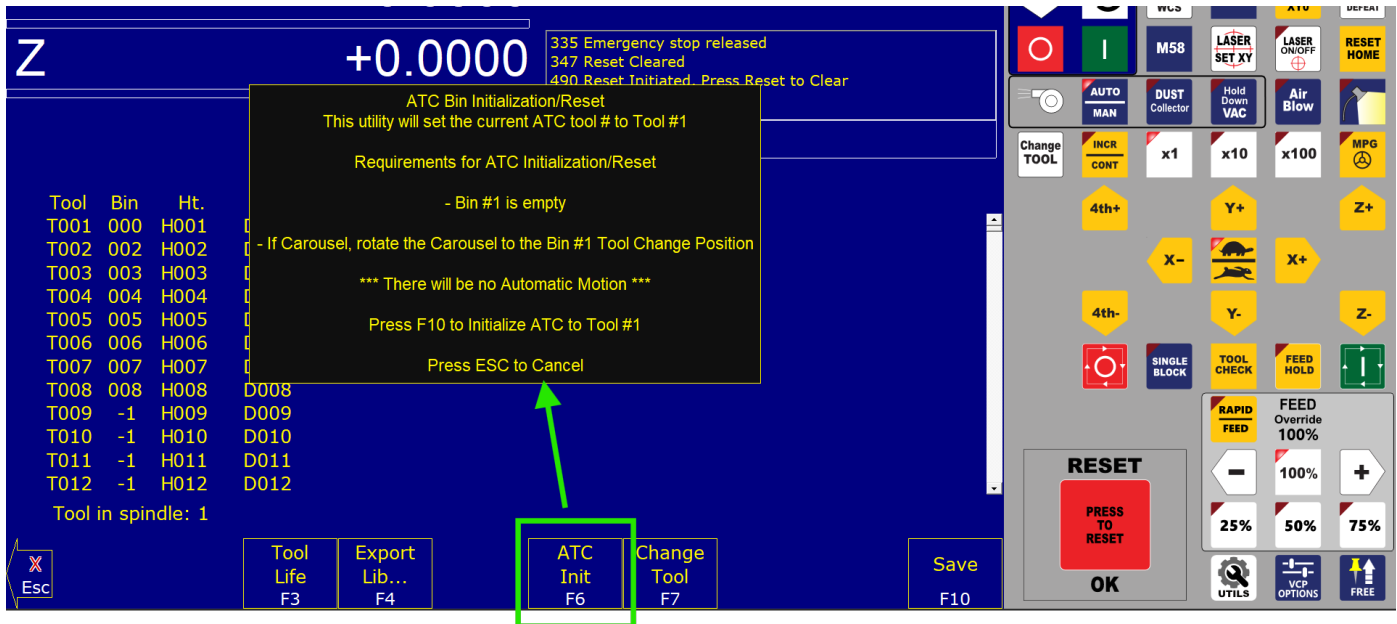

- With ATC and Fixed TT Batch Measure will automatically measure one or more tools at a time fully automatically.

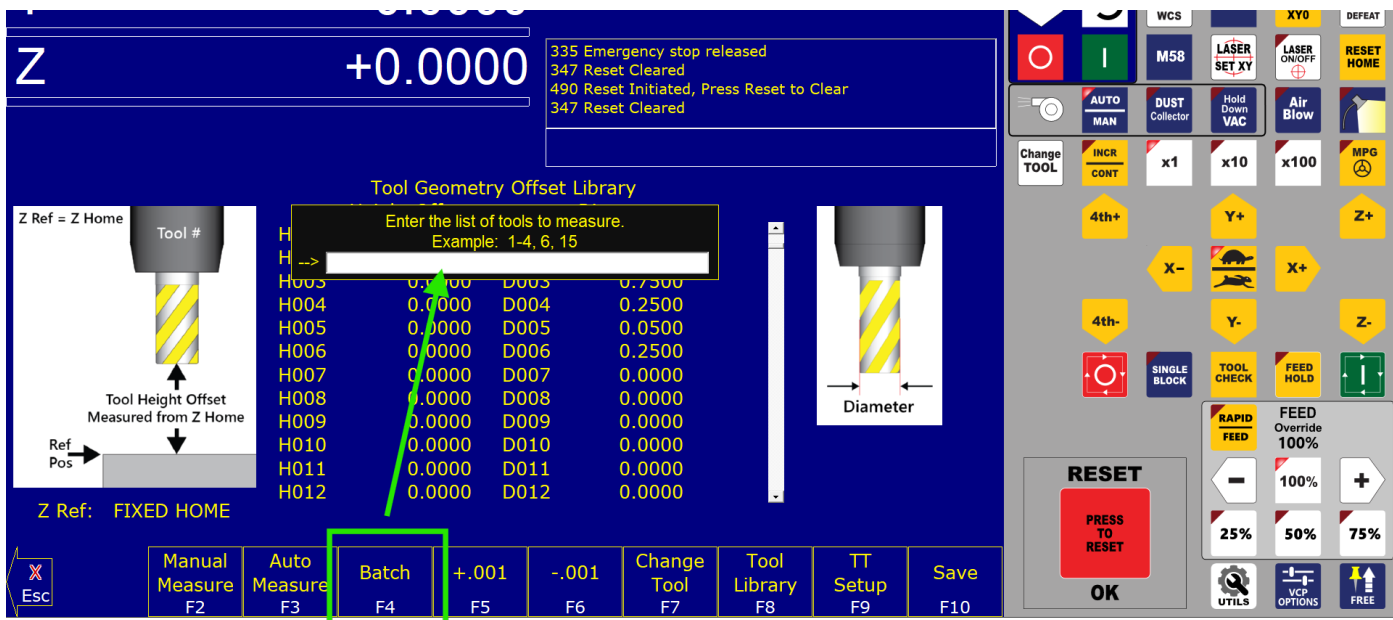

Examples:

- Enter "1" and press cycle start and machine will put current Tool away , pick up Tool #1 and go touch it off the fixed TT.

- Enter "1,3,5,6" and press cycle start and machine will put current tool away , pick up Tool #1 and go touch it off the fixed TT, then machine will put Tool #1 away, pick up Tool #3 and go touch it off the fixed TT, then machine will put Tool #3 away, pick up Tool #5 and go touch it off the fixed TT, then machine will put Tool #5 away, pick up Tool #6 and go touch it off the fixed TT

- Enter "1-4" and press cycle start and machine will put current tool away , pick up Tool #1 and go touch it off the fixed TT, then machine will put Tool #1 away, pick up Tool #2 and go touch it off the fixed TT, then

machine will put Tool #2 away, pick up Tool #3 and go touch it off the fixed TT, then machine will put Tool #3 away, pick up Tool #4 and go touch it off the fixed TT

- Changed this default setting to “Yes” so CNC12 will keep the current job loaded even in the event of a power loss. (Change this slider to NO if you don’t want this feature).

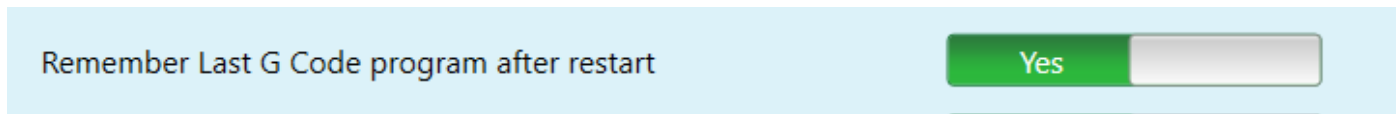

Added Default Jobs (g code programs) that will be loaded upon the very first start up of CNC12, instead of defaulting to “no\_job\_loaded.cnc” Any subsequent start/restart of CNC12 will of course remember what ever job you had loaded upon the next start/restart of CNC12.

These jobs below only load the very first time CNC12 starts so new users have a good g-code program to graph/edit/run etc the very first time they start and use CNC12.

Lathe default first time only job: PAWN.cnc (no encoder required version)

Plasma default first time only job: Bear23x23.tap

Mill default first time only job: sample\_atlanta.cnc

Router default first time only job: sample\_sign\_smooth\_on.cnc

If you want “no\_job\_loaded.cnc” to be loaded automatically upon a CNC12 start/restart change the slider to No.

- Fixed a rare but annoying windows wxwidgets message related to loading a g code file remotely.

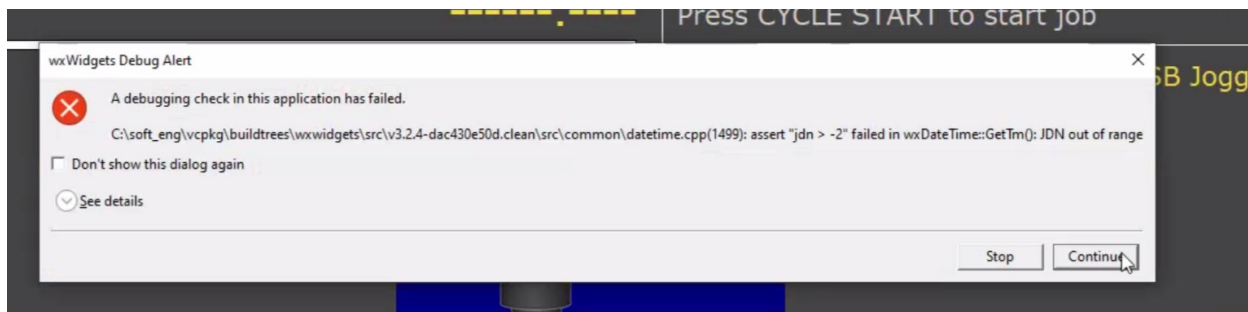

When Setting Parameter 4 = 26 (default is 25) this will sometimes cause a windows wxwidgets error message when the date/time stamp or path of the remote file was missing or corrupted.

When using P4=26, CNC12 caches a copy of a g-code program locally from a remote drive, this feature was useful back in the day of small hard drive space, not so much anymore. ( Recommended setting for Parameter 4 these days is 25 and the default is P4=25.

New CNC12 Message added to let the operator know that the remote file is missing or corrupted etc.

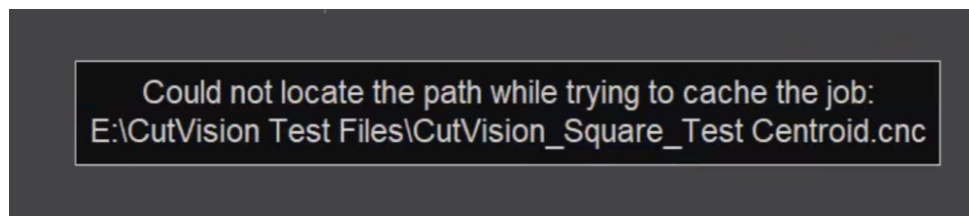

More information on Parameter 4 can be found in the CNC12 Operator manuals.



- Added a note on the Wizard start up screen about undocumented Wizard feature "Print to paper or PDF"



- Moved the Wizard Axis travel limits into the Axis Configuration menu

Router CNC Control Configuration Wizard

**Primary System**

- Axis Drive Type
- Input Definitions
- Output Definitions

**Axis**

- Axis Configuration**
- Homing and Pairing
- Advanced Hardware
- Rotary Setup

**Spindle**

- Spindle #1
- Rigid Tapping
- PWM Setup

**Touch Devices**

- Touch Probe
- Tool Touch Off
- Touch Plate

**Control Peripheral**

- Input Devices
- Centroid USB-BOB
- Wireless MPG

**Drive Signal Mapping**

- Mapping

**ATC**

- ATC Setup

**Preferences**

- CNC Control
- VCP Preferences

**Axis Configuration**

	Axis 1	Axis 2	Axis 3	Axis 4
Linear or Rotary	Linear	Linear	Linear	Rotary
Label	X	Y	Z	N
Steps / Revolution	2000	2000	2000	1600
Overall Turns Ratio <small>mm/turn or deg/rev or revs/turn</small>	1.25	1.25	2.5	4
Lash Comp. <small>millimeters</small>	0	0	0	0
Max Rate <small>mm/min or deg/min or rev/min</small>	1200	1200	600	360
Fast Jog Plus Direction <small>mm/min or deg/min or rev/min</small>	1000	1000	500	360
Fast Jog Minus Direction <small>mm/min or deg/min or rev/min</small>	1000	1000	250	360
Slow Jog <small>mm/min or deg/min or rev/min</small>	100	100	80	36
Accel / Decel <small>seconds</small>	.375	.375	.375	0.5
Direction Reversal	N	N	N	N
Drive Enable Delay <small>milliseconds</small>	250	250	250	250
Travel Limit (+)	52	102	0	0
Travel Limit (-)	0	0	-11	0

x1 Linear Jog Increment  
millimeters      .01 (P040)

x1 Rotary Jog Increment  
degrees      0.1 (P041)

Maximum number of steps that can be pulsed per second (P968)      200,000 steps/second

Axis Motor Drive fault delay time (P991)      1000 milliseconds

Connected to CNC12

Write Settings to CNC Control Configuration

- Made the offset library increment parameter #70 unit-less so now when switching from inches to mm CNC12 will NOT convert this value from mm to inches or vs. verse.

Default value for P70 is .001, (when in inches this is .001" when in mm this is .001 mm.)

009	0.0000	029	100.0000	049	0.0000	069	1.7500	089
010	0.0000	030	126.6667	050	0.0000	070	0.0010	090
011	0.0000	031	0.0000	051	0.0000	071	0.0000	091
012	10.0000	032	25.0000	052	0.0000	072	0.0000	092
013	1.2700	033	1.0000	053	0.0000	073	1.2700	093
014	304.8000	034	8000.0000	054	0.0000	074	4.0000	094
015	127.0000	035	0.0000	055	0.0000	075	0.0000	095
016	254.0000	036	0.0000	056	5.0000	076	0.0000	096
017	0.0000	037	3.0000	057	0.0000	077	0.0000	097
018	0.0000	038	0.0000	058	0.0000	078	0.0000	098
019	0.0000	039	100.0000	059	0.0000	079	0.0000	099

Offset Library Inc/Decrement Amount

Tool Geometry Offset Library

Height Offset	Diameter
H001 0.0000	D001 0.2500
H002 0.0000	D002 0.5000
H003 0.0000	D003 0.7500
H004 0.0000	D004 0.2500
H005 0.0000	D005 0.0500
H006 0.0000	D006 0.2500
H007 0.0000	D007 0.0000
H008 0.0000	D008 0.0000
H009 0.0000	D009 0.0000
H010 0.0000	D010 0.0000
H011 0.0000	D011 0.0000
H012 0.0000	D012 0.0000

Z Ref: FIXED HOME

Manual Measure F2    Auto Measure F3

+ .001 F5    - .001 F6    Change Tool F7    Tool Library F8    TT Setup F9    Save F10

Change the value in P70 to change the amount the F5 and F6 adjustment keys increment the values by.

Example below is millimeters with P70 set to .01 value.

The screenshot displays the 'Tool Geometry Offset Library' on a CNC control screen. It features a diagram on the left showing a tool with a height offset measured from the Z Home position. A central table lists tool IDs (H001-H012) and their corresponding height offsets (all 0.000) and diameters (D001-D012). A diagram on the right shows a tool with its diameter indicated. At the bottom, a function key menu includes 'Manual Measure' (F2), 'Auto Measure' (F3), '+.01' (F5), '-.01' (F6), 'Change Tool' (F7), 'Tool Library' (F8), 'TT Setup' (F9), and 'Save' (F10). The F5 and F6 keys are highlighted with a green box.

Tool Geometry Offset Library			
	Height Offset		Diameter
H001	0.000	D001	6.350
H002	0.000	D002	12.700
H003	0.000	D003	19.050
H004	0.000	D004	6.350
H005	0.000	D005	1.270
H006	0.000	D006	6.350
H007	0.000	D007	0.000
H008	0.000	D008	0.000
H009	0.000	D009	0.000
H010	0.000	D010	0.000
H011	0.000	D011	0.000
H012	0.000	D012	0.000

- Added 'CTRL-G' to the PLC Detective, which opens a Goto Line Dialog
- PLC Detective can now search both up and down using F6 – Search
- Fixed missing Touch Plate PLC messaging

## Known Issues

1.) Oak, Allin1DC and MPU11 users should be aware: running the CNC12 v5.20 on top of the existing cncm\ directory will overwrite your WCS file with a new, blank file.

That will remove your software travel limits; zero out any custom return points (such as a fixed tool setter location, or the G30 Z coordinate for an umbrella or swing-arm tool changer); and zero out all your work offsets.

But have no fear it is simple to recover the .wcs file.

You can recover normal operation by restoring the last-known-good report from before the update, or by extracting the cncm.wcs file from such a report and copying it into the c:\cncm directory.

So as always be sure to create a fresh report.zip file BEFORE running the CNC12 installer.

1. Rotary axis labels and G code now work in any combination parallel to the X or Y axis.  
Same with g code backplot graphing of Rotary moves in any combination of other axes.

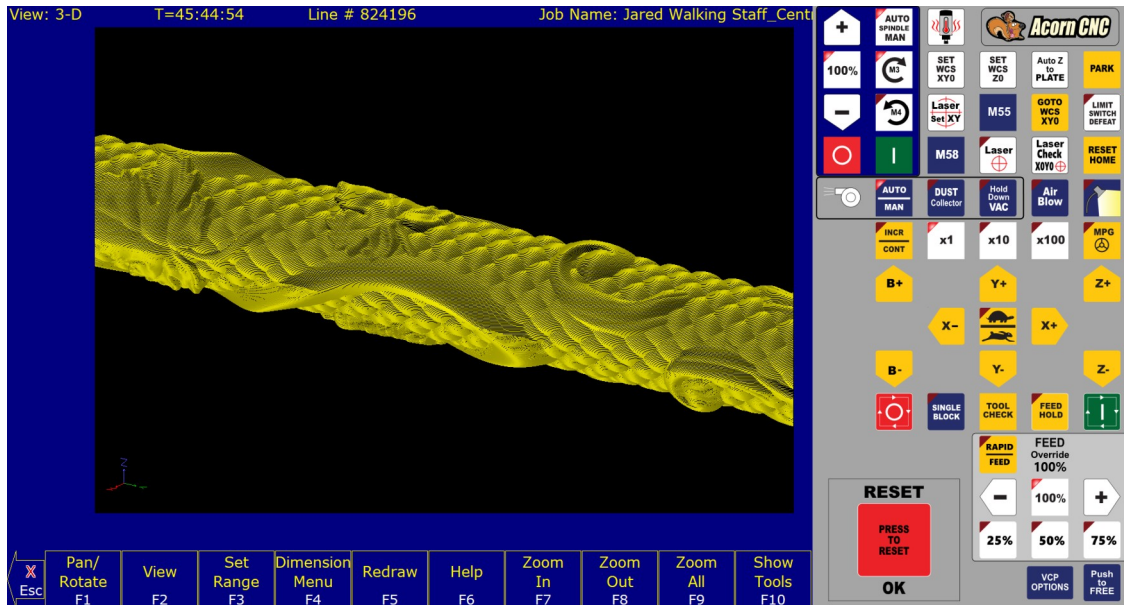

2. Added a Rotary setup page added to Wizard

### Rotary Setup

Rotary Axis	A
Axis Parallel To Rotary Center Line	<input type="text" value="X"/>
Center of Axis (Y) in machine coordinates	<input type="text" value="10"/> (P116)
Center of Axis (Z) in machine coordinates	<input type="text" value="12"/> (P117)
Rotary Axis Jog Increment	<input type="text" value="0.1"/> degrees (P041)
Rotary DRO Display Type	<input type="radio"/> <input checked="" type="radio"/> Rotations
Slave Rotary axis feedrate to a linear move feedrate on the same line*	<input type="radio"/> <input checked="" type="radio"/> No (P002)
Rotary-only moves won't use a modal feedrate set by a prior rotary and non-rotary move*	<input type="radio"/> <input checked="" type="radio"/> No (P002)

*\*This feature has no effect for movement commands handled by Smoothing (P220=1)*

- M151 now also works with any rotary axis. (previously only available in CNC12 Lathe for C axes) M151 when used with a Rotary axis acts as a “DRO unwind”. M151/A will reset the DRO to a value between 0-360 degrees. So for instance if the Rotary axis has “wound up” past 11 turns and is at 11R121.462 (121.462 degrees)

A screenshot of a CNC control display. The background is dark blue. On the left, the letter 'A' is displayed in large white font. To its right, the text '+11R121.462°' is displayed in white font. The display is framed by thin white lines.

Issue an M151/A and the DRO changes to:

A screenshot of a CNC control display. The background is dark blue. On the left, the letter 'A' is displayed in large white font. To its right, the text '+121.462°' is displayed in white font. The display is framed by thin white lines.

Effectively “un winding” the Rotary axis with NO MOTION. Resetting the DRO position at the same degree position but removing the number of full rotations.

For example: Then a G0A0 would result in a 121.462 degree movement to get back to A0

Use MDI or put the M151 in your G code program or assign a VCP button if you find yourself doing this a lot.

M151 Demonstration Video. <https://youtu.be/hl4VmpGTG30>

- Improved smoothing speed control for low step resolution per linear inch PLASMA machines. Turn on/off this new experimental feature on with Parameter 225.  
Set P225 = 1 to turn ON.  
Set P225 = 0 turn OFF (use the ‘old’ high resolution step smoothing)  
P225 is only available with Plasma CNC12.  
This experimental feature fixes the “feedrate going faster than profile manager set rate in certain conditions” on low resolution machines with short vector g code programs. ( low step resolution = turns ratio near or below 1 with 1600 steps per revolution drive settings. ) This is a software fix for machine mechanical short comings. When every possible mechanically design and build the machine kinematics with good motor step per inch resolution. [See this post for more info.](#)

- Added Utility button VCP with stock macro for common utility style functions (user editable and removable of course just like any other VCP button. Plasma Shown below.

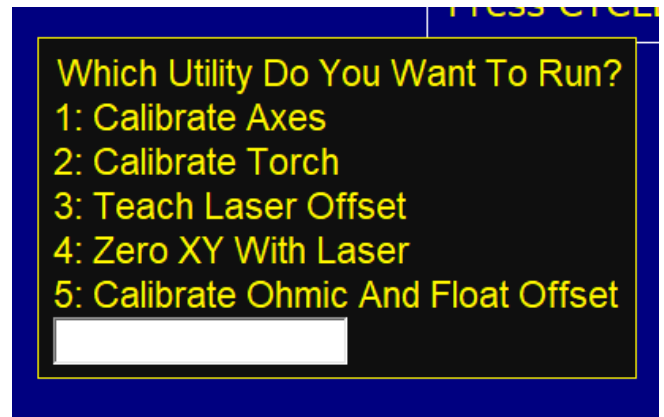
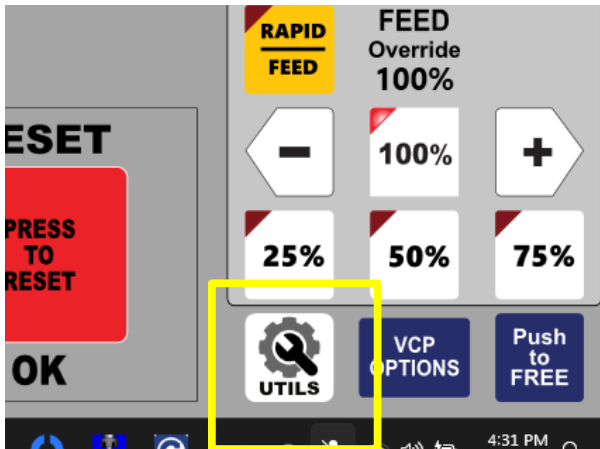

- "Added additional probe protection based on the probe tool number for single input Touch Probes. Now a NC Probe will work without the additional Probe Detect Input as long as the loaded Tool Number matches the value of parameter 12 (The Touch Probe Tool Number). Said another way probe protection will be active when the tool number of the Probe is also active in CNC12. There are no changes to any previously supported probe trigger and detect input configurations."
- Added frequency tracking of ethernet packet communication send and receive errors with a Windows style pop-up warning to the operator when more than 100 send and receive errors have been logged within 1 hour.  
  
Parameter 267 controls the tracking frequency.  
P267 default value is 100.3 which is 100 messages per hour.  
100 messages per minute would be 100.2  
100 messages per second would be 100.1  
The number before the decimal represents the number of messages, the number after the decimal represents the unit, 1 = second, 2 = minute, 3 = hour  
Neglecting the decimal part would result in messages per hour (so just a value of 60 would be 60 messages per hour).
- On\_hover, on\_click VCP button graphical feature omission restored.
- Fixed screw comp axis labeling issue with AcornSix, now screw comp for an axis with a label will be applied to the paired axis labeled "N" as well. (in v5.08 to get screw comp to work the paired axis needs to be labeled (not "N")
- Plasma Restart Mode now has an "ignore list" that is used to tell Plasma Restart mode to ignore certain advanced g code techniques that are not compatible with Plasma Restart Mode. G code jobs with any thing that is on the ignore list will not have a restart file created nor will the job be recovered upon an interrupt (collision). This is list used to stop Restart mode from failing on advanced parametric style g code that has been variabilized.
- Plasma Restart Mode received a graphics engine upgrade and is now controllable with the mouse in addition to the traverse buttons, Zoom while in restart mode, Select Lead in point, Select pickup point, Select Pierce Point with mouse. All existing restart features are retain along with the new features.  
Joey's [Video link showing new restart features. https://photos.app.goo.gl/6oxqww51MPv1b9h37](https://photos.app.goo.gl/6oxqww51MPv1b9h37)

12. Added the ability to easily change profile sets in the plasma profile manager (between different amp rating units Powermax 45, 85, 105 and sync, etc.). No need to copy/rename profile folders in windows anymore.

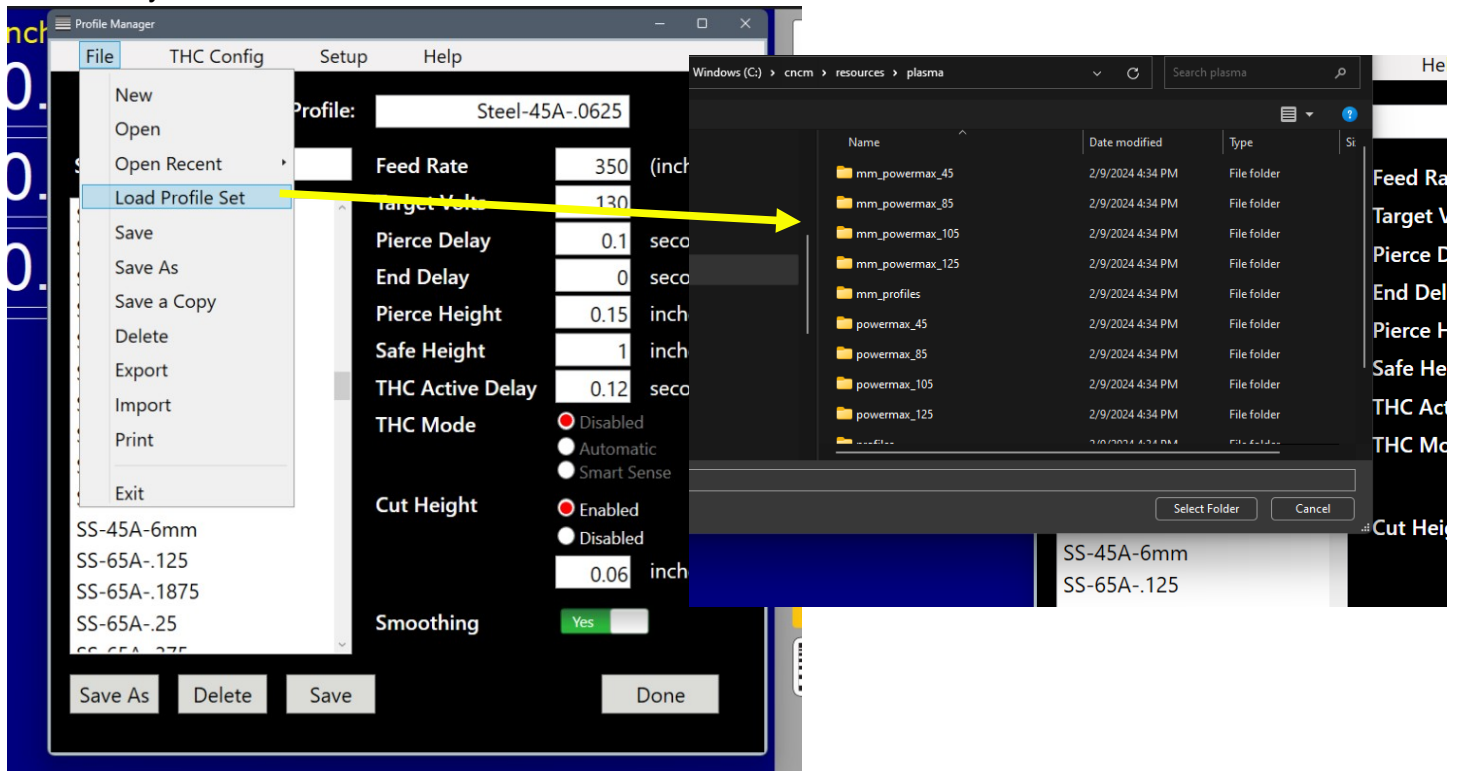

13. Fixed issue where the G10 command was limiting the R word value to the min/max parse distance settings (999999.9999).
14. G65 will now accept L0 as a valid repeat option, resulting in the G65 call being skipped
15. Added CentroidAPI calls GetSerialNumber and ImportLicense
16. Moved startup options from the properties in the shortcut to a file called startupOptions.ini. This allows for startup options to be defined when launching the program directly from the executable
17. Deprecated Centroid API calls: CNCSkinning.dll and CNCSkinningUserControls.dll. And replaced them with CentroidAPI.dll and CentroidAPIUserControls.dll, all previously deprecated functions have been removed. A 32 bit copy of CNCSkinning.dll will remain in the cncm/t directory for support of user created applications but will no longer receive updates.
18. Fixed API Call "GetCurrentHeightOffsetNumber" in Acorn
19. Added usb dongle status to the offline intercon title bar to make it very obvious that the USB key is found and working or not.

20. Added Smart Search Groups, controlled by a file called smart-search-options.ini, which allows for user controlled smart search groups

Upon startup, cnc12 will create a file called smart-search-options.ini preloaded with version, spindle modal macros, coolant modal macros, and clamp modal macros.

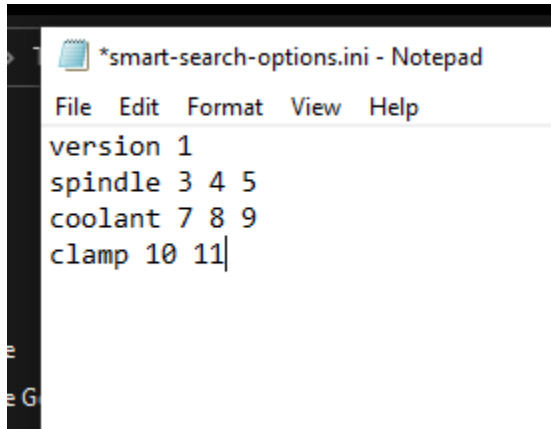

```
*smart-search-options.ini - Notepad
File Edit Format View Help
version 1
spindle 3 4 5
coolant 7 8 9
clamp 10 11
```

Up to 9 additional groups can be added by a user in the form of “usergroupX” where X is the user group number, 1-9

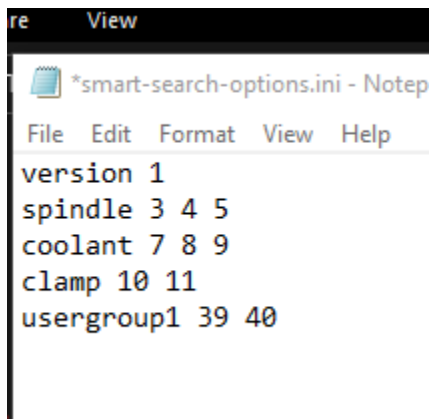

```
re View
*smart-search-options.ini - Notep
File Edit Format View Help
version 1
spindle 3 4 5
coolant 7 8 9
clamp 10 11
usergroup1 39 40
```

Then when run-search is used, this file will enable the last known macro in each group. For example, consider the following G-code

```
N104 ; TOOL - 01 DIA. - .2500 2D-SWEPT..
N106 M25 G49 ; Goto Z home, cancel tool length offset
N108 G17 G40 ; Setup for XY plane, no cutter comp,
N110 G20 ; inch measurements
N112 G80 ; cancel canned cycles,
N114 G90 ; absolute positioning,
N116 T1 M06
N118 S2000 M39
N120 G00 G54 X1.125 Y0.
N122 G43 H1 Z1.
N121 G1 X1.125 Y0 Z-.75
N124 G1 Y.75 Z-.75 F24.
N126 G2 X1.25 Y.875 R.125
...
N316 X-.1192
N318 Z-.6649 F12.
N320 Y.75 F24.
N322 G2 X1.25 Y2.1192 R1.3692
N324 G1 X2.
N326 Y2.125
N328 Z-.75 F12.
N330 X1.25 F24.
N332 G3 X-.125 Y.75 R1.375
N334 G1 Y0.
N336 G0 Z1.
N338 G40
N340 M25 G49 H0
N342 G00 X0. Y0.
N344 M40
; End of program
```

Searching for line 124 will turn on M39 as it is the last known macro in that group, as it is written in line 118.

21. Fix a random ghost character graphics anomaly that would present itself in MDI mode
22. Switch to using the Feedrate Override % to override the Jogging speeds from the Rapid Override.
23. Added Centroid API call "SetToolLibrary" which allows the entire tool library to be changed in a single call
24. Simplified PLC Diagnostic App: Added Ctrl+alt+r to the simple plc diagnostic App to auto restore any user inverted/forced buttons back to the initial state when starting the App. Hopefully this will help users that get themselves mixed up since they forgot to turn an output back to "normal" or forgot to uninvert an input.

- 25. Fixed bug where when using the Simple PLC Diagnostic tool would crash when selecting the help or options buttons
- 26. Added command "-getversion" to the CNC12 installer to print the installed version to a file.
- 27. Rotary graphics are now applied to run-time graphics. This is temporarily limited to a top-down view only. This also includes a triangle tool indicator for rotary jobs

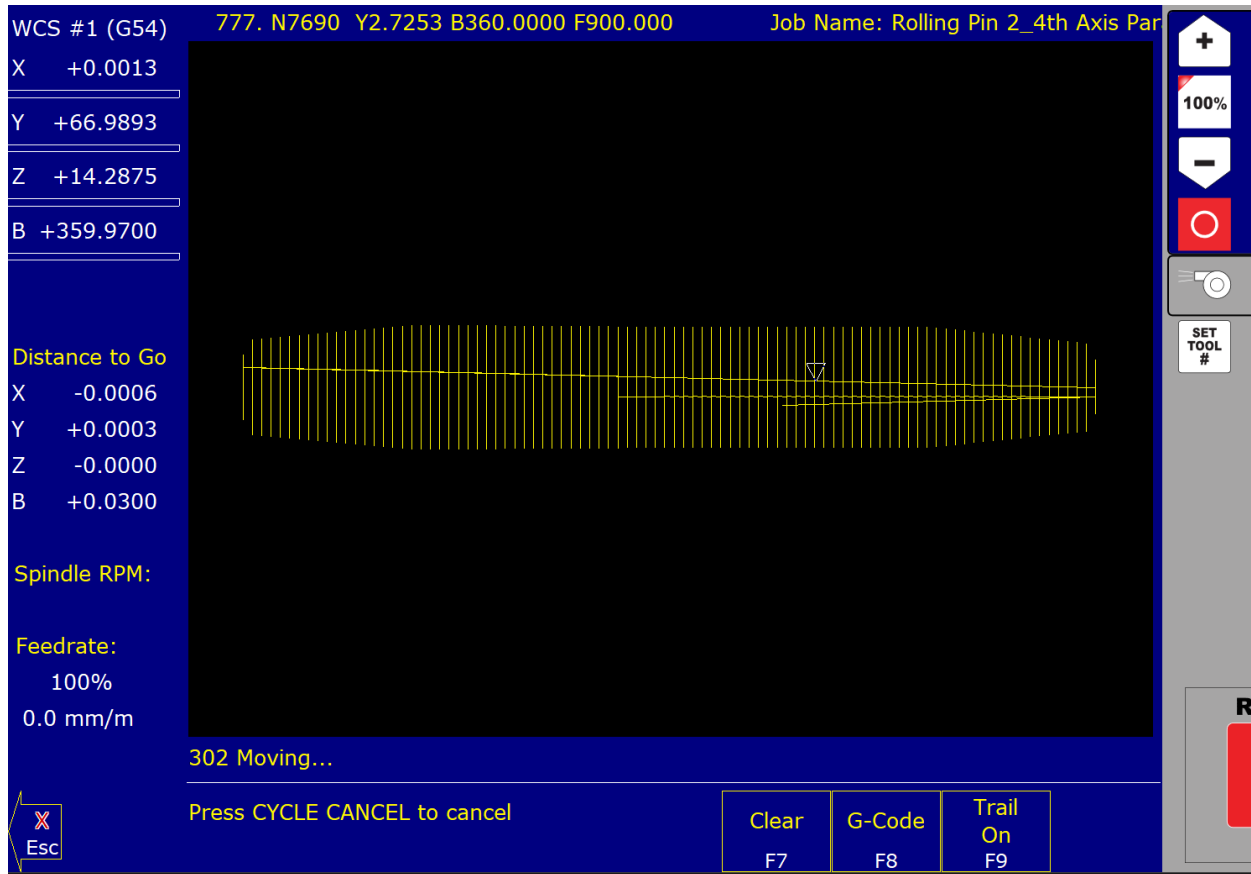

- 28. Jogging speed override now uses Feed Override percentage for speed calculation instead of Rapid Override speed percentage.

29. CNC12 Router and Plasma have improved Cross Hair Laser VCP buttons and macros. Now one button does as many Cross Hair laser functions as you want. This is a simple user editable macro.

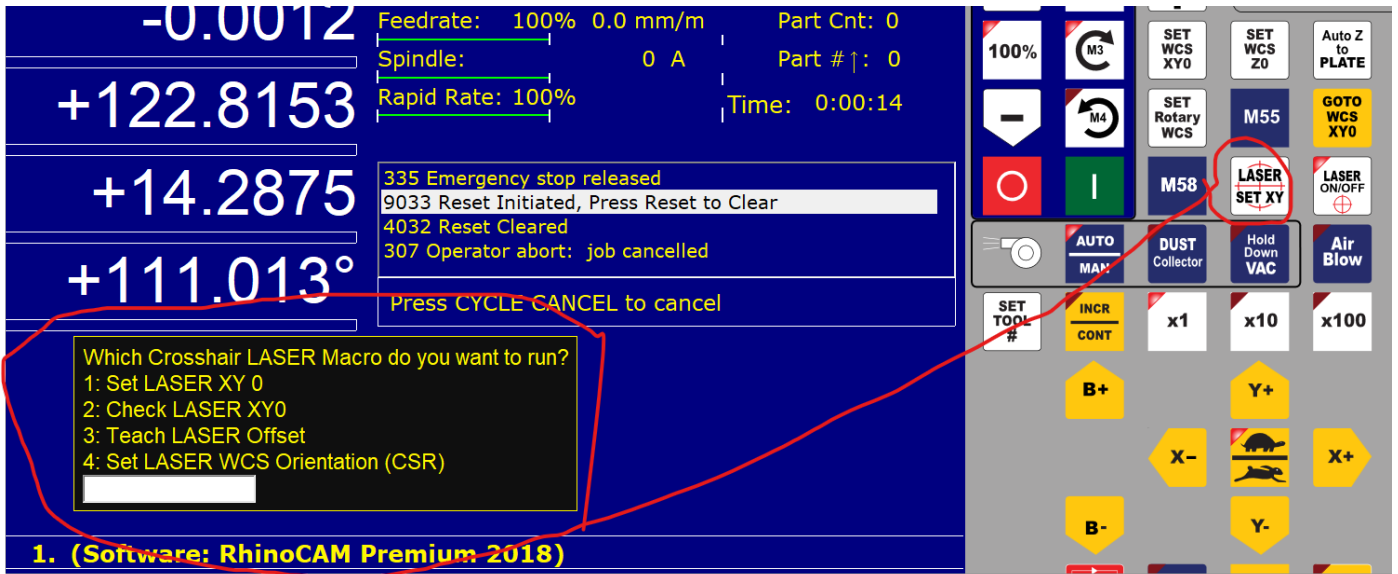

30. Router CNC12 VCP now has a "Set Tool #" button to make it easy to set the current tool number for router users that don't use the "mill style" part Z zero menu.

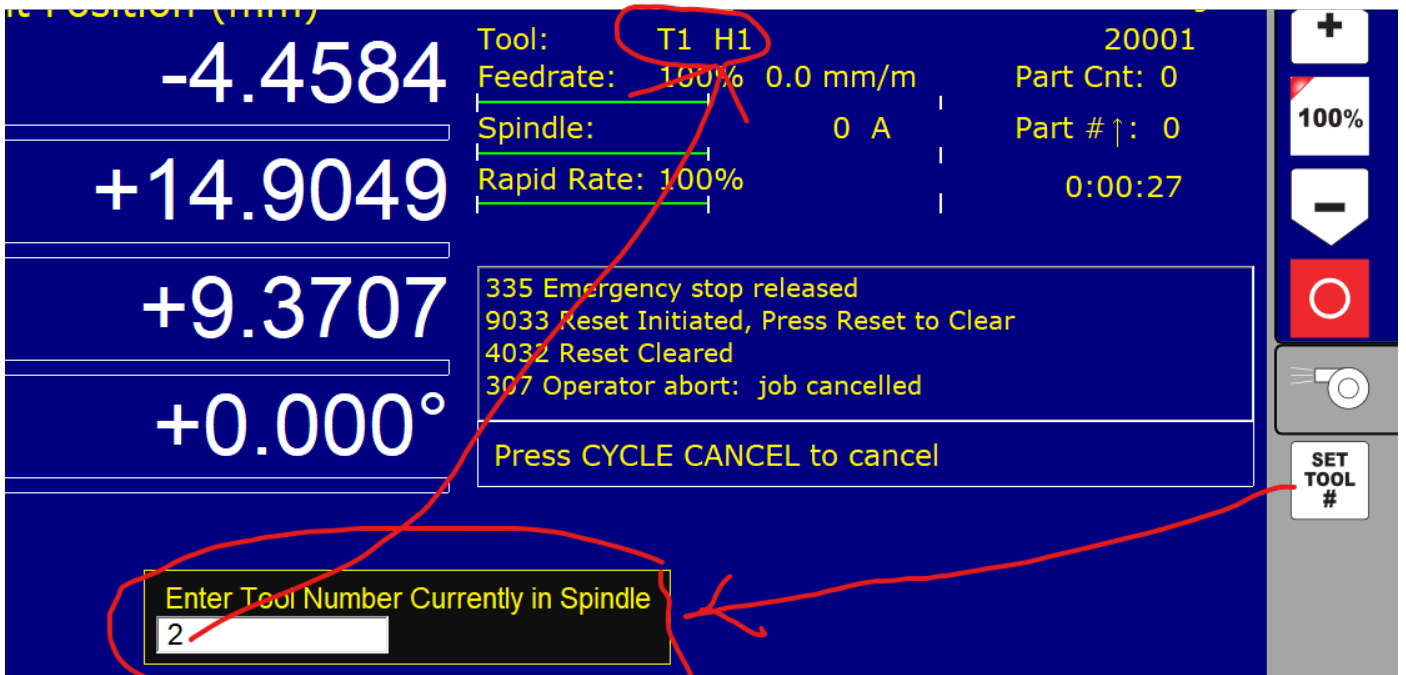

31. added plc logic for "Spindle up to Speed" input for use with M3 and M4 so now user does not have to edit the M3 or M4 macro, the M3 or M4 will automatically wait for the Spindle up to Speed input before continuing on with the G code program. A message will be displayed in the message box letting user know that CNC12 is waiting for the spindle to come up to speed before continuing on with the job.
32. Added PWM Velocity Modulation to Hickory.
33. Added "--image [IMAGE\_PATH]" as a command line argument to the VCP. This create a .png of the vcp and save it to the specified image path. The vcp will then exit. This does not require connection to CNC12 or the Centroid API.
34. Added a temporary measure to withhold the System Test requirement message if home/limit switches are not setup or a paired axis exists
35. Fixed M98 skipping a call if an L command was not specified. Related to G65 accepting L0
36. Fixed VCP text feature not parsing text for buttons
37. Added Warning message when closing the Simple PLC diagnostic tool after having forced on any output(s)
38. Consolidated Cross Hair Laser Buttons to free up a Router and Mill VCP button space for Set Rotary Zero.
39. Fixed graphic anomaly where homing direction indicator in the Wizard for the 4<sup>th</sup> axis would not stick on the selected M91/2 setting. This was a graphic only bug and did not affect the actual homing process.
40. Fixed RTG DRO distance to go position Graphic overlay anomaly for Lathes that have Turret axes being displayed as an axis.
41. Fixed G code Search bug where two tool changes would occur when searched for a line that had a macro on it which would result in double tool changes and other unexpected results.
42. Increased the CNC12 Bitmap graphics resolution to maximum, now all bitmaps (.bmp's, jpegs and .pngs) look better in CNC12 than before.
43. Added Soft Limit control to Plasma and Laser THC position so now THC will not exceed a soft travel limit.
44. Added API call "RefreshGraph" which will refresh either the rtg or regular graph screens

45. Plasma Intercon: Fixed bugs where a lead-in/out from a Circle Frame/Arc would be incorrect

46. All Centroid CNC controller boards now require a Power Cycle after a Hardware Firmware change has been made (for instance when installing a new version of CNC12 or switching from Mill to Lathe CNC12). Messaging has been added to let the user know to power cycle the Acorn/AcornSix/Hickory board after a Firmware Change and then restart CNC12.

**CNC12 firmware update complete!**  
**A hardware power cycle is required to ensure proper operation.**  
**Press any key to exit, power cycle the CNC Control board and restart CNC12**

47. Added logic to the Default M3 and M4 to support the canned Wizard definition "VFDUpToSpeed". When this input definition is used the M3 will wait for the input to be made before continuing on with the G code program.

48. Added to the Wizard Tool Touch Off device setup menu choices between the two main methods of measuring tool height offsets. Reference Tool method OR Z ref = Z home.

Tool touch Off type	Mechanical	(P405)
Input state when triggered <a href="#">*Probe Setup Documentation (PDF)</a>	Closed*	(P407)
Tool Measurement Reference Method	Z Home = Z Ref	(P003)
*Use Touch Probe as Reference Tool Note: Uses TP input when auto setting reference position with a TP instead of TT input	No	(P043)

49. Added to the Wizard Touch Probe setup menu the ability to enable/disable the new Probe Protection feature based on Tool number.

Maximum probing distance	10	(P016)
Probe Protection Enabled	Yes	(P153)
Probe Protection based on Tool Number	No	(P003)
Inhibit Spindle when Detect is on (Green)	Yes	(P416)
Display Warning to Verify that Probe or TT is functioning properly	Yes	(P410)

50. 452 Ethernet Communication Error message has been inadvertently suppressed and will not display in the CNC12 message box or logs files. Even if the board ethernet cable is completely disconnected from the CNC12. Not to worry though, there are other CNC12 ethernet communication error messages that will appear even though this main error message has been inadvertently disabled. Fixed in R17806+ (RC7) 4-29-24

51. Hickory Installer Option "Copy Manuals to Desktop" does not work. Workaround: Navigate to C:\cncx\manual to find manuals. (X ofcourse is "m" or "t" for mill/lathe) Fixed in R17806(RC7)+ 4-29-24

52. G-Code Display shows up on the Setup Menu when if a bad password was entered for Config Menu or ATC Setup is run. Fixed in R17806(RC7) + 4-29-24

53. behind the scenes Wizard logic was reversed on the "Use a Touch Probe as the reference tool" selection

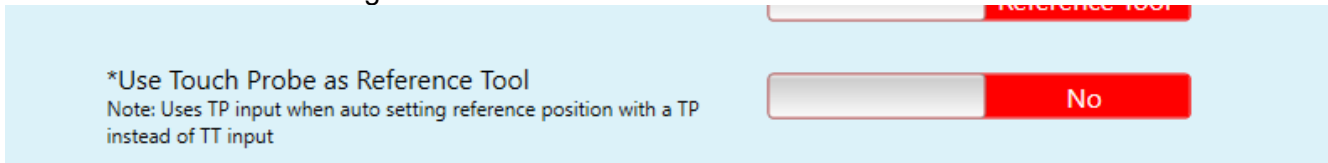

Fixed in R17806(RC7)+ 4-29-24

54. Plasma only

The VCP button "Laser Set XY" file name is incorrect.

Fixed in R17806(RC7)+ 4-29-24

(proper name is **set\_laser\_XY.cnc**)

55. Plasma only. In the Wizard selecting any of the Custom Outputs selection will cause the Wizard to crash.

Fixed in R17806+

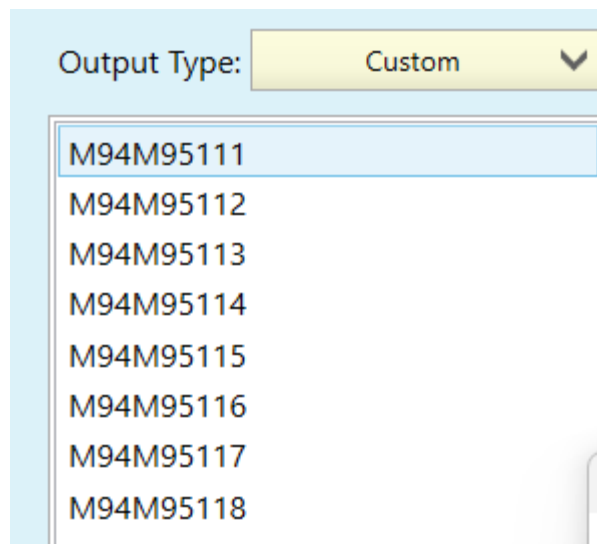

56. Improved Ethernet Communications from the PC to the BBG on Acorn which should eliminate having to go to the "half duplex" setting to pass the Communications Stress Test with some Intel Ethernet chips sets. The issue was found to be repeatable with Intel I226-V NICs. These are common in newer NUCs and the Beelink mini PC. This issue was not observed with older PCs with I218-V or I219-V NICs. Which explains why some users would have this issue and others would not.

#### v5.1 Known issues

- a.) First Install of (Hickory Lathe) will produce a pop up message with "Invalid command line argument". Currently investigating cause, it appears to only happen on our fresh installs. Workaround : Install Hickory Lathe a second time, will correct the issue seemingly indefinitely.
- b.) Using a NC TT will force the VCP to start in Slow Jog mode even if you have the VCP set to Fast mode as the default setting. It is easy to simply select fast jog at this point. So this is not a big deal, just slightly annoying. Fix is to edit PLC program and add timer on the probe/tt tripped check. That fix has already been committed in the template source file for the next version.
- c.) CNC12 parameter description for P856 is incorrect. The correct description is:

Virtual Control Panel (VCP) default Jogging mode upon power up.

0 = slow/incremental, 1 = slow/continuous, 2 = fast/incremental, 3 = fast/continuous

- Requires a CNC Control Board Power cycle to take affect.

- Set by the Wizard

and fyi... These New tags soon will be shipping attached to every Centroid CNC control main board.

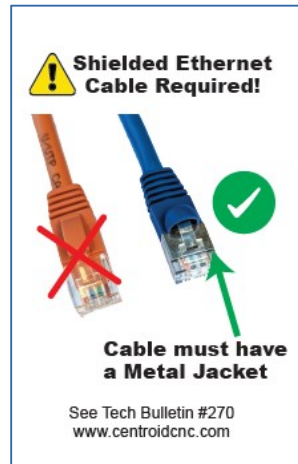

1. Acorn and AcornSix: Separate Rapid Override control functionality has been added Acorn and AcornSix. This feature is now by active by default on any CNC12 installation for Acorn and AcornSix. Rapid Override control is done with the VCP (virtual control panel) the v5.08 VCP has both controls for Feedrate and Rapid Rate override.

#### Rapid Override Notes:

- Legacy functionality (having the Rapid and Feedrate override on the same control knob like it has been for many years) has been retained for those that do not want to use this new separate Rapid and Feed rate override control.

- This new separate rapid override control feature is will work with the Oak/Allin1DC/MPU11/Hickory platforms but requires PLC program and or VCP editing to enabled this feature. In a future release of CNC12 the included Centroid provided stock PLC programs and VCP will have this feature pre-programmed.

2. Acorn and AcornSix new VCP skins: Included with CNC12 are new Centroid 'stock' Rapid Override VCP skins which have the new separate Rapid Override control functionality ready to run in the VCP skins for Acorn and AcornSix.

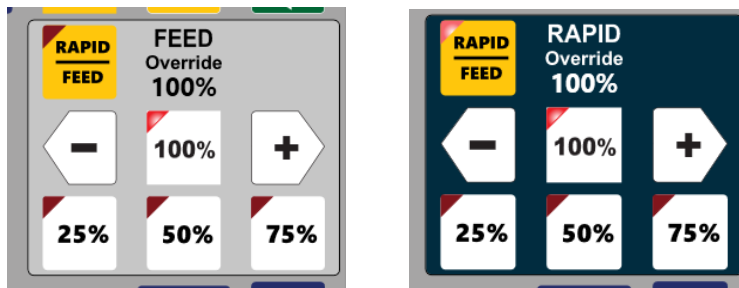

These skins will have the word "rapid" in the file name.

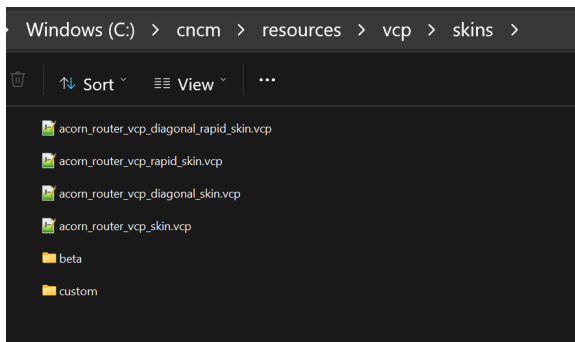

Stock VCP skins without this feature are also still included so users can use the old Centroid VCP skins if desired, these filenames do not have the word "rapid" in them.

#### Notes:

a.) Custom VCP's can be edited to include the new separate rapid override controls if desired. To do this, simply copy over the corresponding code from any of the Centroid stock VCP 'rapid' skins and corresponding button folders and set parameter 264 = 3 and it is required to add the corresponding PLC code to the PLC program if you are using a Custom PLC program.

b.) Any custom Acorn/AcornSix PLC programs will continue to work as they did before and will not separate the rapid and feedrate controls. Even if user sets Parameter 264 =1 or 3 without updating the custom PLC program CNC12 will run as normal and will not separate the rapid and feedrate controls aka the old way of doing things.

- Software implemented for Future USB Operator Control Panel products: such as operators physical knob control of Rapid Override, Feedrate Override, and Spindle Speed Override via USB as well as Cycle Start, Cycle Cancel, Tool Check, Feed Hold buttons and other future uses of USB input for CNC control use. This software and hardware technology frees up inputs on the control hardware and allows operator controls such as digital encoder knobs without requiring use of any analog inputs (like the old potentiometer type analog input) This new tech is designed to be compatible with all CNC controller hardware. (Acorn, AcornSix, Hickory, Allin1DC, Oak, and MPU11). Parameter 496 tells CNC12 which com port to look at for the new Centroid USB control panel. Simply enter the com port number (you can look it up with Windows Device manager) For example if windows device manager shows the new control panel connected to COM4 enter a "4" into Parameter 496 and reboot CNC12. Future version of CNC12 will auto recognize the USB port, for now you must set it manually to 'turn on' the USB control panel hardware.
- To make things easy for Wizard users, a Centroid 'stock' VCP skins selector has been added as a drop down box in VCP Preferences folder for Acorn and AcornSix.

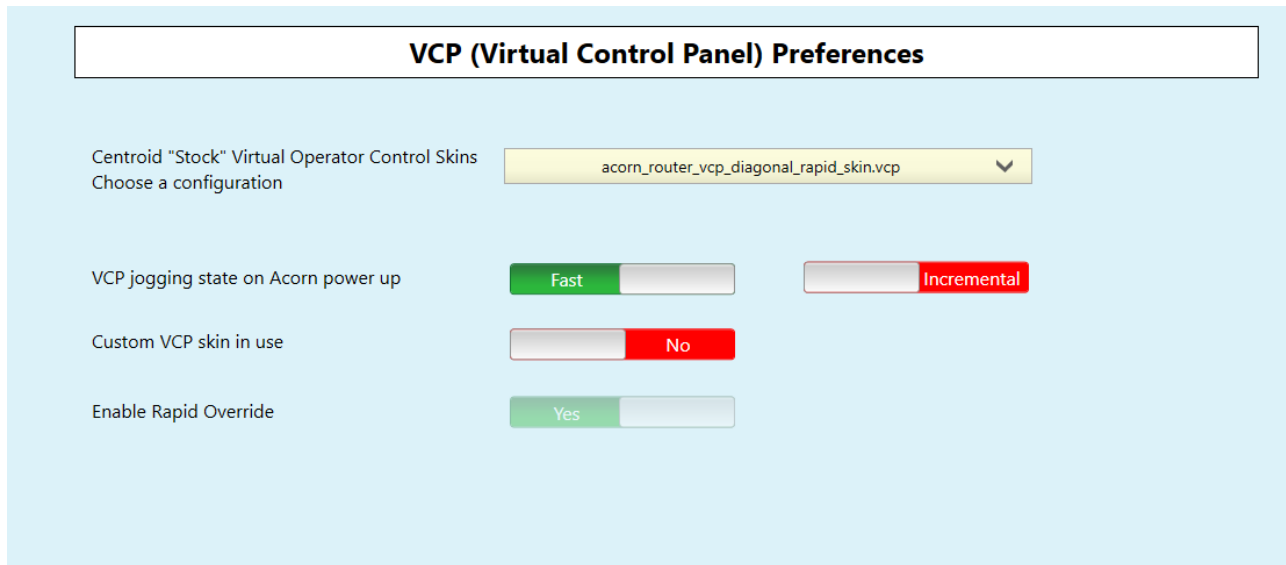

Note: Any .vcp file located in the c:\cncm\resources\vcp\skins folder will appear in this Wizard drop down box. The Wizard reads the contents of this folder and displays any .vcp files in this location as a selection in the drop down box.

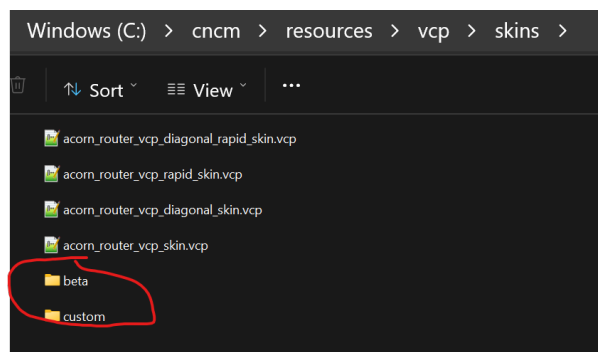
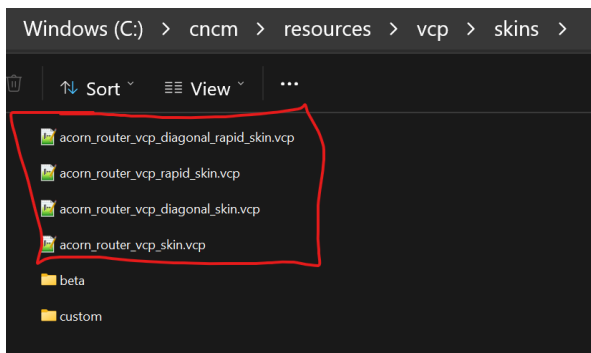

Two new folders also appear in the cncm\resources\vcp\skins folder. "beta" and "custom"  
 - Beta = new skins ready for beta testing  
 - Custom = a place holder for any skin that you don't want to show up in the Wizard Skin Selection drop down box.

5. VCP: Added a "Switching" functionality in the VCP code where buttons, borders, and images can be swapped out when user presses a button. This feature has the ability to have different buttons, borders, and images defined to occupy the same space. Each button, border, and image (referred to collectively henceforth as an 'object') requires a group to be defined, define the group in the .vcp xml file

Groups for borders and images are defined via a child node, example:

```
<border>
  <group>group_name</group>
</border>
```

```
<image>
  <group>group_name</group>
</image>
```

Groups for buttons are defined via an attribute

```
<button row="Y" column="X" group="group_name"></button>
```

Any border, button or image can be defined as a group by simply adding the child node into the button/border/image node in the skin.VCP xml file.

Examples of proper use of these tools can be found in the new Centroid 'stock' (centroid provided) VCP skins with the word "rapid" in the name.

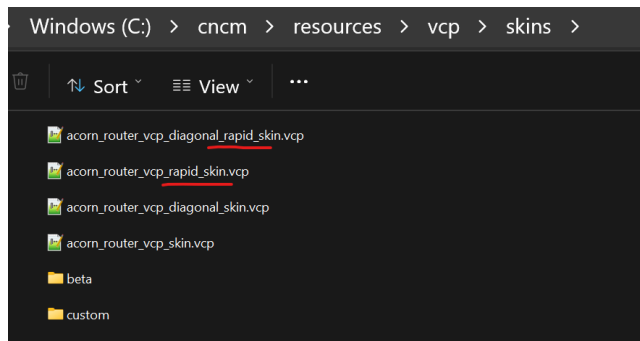

the sample code below is from acorn\_router\_vcp\_skin.vcp showing how to add a border to a group.

```
<border>
  <column_span>3</column_span>
  <column_start>4</column_start>
  <fill>#012c3f</fill>
  <row_span>3</row_span>
  <row_start>11</row_start>
  <outline_color>#000000</outline_color>
  <outline_thickness>1</outline_thickness>
  <group>rapid_group</group>
</border>
```

Adding this child node within <border> and </border> adds this particular border to a group called "rapid\_group" this group can then be switched on/off along with the button press.

Multiple borders, images and buttons can be added to any given group.  
 acorn\_router\_vcp\_skin.vcp has examples of this as well, below you see the border for rapid override and the % value of the rapid override being included a the group call "rapid\_group".

```

<border>
  <column_span>3</column_span>
  <column_start>4</column_start>
  <fill>#012c3f</fill>
  <row_span>3</row_span>
  <row_start>11</row_start>
  <outline_color>#000000</outline_color>
  <outline_thickness>1</outline_thickness>
  <group>rapid_group</group>
</border>
<border>
  <column_span>3</column_span>
  <column_start>4</column_start>
  <fill>Transparent</fill>
  <row_span>1</row_span>
  <row_start>11</row_start>
  <outline_color>Transparent</outline_color>
  <outline_thickness>1</outline_thickness>
  <plc_word>
<number>58</number>
<color>#ffffff</color>
<fontsize>22</fontsize>
    <font>Sergio UI</font>
    <fontstyle>bold</fontstyle>
    <verticalalignment>bottom</verticalalignment>
    <horizontalalignment>center</horizontalalignment>
    <marginbottom>-5</marginbottom>
    <percentage>>true</percentage>
  </plc_word>
  <group>rapid_group</group>
</border>

```



This way when the user presses the Rapid/Feed button on the VCP the VCP switches from Rapid to Feedrate Override controls, and vs verse. Notice the border,background and PLC words (the value the user has Feedrate and Rapid rate set to) switch.

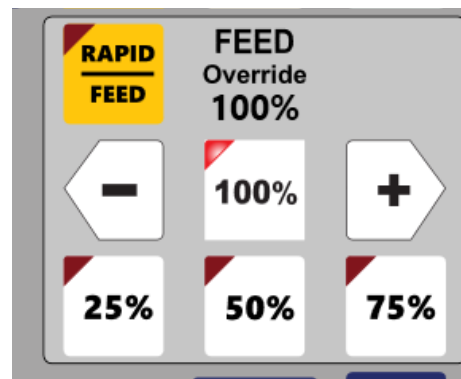
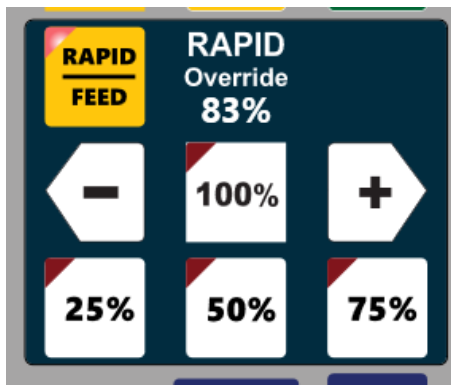

Once groups are defined in the .VCP skin. What to do with those groups is defined in the button .XML itself.

Example code from the new button called “rapid\_feed.xml” file that is using this feature:

```
<vcp_button>
  <switch>
    <switch_on>
      <remove>feed_group</remove>
      <remove>feed_button_group</remove>
      <add>rapid_group</add>
      <image_on>rapid_feed_lit.svg</image_on>
    </switch_on>
    <switch_off>
      <remove>rapid_group</remove>
      <add>feed_group</add>
      <add>feed_button_group</add>
      <image_off>rapid_feed.svg</image_off>
    </switch_off>
    <remove>linked_group</remove>
    <add>unlinked_group</add>
  </switch>
</vcp_button>
```

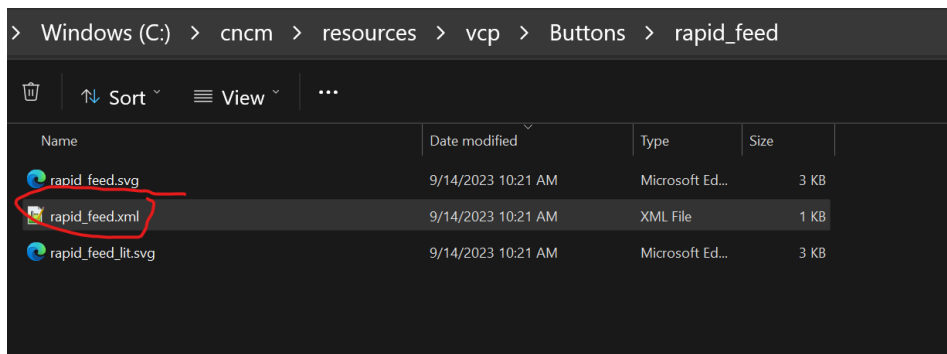

Note: For start up, a node must be inserted into the skin (.vcp file) to hide all of the groups that are unwanted at start up.

If this is not done, all objects will be visible from the beginning resulting in a mess as seen below.

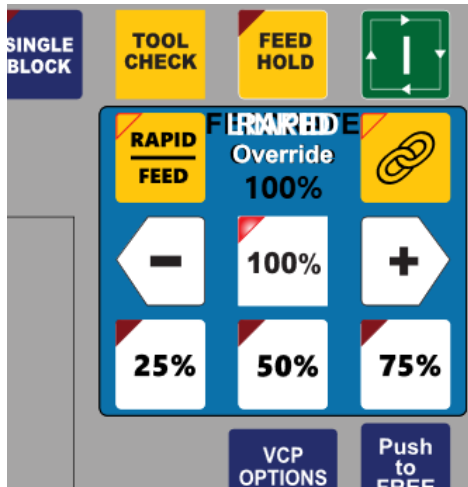

Using our example file `acorn_router_vcp_skin.vcp` you can find an example of hiding the rapid group on start up beginning on line 121.

```
117         <opacity>100</opacity>
118         <outline_color>#ffffff</outline_color>
119     </on_hover>
120
121     <hide_group>
122         <group>rapid_group</group>
123     </hide_group>
124
125     <button row="1" column="1">spindle_plus</button>
126     <button row="1" column="2">spindle_auto_man</button>
```

The rapid group is being hidden on start up since the VCP defaults to Feedrate Override controls being displayed on startup so we don't want the Rapid Override value, border or background color to be displayed on startup.

Convention to hide on start up is simply:

```
<hideGroup>
    <group>group_name_1</group>
    <group>group_name_2</group>
</hideGroup>
```

The `hideGroup` node has no limit on how many groups can be hidden. While there is no limit on how many objects can be added to the VCP, it is important to note that performance may suffer as more objects are added. (We would estimate that decreased performance would start to become visible at approximately 1000 objects)

6. VCP Feature: Added the <run> ability to the VCP where a VCP button can now be set to run either a single line of G-code or a Macro immediately, without the need for cycle start..

run a line of g-code via <line>

or

run a macro via <macro>

Insert these commands directly into the button .xml file

To run run a line of g-code with a VCP button:

```
<run>  
  <line>G0 X0 Y0</line>  
</run>
```

To run a macro directly with a VCP button, Specify path and filename:

```
<run>  
  <macro>C:\cncm\ncfiles\myMacro.cnc</macro>  
</run>
```

Notes:

- a.) Button will only work when being run from the main menu of cnc12.
- b.) Both a macro and a g code line cannot be run at the same time.

**What not to do example**

```
<run>  
  <line>G0 X0 Y0</line>  
  <line>G1 X1 Y1</line>  
</run>
```

*When pressing the button the first line (G0X0Y0) would be run and the second line would be ignored. **In this case, the two lines should be put into a macro and the macro option used.***

**What not to do 2<sup>nd</sup> example**

```
<run>  
  <line>G0 X0 Y0</line>  
  <macro>C:\cncm\ncfiles\myMacro.cnc</macro>  
</run>
```

*When pressing the button the first line (G0X0Y0) would be ignored completely and the macro would be run instead.*

**In this case, the first line should be included in the macro.**

7. VCP: We added the ability to draw text onto the VCP without the need of an image.

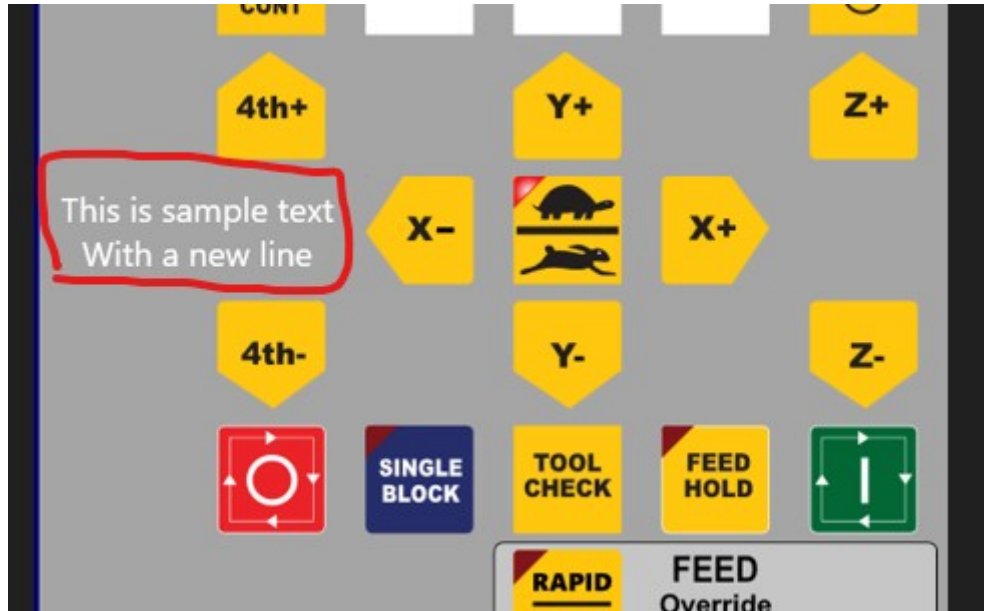

Example code from the skin.vcp file for the image above.

```
<border>
  <column_span>2</column_span>
  <column_start>1</column_start>
  <fill>Transparent</fill>
  <row_span>1</row_span>
  <row_start>8</row_start>
  <text>
    <content>This is sample text&#13;With a new line</content>
    <fontsize>20</fontsize>
    <color>#ffffff</color>
    <font>Segoe UI</font>
    <horizontalalignment>center</horizontalalignment>
    <verticalalignment>center</verticalalignment>
  </text>
</border>
```

Note:

- &#13; = Carriage Return (adds a new line)

- This feature functions in a similar fashion to the VCP feature called plc\_word.

See v5.0 release notes for more details on page 13.

[https://www.centroidcnc.com/centroid\\_diy/downloads/centroid\\_cnc12\\_download/centroid\\_cnc12\\_v5.0\\_release\\_notes.pdf](https://www.centroidcnc.com/centroid_diy/downloads/centroid_cnc12_download/centroid_cnc12_v5.0_release_notes.pdf)

8. VCP image paths are now case **ins**ensitive allowing a more 'forgiving' UX when creating custom VCP skins.
9. Wizard: Added "LaserCooling\_Fan" output to the Output Definitions menu. This Output will automatically turn on with a M37 (laser on) and turn off with a M38 (laser off)

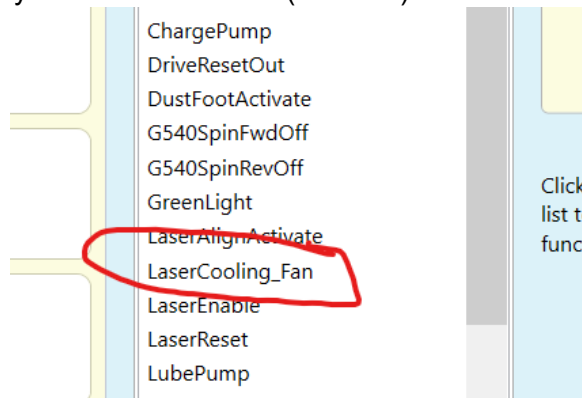

10. Added Laser Cooling Fan OFF delay timer which keeps the fan running the after laser is turned off (M38), by a set mount of time specified by the user.

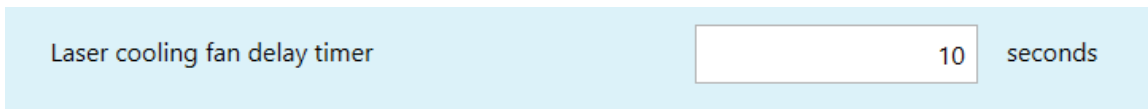

11. Updated the Acorn/AcornSix Wizard PLC logic for SpindleCoolingFan output. Now the spindle cooling fan output is automatically disabled when a M37 (laser on) is issued.  
Note: The user specified SpindleCoolingFan delay timer will still be active even after an M37. For example: if you have the spindle cooling fan delay time set to 10 seconds, when the M37 is executed by CNC12 the spindle cooling fan will still run for 10 seconds and then turn off.
12. Feature added to all Pro License: Added all 18 WCS positions to the Pro License software level for Mill, Router, Lathe, and Plasma.
13. Hickory: Added support for Leadshine EL7 and EL8 EtherCAT servo drives for Hickory CNC controller.
14. Installer will now rename the cncm/cnct directory to be the backup instead of making a copy of it. This results in faster install times and doesn't change the dates of the files contained in the cnct/cncm directories which makes updating easier. Along with this we added a self closing message box to the installer informing the user that a backup is being created during the install process.
15. Acorn/AcornSix: Fixed WMPG not moving the slaved axis after homing prior to jogging the paired axes through any other means.
16. Fixed graphics anomaly issue bug in probing menus where instructions would clip into the diagrams on lower resolutions
17. Added default load path to path.ini file for F2 – Load. This allows user to specify which folder to open by default when pressing F2 Load.
18. Fixed issue where the "Feedrate:" in the status window did not change to white text on a red background when rapid override is off.

19. Fixed issue where the display of PID output was not working in that it only showed 0 or OFF.
20. Fixed bug where DRO display would clip when more than three axes were visible on lower screen resolutions
21. AcornSix Wizard: Removed PWMOut assignment when selecting JTech Radio buttons. Since AcornSix has its own dedicated PWM Out header connections this choice is unnecessary and could cause confusion.
22. Fixed Plasma Restart Mode adding duplicate block numbers causing job not restarting properly
23. Lathe Turret: Removed hard coded distance. To allow users to adjust Turret movement amounts easily. Added Distance to travel past and distance to travel behind in Axis Driven Turret ATC type. Parameters 853 and 854 respectively.
24. Color Picker: Added a color option for Keyboard Jogging Active text and changed the default color for this for more contrast.
25. Fixed a bug when "Rehome after estop" option is set, estop is hit and the software is restarted without ever rehomeing, the machine would not require a rehome
26. Fixed bug where homing message would display on top of g-code preview if "Rehome after estop" option was set
27. Lathe: moved exit key from F9 to F7 to prevent accidental exiting when using F10 Shut\Down.
28. Fixed a bug where PLC words on the vcp will display their last known value after losing connection with the skinning api
29. Fixed a bug in the lathe run time graphics where the z axis would appear multiple times on first launch and then disappear completely every subsequent job run
30. Fixed a bug where large files would clip while graphing
31. Oak/Allin1DC/Hickory: Added remaining number of days information for a trial license to the report.txt
32. The Skinning API functions GetMachineParameterValue and SetMachineParameter have been modified to allow the reading/writing of user variables 29000-34999 in any job state and in any menu
33. Wizard will not force a Legacy VCP skin if the plc is newer than vcp 2.0 (Feb 11, 2020)
34. Fixed a rare intermittent issue where a lost or dropped UDP packet could result in a digitizing move appearing to lock up. In such cases, pressing a key on the keyboard (other than ESC or space bar) would result in the continuation of the digitizing.
35. Restored "Backup Files" and "Restore Files" to the User Maintenance menu.  
Note this was previously removed in v.5.00, surprisingly some users are still using this old DOS like feature so we restored this functionality.
36. Wizard: Fixed bug where parm 44 was set to parm 11 if ToolTouchDetect input wasn't defined
37. Fixed a situation where VCP was not terminating fully when closed through the windows taskbar
38. Updated the Acorn/AcornSix Wizard generated M6 macro for ATC tool changes to fix this bug.  
<https://centroidcncforum.com/viewtopic.php?f=60&t=9250>

39. ALLIN1DC Lathe ATC Hardinge PLC: Fixed issue with Jogging 1st and 2nd axis in the PLC program.
40. Fixed issue in AcornSix, Oak, ALLIN1DC, and Hickory PLC's that caused WMPG Macro buttons 1-4 to be unresponsive after pressing Macro 4 button.
41. Wizard now explicitly sets probe and tool touch parameters to both look at the probe inputs if tool touch inputs are not set up.
42. Fixed Paired axis selection slider from AcornSix was inadvertently showing up in Acorn Wizard
43. Added Windows taskbar state information to the report.txt file
44. Added DRO display unit control to the wizard menu CNC Control Preferences. This changes JUST THE DRO DISPLAY units and not the machine tool units. In other words, the machine could be operating in millimeters and running g code in mm but the DRO display would be displaying position in Inches. The unit controls for this and machine units are in the CNC12 configuration menu.(F1 setup, F3 config, F1Contrl)
45. Added skinning calls SetDroImperialUnits and SetDroMetricUnits which set the dro units independently of the machine units
46. Added Skinning Call "IsAPIRestricted" which checks the state of CNC12 and returns true/false if there are any restrictions imposed on the API. Note, all skinning calls have different criteria for when they can be called. This call collects the more common criteria together.
47. Fixed a bug where restore report would fail if a directory for a file didn't exist. Restore report will now create that directory
48. Plasma Intercon: Improved graphing performance with an all new graphics engine.
49. Plasma Intercon: Fixed a bug where importing a DXF could cause duplicate events to appear
50. Plasma Intercon: Fixed a bug where using DXF presets could incorrectly post the part
51. Plasma Intercon: Fixed a bug where moving the origin would cause some Arc events to calculate incorrectly
52. CNC12 Legacy Load menu: Fixed wxwidgets crash when accessing files in the root directory in Windows thru CNC12. When P4=5 "cnc12 style of loading a file" crash would have occurred when attempting to load a file in the [c:\](#)
53. Wizard: Fixed a bug in the Axis Configuration screen where if the last accepted fast and slow jog rates exceeded the max rate, the Wizard will instead default back to the max rate available
54. CNC12: Fixed issue where the load meters were not working for an ACDC drive.
55. Added Command Line Arguments to the installer for OEM use
56. Improved start up ethernet packet handling reduces false alarm error messages on cnc12 start up.
57. Improved tangential knife support for when CSR is active with Tknife via machine parameters 580 which Identifies which axis is the Tangential Knife Axis and 581 which allows user to flip the sign of the Tknife rotation.

P580 Identifies which axis is the Tangential Knife Axis. This parameter is bit wise.

Examples: If Axis 1 is the Tknife axis then P580 = 1 ( $2^0$ ), Axis 2 = 2 ( $2^1$ ), Axis 3 = 4 ( $2^2$ ), etc.). P580 is what enables the axis as a Tangential knife so that CSR calculations are applied to this axis when active.

P581 "Tangential Knife Direction" (allows sign change to define which rotation CW or CCW is positive. Industry standard is CCW is positive. P581 default value is 0 = CCW is positive for any Tknife axis. This parameter exist only to flip the sign of the direction of the Tknife typically flipping the sign is not necessary, review axis setup (wiring and configuration) before adjusting this parameter. Determining Tknife CW or CCW rotation is viewed from above looking down.

To and value of bit per axis reverses sign to CW positive, so if axis 3 was Tknife add 4) to allow the knife angle to be adjusted according to any G68 rotation and/or WCS CSR rotation in effect.

Tangential Knife support: Since Tknife is actually treated as a linear axis we added a bit to "Display a Linear axis as a Rotary axis" to the CNC12 Axis properties parameters. This bit is Bit 17 (+131072) and when added will display a linear axis as degrees on the DRO, Machine coordinates display and the WMPG display, etc. Axis parameters are 91-94 for axis 1-4 and P166-169 for axis 5-8. Typical default value for a Tknife axis as the 3<sup>rd</sup> axis P93 = 131072

Note: For Acorn and AcornSix Tangential Knife Users. The Acorn Wizard "takes care" of these Tangential Knife parameter settings (above) for you so, no action by users is needed (besides configuring the Tknife axis with the Wizard).

58. Improved startup Ethernet packet handling removes the occurrence of random false communication error messages on CNC12 startup after a firmware update.
59. WMPG will now properly set Fast/Slow Jog rate when X10 or X100 is selected and Z-X100Lockout Feature is enabled.
60. Plasma Intercon: Improved dxf/svg import and determination of safe lead-in/out placements
61. Plasma Intercon: Lead-outs now support over cutting onto the beginning cut of a part
62. Plasma Intercon: Lead-in and Lead-out are now controlled separately
63. MPU will now reboot if a firmware update fails to install the first time, preventing a communication error message on startup
64. Fixed bug where the mini dro and mini machine coordinates were not removed when returning to the CSR menu from MDI causing graphical bugs in other menus
65. Defaulted parameter 3 to a value of 6 for Acorn and AcornSix router installs to set Zref = Z home which is the most common Router tool measurement method (i.e. not using a reference tool, all tool lengths are measured from Z home to the same position in space.)
66. Added check to the installer to close any Windows Explorer Image (single running instance) that has a lock on any directory running out of cncm or cnc12. This is intended to break hidden locks caused by the Windows system preventing the renaming (backup) of the current cnc12 install
67. Fixed bug where "Increment Mode" was displayed incorrectly and inaccurately in the WCS origin menu when cycling through pages.

68. Fixed a probe state indicator graphic anomaly where the graphic became skewed/disproportional (this has/had no effect on any operation, this was purely a display graphic issue where the probe state image was being stuffed into a window not using the same proportions as the graphic itself)
69. Parm 56, bit 0 (add 1) will apply an averaging filter to the feedrate display (does not affect the actual rate)
70. Wizard: Fixed an issue with the Wizard Generated rack mount tool change macro when "Maintain a tool library" is selected for Rack Mount Bins. Problem was caused by "lookahead" assigning the put back bin before CNC12 fully has a chance to update the bin. Simple change to the mfunc6.mac was all that is needed to prevent lookahead from parsing the Tool Change macro.
71. Plasma: Added a folder of Material Profiles specific to the Hypertherm PowerMax 45XP cutter.
72. Added the letters "sample\_" to the filenames of the sample g-code and intercon files included with the CNC12 installer so its easy to identify them as samples. Added sample Euclid CNC Machine test g code programs, one generated by MasterCam and the other by Intercon. The MasterCam generated one has use specifics in the comments within the g code file itself, edit as needed. The Intercon (.icn) file is also included for those that wish to modify the Intercon Euclid block test program to their specific needs as well. Either one does the same job in the end which is to determine machine accuracy and proper setup during final commissioning of a milling machine (or router).
73. Removed an old warning message that seems to be not too useful. The message "MPG moving too fast" will no longer appear if a user spins the MPG wheel really fast. No changes in any action or motion this change is simply is removing the message that would appear in the CNC12 message box.
74. PC Tuner: The NCnetic Notepad++ Gcode viewer/editor plugin is now included with the CNC12 installer. The PC Tuner now will install this nice plugin for use with Notepad++
75. Fixed bug where Oak/Allin1DC/Hickory/MPU11 systems would not update the distance to go DRO readout for a slaved axis if the slaved axis had a label.
76. Fixed bug where M200 wasn't displaying the formatted message for AcornSix
77. Fixed bug where Lathe RTG menu DRO showed X coordinates in Z location and vice versa
78. Fixed bug where two outputs could be assigned to OUT2 in the Wizard if PWM was enabled
79. Updated the "System Test Not Passed" message on main screen with graphics and hyperlink to TB 327.
80. Fixed bug where G-Code display would not update with a newly posted Intercon job
81. Created the Hickory absolute encoder paired axis gantry alignment/squaring procedure document.
82. Added a new bit to parameter 1 (Add16) that will flips the X Jog direction.
83. Laser: fixed a bug where the laser would stay on during a Feed Hold and Tool Check.
84. Secondary backup option added to installer so if renaming the cncm/cnct directory fails it will copy it.
85. Dynamic conversion between metric and imperial units added to the plasma profile manager. Previous version relied on the metric or imperial install version and would not convert if units were switched after install.

- 86. Issue with Plasma restart mode not rounding floating point numbers.
- 87. PC Tuner installation removed from the CNC12 Installer, PC Tuner is available as a stand alone download.
- 88. The v5.08 release will be the last 32 bit version of CNC12.

A 64 bit version of v5.08 will also be published at the same time for 64 bit testing.

Notes:

- Looking to the future, the next version of CNC12 will be released as 64 bit only version.
- In the future all 3<sup>rd</sup> party apps will be required to be compiled as a 64 bit program to run with CNC12 starting with the next major release (v5.20).
- If you are currently using a custom App that makes use of the Centroid APi (formerly known as “Skinning”) tools, Use the 32 bit version of CNC12 v5.08 so you won’t have to make any changes to the custom/3rd party App.

Centroid CNC12 v5.06 Release notes. 7-31-23  
Acorn, AcornSix, Oak, Allin1DC, Hickory.  
Mill, Router, Lathe, Plasma

(Download v5.06 here:

[https://www.centroidcnc.com/centroid\\_diy/centroid\\_cnc\\_software\\_downloads.html](https://www.centroidcnc.com/centroid_diy/centroid_cnc_software_downloads.html))

- 1.) Plasma THC now keeps track of the Z machine coordinate home position when switching in and out of THC mode.
- 2.) Plasma THC WCS Z position drift bug fixed, (related to item #1)
- 3.) Fixed bug where CNC12 function keys would disappear after exiting Restart Mode in Plasma
- 4.) Fixed bug in Restart Mode where moving backwards on the first event would consider the starting point at (0,0) rather than where the torch head currently is at
- 5.) Plasma Intercon: When moving the start point in a dxf or svg group, the graph will remain at the scale in which it is positioned
- 6.) Plasma Intercon: Fixed bug where lead out length value was being applied to a Lead In event causing a tail on DXF imports.
- 7.) Plasma Intercon: Added DXF Gap Tolerance Upper and Lower Bounds to control the vector that is added when bridging gaps between lines, arcs, and splines
- 8.) Plasma Intercon: Removed drag\drop native feature from textboxes
- 9.) Plasma: Added Scribe support in the Wizard with supporting CNC12 Parameters. Added parameters 562, 563, and 564 for Scribe X Offset, Scribe Y Offset, and Scribe Delay respectively. Wizard page was created to setup Scribe in Plasma which writes to these parameters.
- 10.) Offline Intercon/CNC12 emulator: Fixed crash when using Emulator software and accessing motor config screen or creating a report
- 11.) Lathe VCP: Added optional diagonal jog button VCP skin.
- 12.) AcornSix (and also future Hickory Wizard) and VCP: Wizard will now automatically add 5th and 6th axes jog buttons to the VCP using the drive letters assigned in the configuration menu. Note: If a diagonal skin is being used, Lathe won't automatically add 5th and 6th axes and Mill/Router won't automatically add the 6th axis, in these cases it is up to the user to hand edit the VCP.
- 13.) Acorn,AcornSix (and also future Hickory Wizard): Increased Rackmount bin count to 100. Bin setup table automatically adjusts to bin count entered by user as well.
- 14.) Rotary Axes: Added bit 16 (+65536) to the axis property parameters to denote an axis that is a rotary but the motor revs are configured in units of revolutions (instead of degrees). (Max rate should be set in RPM). With this bit set, the rotary axis can be programmed in degrees as the conversion to revolutions is handled internally. The DRO is displayed in degrees. This is in anticipation of an upcoming Wizard Rotary Axes setup page.
- 15.) CNC12: MDI phantom character bug fix attempt to solve intermittent phantom characters from appearing in the MDI history area.

*documents/cnc12\_v5.06/cnc12\_v5.06\_release\_notes.odt*

16.) Plasma Intercon: Added a "MoveOrigin" feature under Edit>Move Origin that allows the user to set a new origin point

17.) Plasma Intercon: Reworked the group feature to be able to add lead-in/out to frames and dxf/svg imports easily

18.) Plasma Intercon: Added "% of Profile Feedrate" option to the grouping menu

19.) Added "Tangential Knife" option to "Linear Or Rotary" selection in the Wizard Axis Configuration Menu in anticipation of continued T-knife feature development

20.) Updated Aux 13 and 14 skin events in the button xml file to match the updated numbers. These updates were inadvertently omitted.

NOTE: In v5.04 In order to unify Skin Event numbers for the VCP buttons across all platforms and to be compatible with the hard operators control panel a few VCP button skin event numbers in the Acorn VCP were updated and aux 13 and 14 got left out. \_

The instructions below are for only users that have a custom VCP.

If you are installing a fresh install of v5.06+ you don't have to do anything in this regard.

Users with custom VCP buttons that previously Modified Aux 13 and Aux14 will need to edit the button XML and update the skin number being used.

SKIN\_EVENT\_66 and SKIN\_EVENT\_67 are for VacOn and LimitDefeat.

Aux 13 and Aux14 are SKIN\_EVENT\_24 and 25.

User that have previously used SKIN\_EVENT\_66, should make it 24 and if they used 67 they should now use 25 going forward in V5.06.

This was a one time change to Acorn so that its skin\_events matched up with Acornsix, OAK, ALlin1DC, Hickory, MPU11 so the VCP matches up with the physical operators control panel in those cases

We don't expect to have to swap any SKIN\_EVENTS numbers again like this in the future since now the skin event numbers are the same across all platforms.

21.) Fixed Load Meter not displaying in DRO for Oak, Allin1DC, Hickory, MPU11

22.) no longer require the regional settings of the computer to be set to "English (United States)". This check has been removed from the installer.

23.) Plasma Intercon: Added extra Lead-In/Out points for DXF and SVG imports

## Centroid CNC12 v5.04 Release notes 6-14-23

(Download v5.04 here:

[https://www.centroidcnc.com/centroid\\_diy/centroid\\_cnc\\_software\\_downloads.html](https://www.centroidcnc.com/centroid_diy/centroid_cnc_software_downloads.html))

- 1.) Fixed Acorn Limit Switch defeat button functionality. (skin event number in the button xml was in inadvertently not updated in previous version v5.0/v5.02)
- 2.) Fixed Oak/Allin1DC/MPU11/Hickory VCP Aux 13-16 (the controlling CNC12 parameters were off by one) which were incorrectly configured.
- 3.) Fixed Acorn VCP button Mill Vac On/Off skin event number (skin event number in the button xml was inadvertently not updated in previous versions v5.0 & v5.02 )
- 4.) Added an all new DXF import "engine" for Plasma Intercon DXF import feature. Now the new DXF import supports a wider variety of complex arcs commonly generated by graphic art programs.
- 5.) Some Color picker additions the Plasma restart graphical menu. blue, red, and purple dots which represent the pick up point, jog off point, and interrupt point
- 6.) In the Utility menu "Create Report" now copies the Wizard generated Acorn/AcornSix ATC macros to the Report.zip file.
- 7.) Updated Skin call "GetMachineType" it will now also return "emulator" for offline use.
- 8.) In Acorn and AcornSix it is now possible to mix and match HomeAll with other HomeOk inputs for example:

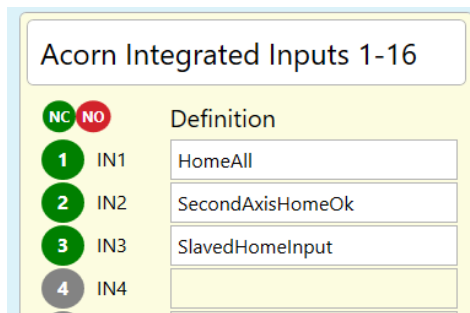

and the Wizard generated home program will work using all of the defined homeok inputs in addition to HomeAll.

- 9.) Added auto detection skin call so AcornSix Wizard will auto detect the AcornSix Encoder Expansion Board. "IsENCEXP12Connected"
- 10.) Fixed M1 functionality which was broken in AcornSix, Oak, Allin1DC, Hickory, MPU11.
- 11.) Fixed M0 jogging which was enabled regardless of what Parameter 10 was set to.
- 12.) Moved the TT Fixed location from the ATC menu to the Tool Touch menu in the wizard.
- 13.) Added WCS Lockout Parameter to Lathe (parameter 426). WCS Lockout was previously only available in Mill/Router/Plasma and was controlled by parameter 45

14.) Added easy control of ATC fork engage and disengage speed in the Wizard ATC setup page for Acorn and AcornSix

**ATC Setup**

ATC Type: RackMount (dropdown) \* Requires a Pro, Ultimate, or Ultimate Plus License

Custom Tool Change Macro (M6) in use: No (toggle)

Number of Pockets: 0 (input)

Machine Position Z Height Flyover: 0 (input)

Tool Rack Holding Configuration: Hole (toggle)

**Fork Engage/Disengage Speed: 50 (input)**

Choose Rack Mount Tool Length Method

- Measure Tool Length after each Tool change at a [Fixed Tool Touch Off](#) position
- Measure Tool Length after each Tool change using Surface Plate (operator will be prompted)
- Maintain Tool Length Offset Library (requires accurate homing) and do not measure tool length with every tool change

	X Position	Y Position	Distance and Direction to Clear	Clearing Axis	Z Height
Pocket 1 (Bin 1)	0	0	0	1	0
Pocket 2 (Bin 2)	0	0	0	1	0

15.) Pro Plasma License now includes unlimited block Teach/Trace mode and DXF import Blocks with Plasma Intercon.

16.) added DXF colors to the color picker

VCP Background Color	:		# a6a5a5
DXF Unselected Color	:		# 7f7f7f
DXF Selected Color	:		# d00000
DXF Highlight Color	:		# ff0000
DXF Zero Reference Color	:		# 00ff00
Catch All Color	:		# fff700

17.) Added Wizard ATC menu tool change “Flyover” Z height position clearance position. This is the height that the Z axis goes to in between the tool put away and the new tool (flying over the tools). This is a machine coordinates value. ( Note: Previous version used hard coded (in the macro) machine coordinate Z0. Now user can specify tool clearance Z height from one tool position to the next.) This value is set in the Wizard ATC. The Wizard writes this value to the CNC12 G30 position and the Wizard generated ATC macros use G30 to command movement to the flyover position.

### ATC Setup

ATC Type \* Requires a Pro, Ultimate, or Ultimate Plus License

RackMount ▼

Custom Tool Change Macro (M6) in use No

Number of Pockets 0

**Machine Position Z Height Flyover** 0

Tool Rack Holding Configuration Hole

Fork Engage/Disengage Speed 50

Choose Rack Mount Tool Length Method

- Measure Tool Length after each Tool change at a [Fixed Tool Touch Off](#) position
- Measure Tool Length after each Tool change using Surface Plate (operator will be prompted)
- Maintain Tool Length Offset Library (requires accurate homing) and do not measure tool length with every tool change

	X Position	Y Position	Distance and Direction to Clear	Clearing Axis	Z Height
Pocket 1 (Bin 1)	0	0	0	1	0
Pocket 2 (Bin 2)	0	0	0	1	0

Note: the Acorn and AcornSix ATC Wizard setup page currently supports 16 pockets for Rack Mount setups, but the user can “manually” add as many additional tools to the Rack mount setup as they like. The future Wizard ATC menu will support more pockets so the user doesn’t have to copy/paste and edit files to add more than 16 pockets.

For example to add four more pockets for a total of 20, navigate to the C:/cncm/system/rackmountbins folder, ATC pocket files called: tool#position.cnc (Where # is tools 1-16). Copy anyone of these files and create a Tool 17 file from it: “tool17position.cnc”, then do the same for Tool 18 “tool18position.cnc”, etc..etc.. Ensure the naming is identical to the others so tool17position.cnc, tool18position.cnc and etc. Then edit the X, Y, Z positions and the other lines within these new tool position files for that tool. The macros are commented so it is simple to understand how they work.

(Download v5.02 here:

[https://www.centroidcnc.com/centroid\\_diy/centroid\\_cnc\\_software\\_downloads.html](https://www.centroidcnc.com/centroid_diy/centroid_cnc_software_downloads.html))

1.) Fixed Acorn/AcornSix Wizard ATC menu bug where it would not remember settings if it wasn't an integer. Also, added selection for fixed or not fixed TT for Rack Mount "Maintain Tool Offset Library" selection in the ATC Wizard setup menu to tell the CNC12 tool library auto measure F key to used fixed TT location or not.

2.) Improved Acorn/AcornSix Rack Mount ATC macros. Improved macros automatically check to see if any of these inputs are assigned and uses them if they are.

Inputs: DrawBarReleased or ToolisUnclamped, SpindlesOriented, VFDZeroSpeed,, PressureLowMessage or PressureLowStop or ATCAirPressureOk (recommend ATCAirPressureOK for ATC applications).

Outputs: Orient Spindle, UnclampTool and ATCAirBlowActivate

The Wizard generated v5.02 ATC macros work with any combination of these Input and outputs, and even no inputs or outputs at all!

3.) Added spindle cooling fan delta timer to the Wizard (P997). This delay timer works automatically in conjunction with the output "SpindleCoolingFan" and will keep the fan on for what ever amount of time is specified.

4.) Fixed an issue where laser ballscrew (position) compensation was only working for the first three axes.

5.) Added Plasma Cutter compatibility additions in plasma macros for support of Everlast and Primeweld cutters.

6.) Updated Plasma profiles to support Arc Ok for non-hypertherm cutters.

7.) Fixed a bug where Plasma Restart Mode would not use commanded feedrates when resuming a job.

8.) Options screen reinstated to Oak, Allin1DC and MPU11 installations which was accidentally omitted in v5.0

9.) Deprecated Skinning call Job.GetUserVolatileSystemVariable. Added Skinning calls Job.GetUserSystemVariable (#100-#159, #29000-#31999) and Job.GetUserStringSystemVariable (#300-#399) This is better because now this gives access to all user variables.

10.) Plasma Intercon graph will now zoom towards the center of the graph, rather than towards (0,0) and added option to 'flip' x y for viewing the way the user would like to see the display.

11.) Fixed Plasma screen flicker when using keyboard jogging.

12.) Improved the M44 Surface Plate macro to be more robust.

13.) Added support for WMPG-6+ in the stock Oak and Allin1DC standard PLC programs. Updating the stock ATC PLC programs is still in progress and will be committed in next release. (user can always edit their own as well)

14.) Reinstated "Trail On" in Plasma in Run time graphics

Release notes for previous version v5.0

[https://www.centroidcnc.com/centroid\\_diy/downloads/centroid\\_cnc12\\_download/centroid\\_cnc12\\_v5.0\\_release\\_notes.pdf](https://www.centroidcnc.com/centroid_diy/downloads/centroid_cnc12_download/centroid_cnc12_v5.0_release_notes.pdf)

## Unified Centroid CNC12 v5.0 for Acorn, AcornSix, Oak, Allin1DC, MPU11 and Hickory

This is a Free Centroid CNC12 Software for anyone using the Acorn, AcornSix, Oak, Allin1DC, and MPU11 and Hickory CNC controller platforms.

- All existing License files work with v5.0
- All CNC features from previous versions of CNC12 are included in v5.0

CNC12 v5.0 installer download link.

[https://www.centroidcnc.com/centroid\\_diy/centroid\\_cnc\\_software\\_downloads.html](https://www.centroidcnc.com/centroid_diy/centroid_cnc_software_downloads.html)

### **v5.0 release notes. Changes from v4.82 and v4.22 4-26-23**

- Improved the Installer Ethernet adapter auto configuration with more robust auto configuration and easier to understand UI
- Added Sub Net check to the installer when ensuring that network adapter is already set
- CNC12 checks if an IP address and subnet mask are set to 10.168.41.1 255.255.255.0 before trying to communicate with the board.
- Added Windows .NET 4.8 installer launch if Centroid installer detects it isn't installed. Microsoft .NET Framework v4.8 or greater is a requirement for the VCP to work so, now the CNC12 installer checks to see if it is installed on the CNC PC Windows installation and warns the user if Windows needs to be updated in this regard. If so, installer will ask you if you want to install the required .NET framework.
- Added Windows Region check and message to the installer.  
"Please set Windows Regional Format to: "English (United States)" before running the CNC12 Installer.  
See TB#309 for more information [https://www.centroidcnc.com/dealersupport/tech\\_bulletins/uploads/309.pdf](https://www.centroidcnc.com/dealersupport/tech_bulletins/uploads/309.pdf)
- Added skinning calls CSR.DisableCSR and CSR.ReenableCSR
- In general, features from the Oak/Allin1DC branch of CNC12 have been added to the Acorn Branch and features from the Acorn branch of CNC12 have been added to the Oak/Allin1DC/MPU11 Branch
- AcornSix: Six Axis Interpolated Simultaneous motion feature now included with the installation of a AcornSix Ultimate Plus License.
- AcornSix: New "Scales for Position Correction" setup menu added to the AcornSix Wizard.
- Added CNC12 Color Picker for use of custom colors sets with CNC12. Yes now you can change any and all colors of the CNC12 GUI.
- AcornSix: Support for the new WMPG-6 (the six axis version of the WMPG-4) has been added to the Wizard.
- Added AcornSix Wizard menu for second spindle setup. (Note: Parm 459 is Second Spindle Enable, Parm 460 is Second Spindle Max Speed, Parm 461 is Second Spindle Min Speed, Parm 462 is Second Spindle Encoder Count, Parm 814 is read for Second Spindle Analog Limit, Parm 78 bit 3 is Second Spindle Encoder Enabled)
- Plasma Intercon: Teach Mode menu improvements to the GUI. Teach Mode now supports Laser Cross Hair tracing/manual tracing/digitizing.
- Plasma Intercon: Added Presets for DXF/SVG imports
- Plasma Intercon: Added hover preview to graph

- Four more rows have been added to the VCP
- The VCP Reset, Feedrate, VCP options, and Push To Free buttons are no longer hard coded and can be edited or deleted by the user just like any other buttons.
- VCP Background color can now be changed via the Color Picker.
- Simple PLC Diagnostic has dynamic colors based off of the colors set for CNC12 using the Color Picker.
- Search function has been added in the optional DOS style file menu.
- Added missing MPG Macros for Acorn Six Router and Mill
- Fixed CNC12 issue when after a certain amount of time it would not be able to open more files.
- Up to 128 timers are now supported.
- Changed Rack Mount ATC page in the Wizard to ATC Setup for setting up more ATC types than just Rack Mount.
- Y axis is now available on the Lathe
- Added vertical and horizontal alignment, type and significant nodes to plc\_word node allowing for more customization of the plc\_word display
- Added the ability for users to display plc word values on the VCP (see below for more info)
- Added push button .001 +/- incrementing to WCS origins menu
- Added CNC12 Color Picker Icon.
- Updated the Lathe threads database with more threads.
- Fixed issue with the Wizard setting home limits for axes that have N labels
- Added Acorn Six Drive Types for Wizard.
- Added M18 and M6 to Mill and Router for Wizard Rack ATC Functionality.
- Added "Print Screen" to the Wizard. Press <CTRL and P> to create a PDF of each Wizard menu with the current settings.
- Accelerated graphics defaulted to be on for Oak, Alin1DC, MPU11
- Added skinning calls GetUserVolatileSystemVariable, GetJobRepeatState, SetJobRepeatState, GetPartCount, and GetPartNumber
- Implemented Volumetric Compensation feature as a beta feature. Requires Ultimate or Ultimate Plus license. More info on how to setup and use VC will be posted on the Centroid Tech support forum.
- Fixed Oak/Alin1DC innocuous "412 MPG\_ encoder error" that occurred with WMPG on power up.
- Fixed WMPG will now display during runtime graphics
- Improved Autosquaring macros to support wider variances in user setup configurations
- Plasma Restart Mode can now use G-code programs without spaces
- Reworked probe input (trigger and detection) firmware to unify logic across all hardware platforms. Needs

tested, Note: since this is 'low level' change be cautious on your testing, hand trigger probes before running a probing cycle to verify proper operation.

- Added user variables #27901-27908 for the axis home rate. Typically set by Wizard. But also can be used for custom home programs. Example M106/X P1 F#27901 ; seek home switch in X positive, look for input 1, move at feedrate specified by value in #27901

- Fixed issues importing licenses when they had lines terminated with non-Windows line endings. Reduces support issues related to users downloading license.dat file on non windows devices.

- Added F3 "Machine Notes" button in User Maintenance menu to open "machine\_notes.txt" from cncm or cncf folder in text editor. Integrators asked for this so they can save a .txt file with any notes about the machine and control customizations and obvious other uses.

- Added Clearpath Hard Stop homing option and supporting home routine in homing wizard see TB319 for more info. [https://www.centroidcnc.com/dealersupport/tech\\_bulletins/uploads/319.pdf](https://www.centroidcnc.com/dealersupport/tech_bulletins/uploads/319.pdf)

- Added one shot selections to the Wizard VCP aux key assignments page for mill/router and lathe

- Added "One Shot" common Lathe operations to the Lathe VCP (Virtual Control Panel)



- To avoid unexpected movement, Keyboard jogging will disable itself and re-enable when leaving and entering the main menu. KB jogging can still be enabled in any menu by alt+j after being disabled by cnc12. For instance if keyboard jogging is active and user navigates to the CNC12 parameters menu, cnc12 will suppress keyboard jogging while in that menu and reactivate it when navigating back to the main menu of CNC12.
- Plasma Intercon: Added support for the DXF entity LWPOLYLINE
- Wizard ATC menu added a : "Fixed or Slider" Carousel ATC type selection.
- Added system variable SV\_PLC\_DISABLE\_TRAVEL\_LIMITS that can be set by a PLC program to disable travel limits when jogging or using the MPG. Example: IF INPUT THEN ( SV\_PLC\_DISABLE\_TRAVEL\_LIMITS)
- VCP plc words now scales better in other 16:9 aspect ratio monitor resolutions other than the recommended 1920x1080.
- Fixed some cases of parsing errors with M120, M121, M223, M225, G65, and string user variable assignments when a semicolon appeared in a quoted string.
- Standardized and consolidated Allin1dc Mill PLC programs included with the CNC12 installer. This is the beginning of an overhaul of the "Stock" PLC programs included with the CNC12 installer with the goal to make PLC program selection for Oak and Allin1dc less confusing by improving standardization and eliminating old outdated files.
- renamed ncfles\stressTest.cnc to "com\_stress\_test.cnc", left a copy of old stress test for now. No difference in the files, just a renaming.
- report.zip report now names the hardware AcornSix, Hickory, Oak, Allin1dc etc instead of generic "servo"
- Reverted g code file lock by cnc12 with G code preview feature to eliminate high cpu usage with large g code files. We will revisit this in the nex rev.
- Added "Cycle Start from Graph Menu" functionality. Acorn and AcornSix Wizard selectable ON/OFF and/or CNC12 parameter 400 is set to 1.
- Added WMPG Z axis x100 fast movement inhibitor., Acorn and AcornSix Wizard selectable and/or CNC12 Parameter 450 = 1 x100=x10 for Z axis when P450=1
- Added a "show 'hidden' parameter numbers" indicator in the Wizard. See which CNC12 parameters the Wizard is setting via alt+p.
- CNC12 Main menu now shows software/hardware version info on the Home not set screen as well as util and setup menus
- Added features in WCS Origin menu: Copy/Paste for cell/column, clear cell/column, and increment mode for adding entry to existing cell value.
- Added "Teach" button in WCS Return menu to copy axis machine coordinate value to the table
- Added support for WMPG-6 Six axis wireless MPG
- Wizard now will not let user pair an axis unless License file is installed to avoid confusion on why software pairing doesn't work (without a license installed)
- Ported Acorn user friendly Probe state graphics from Acorn Branch to Merge branch.
- Improved Wizard UI by adding AcornSix boot up LED1 animation to Wizard
- Set WCS menu plus and minus F keys to .01 mm for metric installations.

- misc. C axis setup improvements
- Eliminated a key stroke to install Acorn/AcornSix license file. Now "Import License" is direct with F8 key in utility menu.
- Added progress bar to Wizard while writing settings to CNC control
- Eliminated unwanted click and hold drag and drop feature from wizard tables.
- Fixed syntax error in Acorn resulting from semi colon use with certain variables
- Added ctrl+f to search in the PLC detective
- Updated main control board detection code so, when using with Acorn, you may get a (one time) error message that looks like this. Press F1 continue and you will never get this message again.

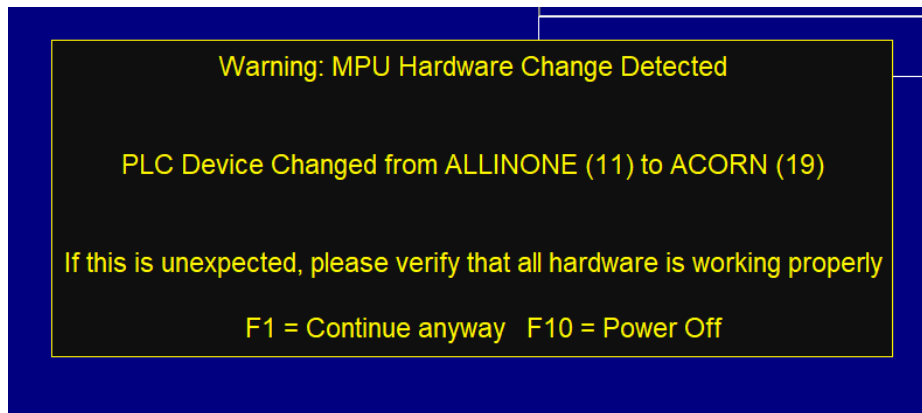

- Updated the license/version mismatch message to provide more guidance to the user.

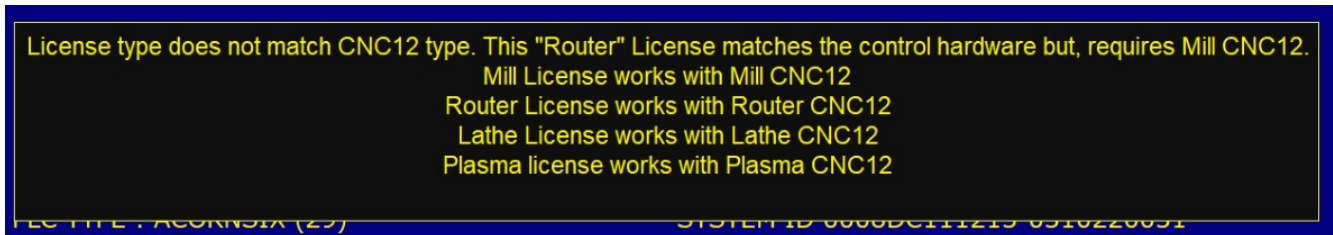

- Added Fast Plus, Fast Minus jogging speeds to the Acorn/AcornSix Wizard and the updated jog speed CNC12 config menu.

Lead Comp. inches	0	0	0	0
Max Rate in./min or deg/min	50	50	50	360
Fast Jog Plus Direction in./min or deg/min	50	50	50	360
Fast Jog Minus Direction in./min or deg/min	50	50	50	360
Slow Jog in./min or deg/min	10	10	10	36
Accel / Decel seconds	0.5	0.5	0.5	0.5

Jog Parameters					
Machine	Machine	Machine			
Axis	Slow Jog (mm/min)	Fast Jog (-) (mm/min)	Fast Jog (+) (mm/min)	Max Rate (mm/min)	Deadstart (mm/min)
1	254	1270	1270	1270	127.00
2	254	1270	1270	1270	127.00
3	254	1270	1270	1270	127.00
4	36	360	360	360	5.00
5	1270	5080	5080	5080	127.00
6	1270	5080	5080	5080	127.00
7	635	5080	5080	5080	127.00
8	635	5080	5080	5080	127.00

- Added Probe Fast Minus, Probe Slow rates to Acorn/AcornSix Wizard and to the CNC12 config menu

### Probe Configuration

Probe PLC input

Probe type Mechanical

Input state when tripped Closed\*   
[\\*Probe Setup Documentation \(PDF\)](#)

Probe tool number

Fast probe rate

Slow probe rate

Recovery distance

Maximum probing distance

Probe Protection Enabled Yes

Inhibit Spindle when Detect is on (Green) Yes

Display Warning to Verify that Probe or TT is functioning properly Yes

  

	Axis 1	Axis 2	Axis 3	Axis 4
Probe Slow Jog <small>(in/min)</small>	10	10	10	10
Probe Fast Jog (-) <small>(in/min)</small>	50	50	50	50
Probe Fast Jog (+) <small>(in/min)</small>	50	50	50	50

### Jog Parameters

Axis	Probe Slow Jog (mm/min)	Probe Fast Jog (-) (mm/min)	Probe Fast Jog (+) (mm/min)
1	500	1270	1270
2	254	1270	1270
3	254	1270	1270
4	10	50	50
5	254	1270	1270
6	254	1270	1270
7	254	1270	1270
8	254	1270	1270

- Added Homing Feed rates for each axis to the Acorn/AcornSix Wizard and new Machine home speed CNC12 config menu The Automatic Wizard generated home program will use these values.

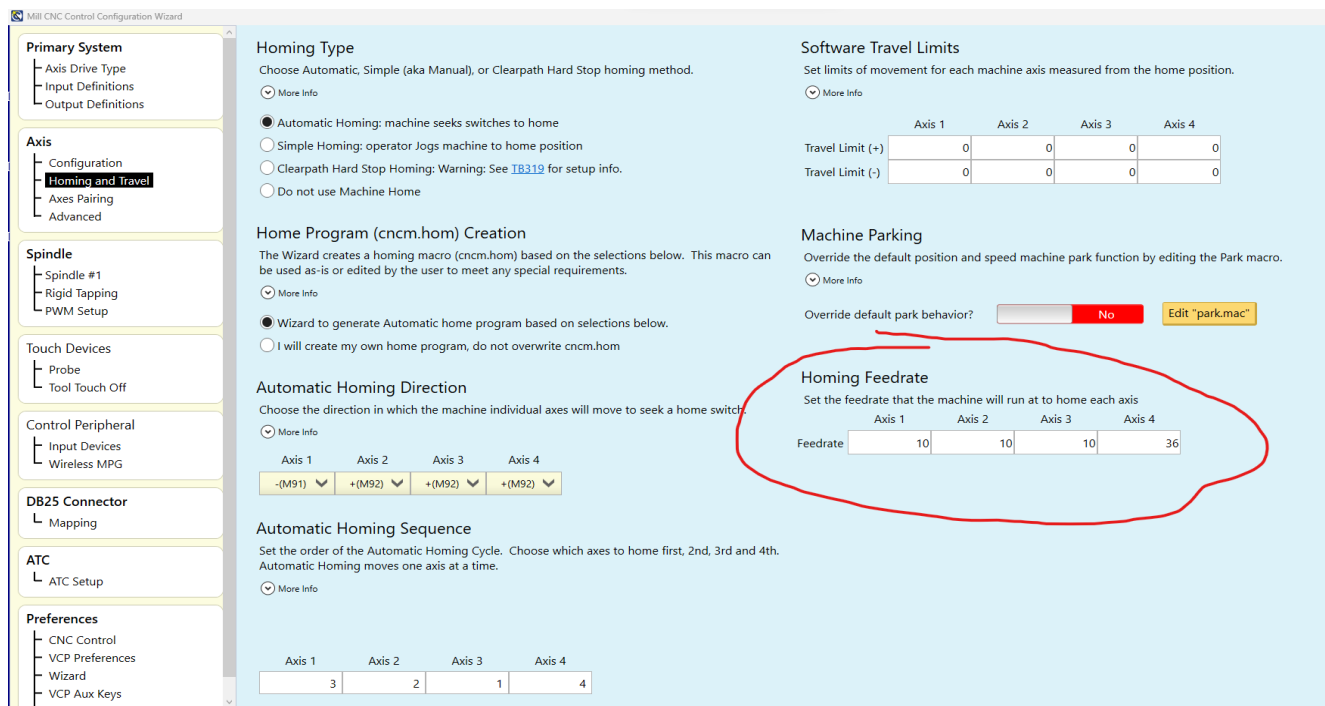

- Added Plasma Router Swap Automatic setup in the installer. This allows user to easily switch from Router CNC12 to Plasma CNC12 on the same machine.

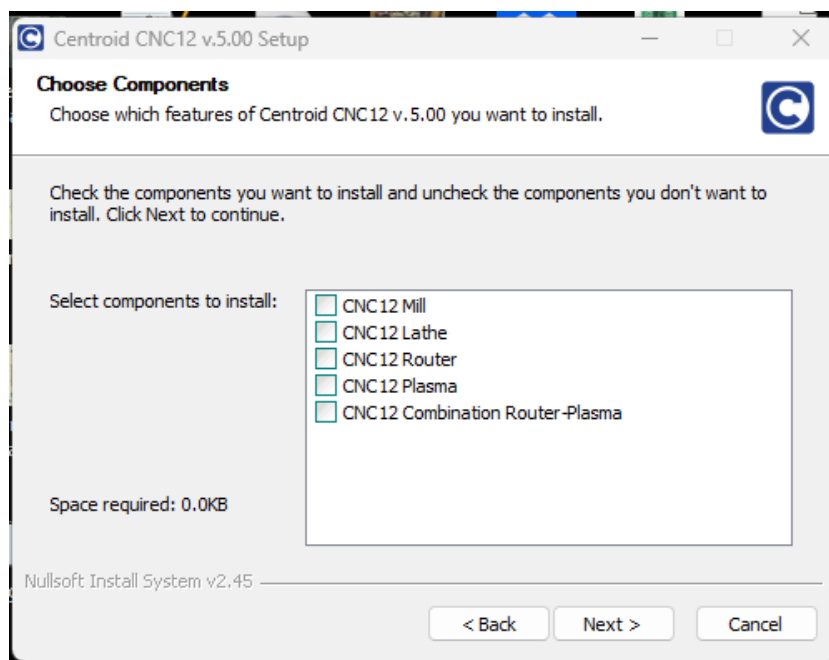

- Added error checking and better detection for available network adapters by the CNC12 installer

Now the installer will notice if there is already an Ethernet port setup for CNC use and ask if you want to use it.

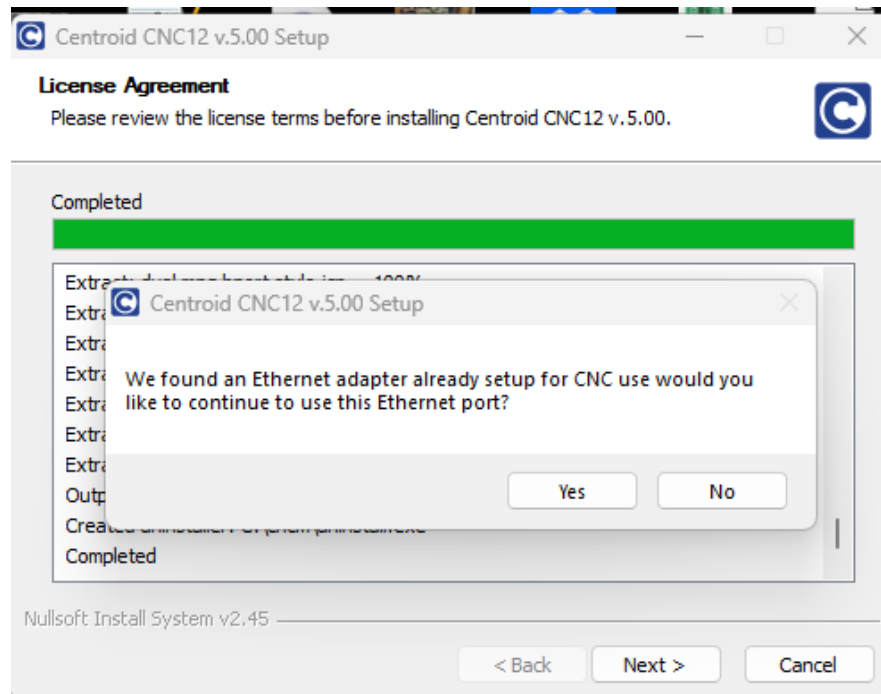

- Hickory CNC control board option added to the CNC12 installer selection of CNC control board models.

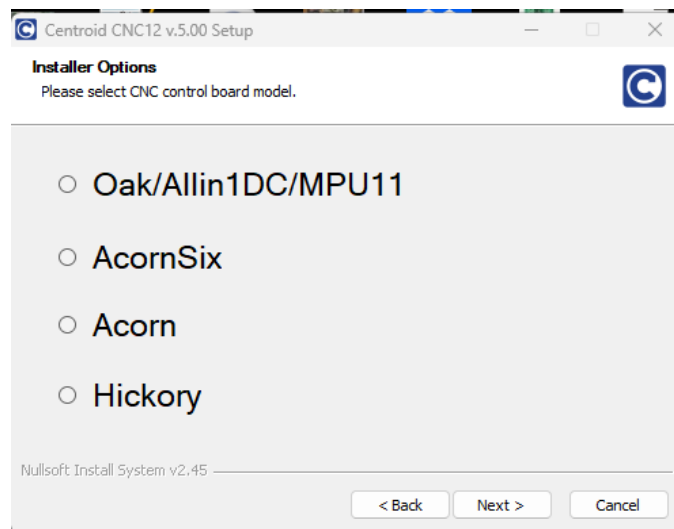

- Improved system identification now displayed on the start up screen (as well as the setup screen and the options menu)



- We eliminated File Backup and Restore F keys in the Utility menu. These two F keys are throw backs to the DOS and Linux days when average users found it difficult to copy G code programs to another folder for backups. Use Windows file explorer to copy/move/delete files.

- Fixed M58 VCP button in Acorn / AcornSix ROUTER VCP that was broken in v4.82 in regards to installing swissi's excellent ProbeApp software for CNC12. More info on probe app here. <https://centroidcncforum.com/viewtopic.php?f=60&t=6149>

- When working with an AcornSix always power cycle the AcornSix board after a configuration, parameter or PLC change.

- One CNC12 installer for all current Centroid CNC control platforms. Acorn, AcornSix, Oak, Allin1DC, and MPU11

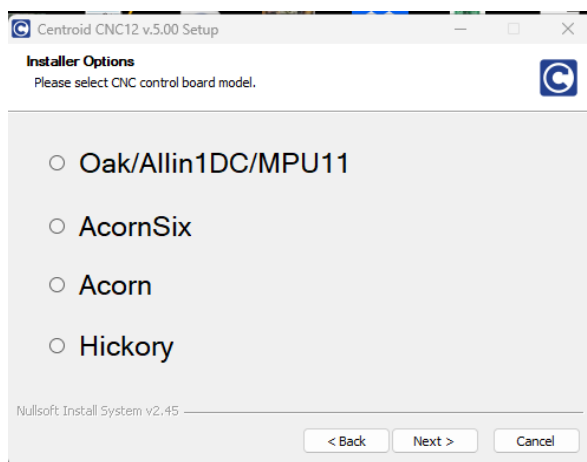

- Added "remember last directory visited" feature for Windows F2 Load to parameter 4. Add 16 to the default value of 9 to enable this feature. (P4 = 25)

# Acorn ATC Wizard menus: Mill and Router, Rack Mount and Carousel.

Mill CNC Control Configuration Wizard

**Primary System**

- Axis Drive Type
- Input Definitions
- Output Definitions

**Axis**

- Configuration
- Homing and Travel
- Axes Pairing
- Advanced

**Spindle**

- Spindle #1
- Rigid Tapping
- PWM Setup

**Touch Devices**

- Probe
- Tool Touch Off

**Control Peripheral**

- Input Devices
- Wireless MPG

**DB25 Connector**

- Mapping

**ATC**

- ATC Setup**

**Preferences**

- CNC Control

### ATC Setup

ATC Type: RackMount \* Requires a Pro, Ultimate, or Ultimate Plus License

Custom Tool Change Macro (M6) in use: No

Number of Pockets:

Tool Rack Holding Configuration: Fork

Choose Rack Mount Tool Length Method

- Measure Tool Length after each Tool change at a Fixed Tool Touch Off position
- Measure Tool Length after each Tool change using Surface Plate (operator will be prompted)
- Maintain Tool Length Offset Library (requires accurate homing) and do not measure tool length with every tool change

Fixed Tool Touch Off X Y Z Position (machine coordinates):

Fixed TT for Tool Offsets used with movable Surface Plate WCS part Zero: No

	X Position	Y Position	Distance to Clear	Clearing Axis	Z Height
Pocket 1 (Bin 1)	0	0	0	1	0
Pocket 2 (Bin 2)	0	0	0	1	0
Pocket 3 (Bin 3)	0	0	0	1	0
Pocket 4 (Bin 4)	0	0	0	1	0
Pocket 5 (Bin 5)	0	0	0	1	0
Pocket 6 (Bin 6)	0	0	0	1	0
Pocket 7 (Bin 7)	0	0	0	1	0
Pocket 8 (Bin 8)	0	0	0	1	0

Mill CNC Control Configuration Wizard

**Primary System**

- Axis Drive Type
- Input Definitions
- Output Definitions

**Axis**

- Configuration
- Homing and Travel
- Axes Pairing
- Advanced

**Spindle**

- Spindle #1
- Rigid Tapping
- PWM Setup

**Touch Devices**

- Probe
- Tool Touch Off

**Control Peripheral**

- Input Devices
- Wireless MPG

**DB25 Connector**

- Mapping

**ATC**

- ATC Setup**

**Preferences**

- CNC Control

### ATC Setup

ATC Type: Carousel \* Requires a Pro, Ultimate, or Ultimate Plus License

Carousel Type: Fixed

Custom Tool Change Macro (M6) in use: No

Number of Pockets:

Skip First Count on Carousel Reversal: No

Tool Change X Value:

Tool Change Y Value:

Tool Change Z Value:

Distance to Clear:

Clearing Axis:

After configuration, the ATC must be initialized in CNC12  
 F1(Setup) → F3(Config) → F6(ATC Init.) This will ask you to put Tool 1 into the spindle. Ensure the carousel is also at position for Tool 1 when performing ATC Init.  
 Note: This process is required to be repeated if the carousel loses position  
 \* Link to Acorn Wizard ATC setup guide  
[www.centroidcnc.com/centroid\\_diy/downloads/acorn\\_documentation/centroid\\_acorn\\_wizard\\_atc\\_setup\\_guide.pdf](http://www.centroidcnc.com/centroid_diy/downloads/acorn_documentation/centroid_acorn_wizard_atc_setup_guide.pdf)

And many Lathe Turret types are supported.  
Counter based Turret, Time based Turret, Axis motor driven turret, Grey code type 1, Grey code type 2!

The screenshot shows the 'Lathe CNC Control Configuration Wizard' interface. On the left is a navigation pane with the following sections: Primary System (Axis Drive Type, Input Definitions, Output Definitions), Axis (Configuration, Homing and Travel, Axes Pairing, Advanced), Spindle (Spindle #1, Rigid Tapping, PWM Setup), Touch Devices (Probe, Tool Touch Off), Control Peripheral (Input Devices, Wireless MPG), DB25 Connector (Mapping), ATC (ATC Setup), and Preferences. The 'ATC Setup' section is active, showing a dropdown menu for 'ATC Type' with options: None, Counter Turret, Time Turret, Axis Driven Turret, Grey Code 1, and Grey Code 2. A note states: '\* Requires a Pro, Ultimate, or Ultimate Plus License'. Below the dropdown, it says 'After configuration, the ATC must be initialized in CNC12'. Further instructions include: 'F1(Setup) → F3(Config) → F6(ATC Init.) This will ask you to put Tool 1 into the spindle. Ensure the carousel is also at position for Tool 1 when performing ATC Init.' A note follows: 'Note: This process is required to be repeated if the carousel loses position'. A link is provided: '\* Link to Acorn Wizard ATC setup guide' with the URL [www.centroidcnc.com/centroid\\_diy/downloads/acorn\\_documentation/centroid\\_acorn\\_wizard\\_atc\\_setup\\_guide.pdf](http://www.centroidcnc.com/centroid_diy/downloads/acorn_documentation/centroid_acorn_wizard_atc_setup_guide.pdf).

## Virtual Control Panel additions for v5.0

The VCP now supports a new feature called "PLC Words". PLC Words allows you to display CNC data on the VCP in real time gathered from the PLC program. Analog input as a word value (number).

Below is a sample VCP XML file using PLC words to display in real time on the VCP the current Feedrate Override Percentage value.

```
<image>
  <column_span>3</column_span>
  <column_start>4</column_start>
  <row_span>1</row_span>
  <row_start>11</row_start>
  <path>C:\cncm(t)\resources\vcplimages\feedrate_override.svg</path>
</image>
<border>
  <column_span>3</column_span>
  <column_start>4</column_start>
  <fill>Transparent</fill>
  <row_span>2</row_span>
  <row_start>11</row_start>
  <outline_color>#000000</outline_color>
  <outline_thickness>1</outline_thickness>
  <plc_word>
    <number>31</number>
    <color>#000000</color>
    <fontsize>20</fontsize>
    <font>Arial</font>
    <fontstyle>bold</fontstyle>
    <verticalalignment>center</verticalalignment>
    <horizontalalignment>center</horizontalalignment>
    <marginbottom>30</marginbottom>
    <marginright>10</marginright>
  </plc_word>
</border>
<button row="11" column="1" column_span="3" row_span="3">reset</button>
<button row="12" column="4">feedrate_negative</button>
<button row="12" column="5">feedrate_100</button>
<button row="12" column="6">feedrate_positive</button>
<button row="14" column="4">vcp_options</button>
<button row="14" column="5">push_free</button>
```

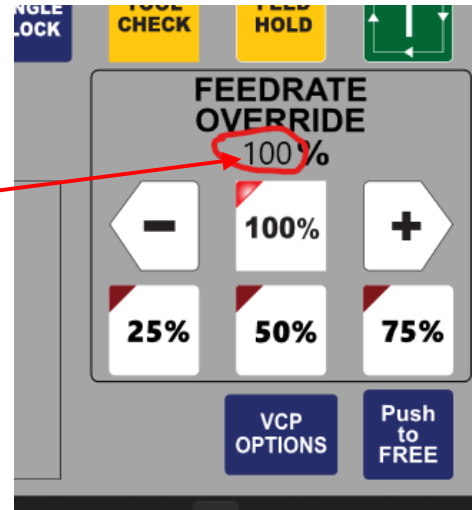

This new feature allows users to display PLC Words directly on top of the VCP. The user can display the PLC Words on any VCP button or on the VCP borders. To display a PLC word simply add the plc\_word node within a border node or a vcp\_button node. An example of a plc\_word node is below.

```
<plc_word>
  <number>31</number>
  <type>float</type>
  <significant></significant>
  <color>#000000</color>
  <fontsize>20</fontsize>
  <font>Comic Sans MS</font>
  <fontstyle>bold</fontstyle>
  <verticalalignment>center</verticalalignment>
  <horizontalalignment>center</horizontalalignment>
  <marginbottom>30</marginbottom>
  <marginright>10</marginright>
  <marginleft>5</marginleft>
  <margintop>5</margintop>
</plc_word>
```

The plc\_word has several control settings that the user can use to style and place the PLC word.

In order to use the plc\_word node, the user must set the number node which is the number that the plc word is in the PLC. See the feedrate override % value as an example.

The type node sets what type of plc word the user wants displayed. This is defaulted to Int type if no other types are set. Types Are: Int (Int = Interger such as 10), Float (Float – Floating Point vaule such as 10.1234). valid values are in the range of -2147483648 to 2147483647 (Typically not used but are available Double (64 bit), DoubleFloat (64 bit) which doubles the range values -9223372036854775808 to 9223372036854775807)

The significant node is for all plc word types except Int. This tells the VCP how many digits after the decimal point a user wants displayed. This is defaulted to 2.

The color node sets the color of the text displayed. This must be in hex code like example. This is defaulted to #000000.

The font size node sets the font size for the text. This must be an integer value. It is defaulted to 16.

The font node allows the user to set the font of the text. This is defaulted to Segoe UI. The list of fonts allowed are here, <https://learn.microsoft.com/en-us/typography/font-list/>. Users must put the font name in exactly as it is displayed in the list, spaces and all.

The font style node sets the style that the text is displayed in. This is defaulted to normal. The user can also set it to be bold, italics, normal or oblique.

The vertical alignment node sets the vertical alignment of the text displayed. The default is bottom. The user can set it to be top, center, or bottom.

The horizontal alignment node sets the horizontal alignment of the text. This is defaulted to left. The user can set it to be left, right, center.

The lastly the margin bottom, top, left, and right nodes sets the margins on the text. This allows users to fine tune where the text is displayed. This must be an integer and it is defaulted to 0.

Many PLC words are predefined in the Centroid provided and Wizard Generated PLC programs. They can be found under the Word Definitions section of the PLC program.

A number assigned to each of the PLC values.

For example "W31" is Word #31 which equals the current Feedrate Override Percentage value.

Commonly used stock PLC Word values are:

Spindle Speed Override %(SpinOverride\_W is W19)  
Feedrate Override % (FinalFeedOverride\_W is W31)  
Target Voltage Override %(TargetVoltage\_W is W7)  
Current Carousel Position (CurrentCarouselPosition\_W is W54)  
Current Turret Position (CurrentTurretPosition\_W is W52)

Below is an excerpt from the Acorn Mill PLC program showing the stock PLC Word Definitions.

```
-----  
;  
; Word Definitions  
-----  
  
SkinFeedOverride_W1      IS W1  
TotalOffsetAppliedFW     IS W2  
JogIncMultiplier        IS W3  
ZJogOffset              IS W4  
ZAxisEncoder            IS W5  
TorchVoltage_W          IS W6  
TargetVoltage_W         IS W7  
Last_TorchKnob_W       IS W8  
  
ShuttleAxisSelect_W     IS W10  
ShuttleResumeFeedOver_W IS W11  
SkinningInt12_W        IS W12  
TwelveBitSpeed_W       IS W13  
FaultMsg_W             IS W14  
ErrorMsg_W             IS W15  
InfoMsg_W              IS W16  
  
SpinOverride_W          IS W19  
Mem_W                  IS W20  
Out_W                  IS W21  
MpgOffsetWord          IS W23  
  
SpindleRange_W         IS W24 ; 1 = low ... 4 = high  
PrevFeedOverride_W    IS W25  
  
UsbAxisMonitor_W       IS W26  
UsbScaleMonitor_W     IS W27  
  
AtcType_W              IS W28  
KbOverride_W           IS W29  
FeedrateKnob_W        IS W30  
FinalFeedOverride_W   IS W31  
Last_FeedrateKnob_W   IS W32  
LastKbOverride_W      IS W33  
LastSkinFeedOverride_W IS W34  
UsbJog_W              IS W35  
  
MiniPLCStatus_W       IS W36
```

JogKeyCfg_W	IS W37
UsbButtonMonitor	IS W38
UsbWheelCurrent	IS W39
UsbWheelLast	IS W40
UsbWheelDelta	IS W41
UsbMpgActiveAxes_W	IS W42
DefaultJogging_W	IS W43
LastCarouselDir_W	IS W49
PutBackPosition_W	IS W50
CurrentTurretPosition_W	IS W52
RequestedTurretPosition_W	IS W53
CurrentCarouselPosition_W	IS W54
RequestedCarouselPosition_W	IS W55
CycloneStatus_W	IS W56
THCEncoderStatus_W	IS W9;57
PLC_Fault_W	IS W61
PLCFaultAddr_W	IS W62

Users can create their own Word Values here is an example of How to Display a Lathe Turret Position on the VCP.

How to create a word value that will “track” a 4 Tool Turret Location and then display Turret Position word value on the VCP to track turret location. This example will use a Typical Lathe Turret that has 4 separate inputs for each position. First we must define our word value in the PLC program and add the logic for that word value.

```

;-----
;                               Word Definitions
;-----
CurrentTurretPosition_W      IS W52

```

Next we will setup the logic that will assign values to our word value. The following code will set the Word value from 1 to 4 based on the Input.

```

IF TurretInput1 THEN CurrentTurretPosition_W = 1
IF TurretInput2 THEN CurrentTurretPosition_W = 2
IF TurretInput3 THEN CurrentTurretPosition_W = 3
IF TurretInput4 THEN CurrentTurretPosition_W = 4

```

Now when Input 2 is ON, the word value will be set to 2 for example. Now we want to see our current tool on our VCP button. We will add the word value 52, as we have defined in the PLC to the Button.xml file that we would like this value to be displayed on top of like so,

```

<plc_word>
  <number> 52</number>

```

Now when the tool turret changes tools, the current turret position will be displayed on that VCP button.

This is a simple example, however any value in the PLC when assigned a Word value can be displayed on the VCP. More complicated applications can be for example, displaying an analog Input from a pressure gauge, displaying calculated math done by the PLC, or even system variables (If its a 32 bit word variable).

## **Acorn Features added to Oak/Allin1DC/MPU11/Hickory that are controlled by parameter values.**

Note: For Acorn and AcornSix these features are set/adjusted using the Acorn and AcornSix Wizard, If you have an Acorn or AcornSix use the Wizard to control how you would like these features to work, no need to adjust a the parameter level. Press <Alt P> in the Acorn/AcornSix wizard to see the parameters being set by the Wizard.

If you have and Oak, or Allin1dc, or MPU11 or Hickory these features are controlled by parameter values (like all other adjustable CNC12 features for Oak, or Allin1dc, or MPU11).

- Preview gcode before running file (parm 417)
- Mini machine coordinates display (parm 143 add 64)
- Change dro display precision (parm 263)
- Active Gcode display changes
- Right Click and Close Application on CNC12 in the taskbar
- Beta expiration timer
- Run menu display changes
- Real time graph color changed form white to yellow
- Real time graphing screen has the drill removed from Acorn and distance to go, spindle speed and feedrate displayed
- Turn off Clean filter Message with Clean filter message parameter (parm 421)
- Using plc variables by their name in gcode files
- Open Keyboard jogging menu at startup (parm 148 add 4)
- Smart searching job by mcode
- G37 and Mcodes for laser
- Probe menu changes
- Simplified PLC Diagnostics (parm 422)
- Normally open probes detected like Acorn (parms 18 and 406)
- Display scale position on DRO (parm 423)
- CNC12 Color Picker (parm 7)
- Skinning check if CNC12 shutting down computer in sub applications
- Laser X and Y offsets (parm 560 and 561)
- 5th axis pairing (parms 64, 507, and 508)
- 2nd spindle (parms 78, 459, 460, 461, 462)

- 1.) Mill, Lathe, Router, Plasma: Fixed a rare intermittent file management bug that appears in some systems but not others. This solves the "(OPEN) Error saving offset library" and "(OPEN) Error saving tool library" error message issue.
- 2.) Plasma: Added Plasma oscilloscope plot button in Utility menu in CNC12 for opening the plot app inside of CNC12. Note the Centroid "Plot" program captures Actual Voltage, Position, Velocity for plasma machine performance analysis.
- 3.) Plasma: Restart mode improvements. Restart now supports M102 (Repeat) and Modified Feedrate by %
- 4.) Plasma: Plasma Intercon additions and improvements
  - Profile Feedrate Override Percentage added to events
  - DXF and SVG events now have cut direction
  - Canned cycles and kerf offset values are now modal
  - Clicking/Double clicking event will save currently edited event
  - Improved dxf/svg import
  - Color Picker dialog loads with hex code and color selected
  - Error catching for circular and rectangle frames
  - Subprograms update more consistently
  - F8 – Graph added to main screen
  - F8 – Graph reworked
  - Graph Preview works with collapsed groups
  - Fixed an issue with 3-point arcs
  - Fixed a graphical issue with rapids
  - Improved the Teach mode (tracing) window
  - Teach Mode (Tracing) now supports use of cross hair Laser to teach in endpoints for lines and arcs
  - Connecting radius to any event
- 5.) Plasma: Hypertherm Sync Plasma Material Profiles added to plasma resources folder.
- 6.) Fixed instance when Auto squaring fields are greyed out on load (bug fix)
- 7.) Skinning applications close before cnc12 turns off pc avoids windows error message about memory.
- 8.) Fixed the wizard not creating a correct homing file when the user is using limit switches
- 9.) Router/Mill: Added new Wizard menu/macros for writing laser offset data to parameters using parameters 560 and 561
- 10.) Router: Added Laser on/off and LASER Zero Check VCP buttons on stock Router VCP layout
- 11.) Plasma: Profile manager and Plasma Intercon Color Picker hex values can now be entered directly in the color picker dialog
- 12.) Plasma: Added capture on/off button in Utility menu in Plasma CNC12 for turning off or on capturing a plot for debugging as a convenience.

## Acorn CNC12 v4.80 Mill, Lathe, Router, Plasma Release Notes

1. Added support for XY Jogging in the VCP and Wizard for Mill, Router, Plasma. (Note: this feature works with Lathe as XZ jogging but is not implemented in the Wizard, simple hand edit VCP to enable for Lathe).



2. Improved G code backplot graphics speed, now much faster G code job display graphics.
3. Added support for WMPG-4 Plasma specific overlay skin in Plasma Wizard.

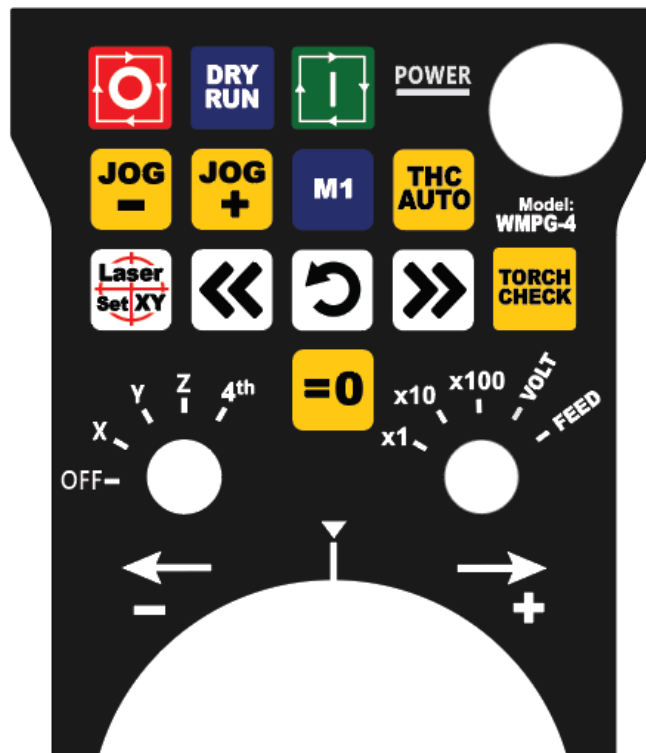

4. Fixed Lathe Offset Tool Measurement bug.
5. Fixed Keyboard Jogging bug when "PC Keyboard" was selected and Z axis would not jog with Keyboard arrow keys
6. Added Smart Sense functionality user choice in THC config menu. 1.) Sense voltage only at beginning of job. Or 2.) Sense voltage at beginning of every cut.

7. Added support for time based “marking” in Acorn Plasma. (M64)  
Added SpindleOK delay timer in Wizard for inverters that are not quick to send a Spindle Ok signal.
8. Added choice of spindle speed display type, Actual = Actual Encoder reporting speed, Programmed Spindle Speed = G code S function command value, or Display Both.
9. Added Communications Stress test file “stressTest.cnc” in \NCFILES. Run the G code file to stress test the Acorn to CNCPC communications link. This helps debug communications issues above and beyond a simple ping test.
10. Added Live Torch Voltage Oscilloscope feature to Plasma. A handy debug tool for the commissioning of Plasma systems.
11. Added a dedicated Virtual Control Panel Preferences menu to the Wizard.
12. Fixed issue with Windows Global font size messing up text in the Wizard.
13. Added ability to export tool height offset and diameter to both txt and csv for the mill tool library
14. Added GetFullPathJobNameCurrent, and GetCurrentLineInfo functions to the skinning api
15. Added Gecko Drive Type in Wizard for Gecko G203V
16. Lowered the cpu usage of the PLC Diagnostics app, and VCP for better system performance.
17. Added to Wizard Homing menu option to not use homing at all upon start up.
18. Added automatic current CNC12 installation directory backup to the CNC12 installer
19. Added a parameter to set the precision of DRO, now user can set how many decimal points are displayed in the DRO
20. The vcp will now not crash if the options.xml file is corrupt. It will create a new file with default values.
21. Added axes labels U and V to the Wizard and added vcp U V buttons for axes labels
22. Added GetJogState function to the skinning api
23. Added new system variables for the “get amount” of communication errors
24. Added message to status menu if there is more than 5 communication error messages within an hour
25. Defaulted RTG all machine types to to have no trail when real time graphing a job
26. Increased the responsiveness of the WMPG-4 for improved performance.
27. Added KL5056E Drive Preset for Acorn Wizard
28. Improved Lathe Homing images

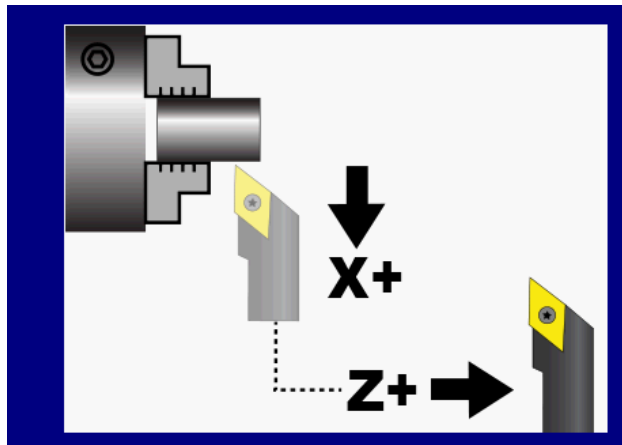

29. Added new functions to skinning api. The functions are for getting all the tools in tool library, getting tool description, and setting tool tool description
30. Added skinning function to get if the software has a pro, ultimate or free license
31. Added machine parameter 440 (Stop For Jogging Continue Bit) for which values 1-255 indicate the SV\_SKIN\_EVENT\_x to check for continuation during execution of an M0/M200/M201 command, along with CYCLE\_START and TOOL\_CHECK. A value of 256 will wait for the Skinning API call Job.ContinueExecution.

32. Added machine parameter 180 (Clear Limit Switch Distance). This parameter specifies the distance to move before generating an error when looking for the limit switch to be cleared during a homing (M91/M92) command. A value of zero will result in a default setting of using a distance of 0.5 inches or one motor revolution, whichever is greater. This distance only applies to a linear axis. If the axis is rotary, a distance of 45 degrees is used regardless of the parameter value.
33. Corrected Plasma issue causing SV\_STOP to be reset even when there was an active THCErrror
34. Fixed minimum S text box being multiplied by 10 when returning to the PWM setup menu.
35. Fixed issue with spindle benchtest job freezing cnc12 when graphed with rtg
36. Fixed simple plc cnc12 diagnostics showing INP number for outputs when there is no outputs

Free CNC support.

<https://centroidcncforum.com/viewforum.php?f=60&sid=16a1a2ff05cc2cdf3073d120d4ba0078>

Download and Unzip then click on .exe to run the installer.

Update Instructions.

Installation instructions for updating an existing installation of Acorn CNC12 to this version.

1.) Make screen shots of each Wizard menu of the existing installation so you have a visual record of the current Wizard settings. (Store copies of the report and screen shots in a safe place (even on another computer as an extra precaution would be a good idea as well)). Windows "Snipping Tool" is very handy for this. To find this program type in "snip" in the Windows search bar.

2.) Download and unzip the .zip" file

EXTRACT the zip file, open extracted folder and with the Acorn up and running with a heartbeat, Double click on the .exe and follow the instructions to install CNC12. You may run into a Windows warning notification: Click "More Info" then click "Run Anyway" to continue.

3.) With the Acorn up and running with a heartbeat double click on the CNC12 Icon to start CNC12. CNC12 will update the firmware on the Acorn BBG. Follow the instructions on the screen.

4.) Install the Acorn License file from the Acorn Utility menu, "Options" , then "Import License". Note: Mill, Lathe, Router License files used with older software will work with this version of Mill, Lathe and Router CNC12. If installing the new Acorn CNC12 Plasma a new Plasma Pro license file is required.

5.) Open the Wizard and re-enter the information and settings from the screen shots made in step 1 and press "Write settings to CNC control" and follow the instructions on the screen.

6.) For Plasma, continue the setup process in the Plasma installation manual. Start with Step 4

[https://www.centroidcnc.com/centroid\\_di...manual.pdf](https://www.centroidcnc.com/centroid_di...manual.pdf)

New CNC12 installation instructions.

[https://www.centroidcnc.com/centroid\\_di...manual.pdf](https://www.centroidcnc.com/centroid_di...manual.pdf)

If you have any custom macros or VCP buttons copy them over from the old install to the new install. same with tool libraries, custom home programs and wcs positions.

Alternatively the “restore report” feature can be used to copy files from the old install to the new install automatically.

- 1.) Run the Acorn CNC12 v4.80 installer.exe with Acorn powered up with heartbeat and connected to the CNCPC.
- 2.) Start CNC12 navigate to the Utility menu.
- 3.) Open the Acorn Wizard. Click on “Update Wizard”

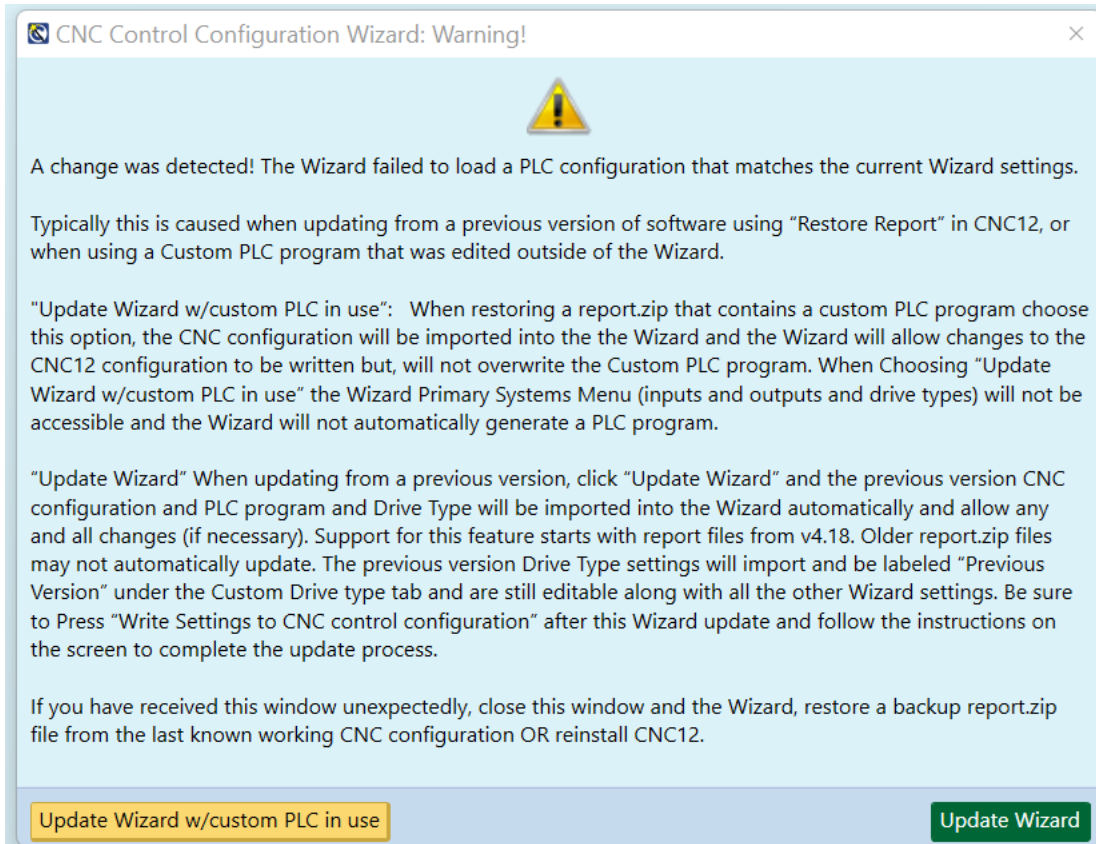

4.) Click on "Write Settings to CNC Control" and follow the instructions on the screen.



This is a critical step as the Wizard will create a new PLC program that works with v4.80 based on the previous Wizard settings avoiding the having to hand adjust all the settings in the Wizard and enabling new features not available in the previous version.

Pitfalls of this method:

- Using "restore report" in CNC12 without opening the Acorn Wizard and pressing "Write settings to CNC control configuration" will result in a mix mash of files that will not function properly.

- If a custom PLC program is in use in the previous version the recommended update method is to let the Wizard create a new v4.80 PLC program and then hand edit/insert the old PLC program customizations into the NEW v4.80 plc program. The reason for this is that the v4.80 has new features that the old PLC program does not have and by editing the new v4.80 Wizard generated PLC program you will get both customizations and the new features of v4.80.

1.) CNC12 "Router" now is a selection in the installer.

The Router version of Acorn CNC12 is as the name implies geared towards CNC router applications with a preconfigured Virtual Control Panel (VCP) with common Router functions and features. The Router VCP and its related router macros are fully edited and customize-able. So user can use as is or further customize the function/feature to their liking.

CNC12 Router and CNC12 Mill CAN NOT be installed on the same CNCPC at the same time.

CNC12 Router CAN be installed on the same CNCPC at the same time as CNC12 Lathe

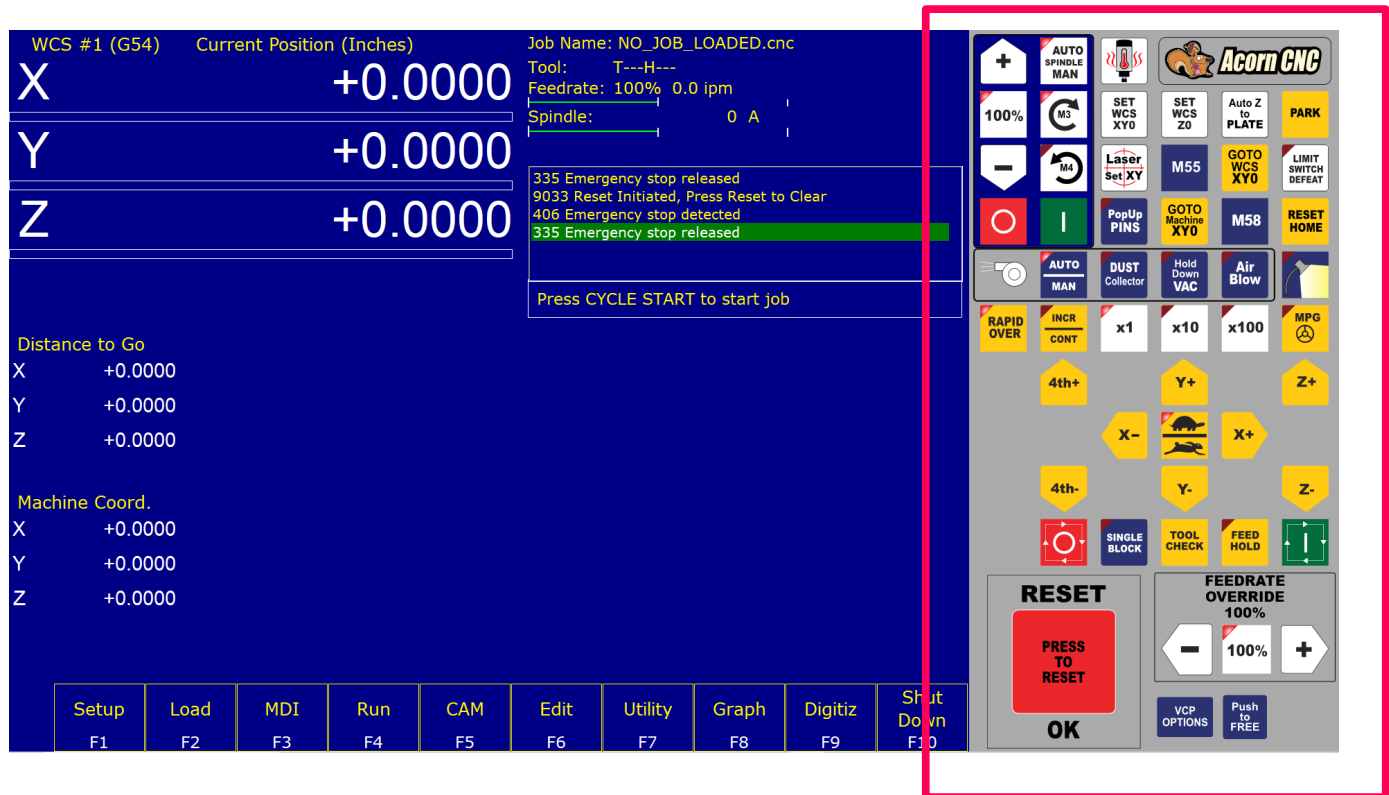

## 2.) PWM Output for Spindles and Lasers

- a.) 5 volt PWM output signal is on DB25 pin# 14. ( [https://en.wikipedia.org/wiki/Pulse-width\\_modulation](https://en.wikipedia.org/wiki/Pulse-width_modulation))
- b.) DB25 pin# 14 is Output 2
- c.) Output 2 is also connected to Relay 2 via the ribbon cable
- d.) If PWM output is used, Relay 2 must be disabled. See schematic to cut ribbon cable lead to Relay 2. see schematic S15049
- e.) PWM is based on 0-100 OR 0-1000 S command. User selects range 0-100 or 0-1000 in Acorn Wizard.
- f.) M37 turns ON Laser Output, M38 Turns Laser output OFF: M37 will activate Laser Enable, Laser Reset, and PWM Select. After .5s will turn off LaserReset. At this point the laser controller will look at the PWM signal from OUTPUT2. M38 will wait 30s to allow JTECH laser controller to cool, then performs a M95 /37 /38 to turn off both Laser Enable and PWMSelect.
- g.) PWM Velocity modulation feature adjusts the PWM output based on velocity of the machine tool so over-burning is avoided in the corners or turn arounds. G37 is used to turn ON and OFF PWM Velocity Modulation. G37 ON = PWM VM ON, G37 OFF = PWM VM OFF
- h.) Simple PWM controls are located in the Acorn Wizard. In addition to “manual PWM controls”, preset buttons for common Jtech configurations are present and have matching schematics. (S15049,S15056,S15057)

### PWM Setup

PWM Enable	<input checked="" type="checkbox"/> Yes
Base Frequency (Hz)	<input type="text" value="1000"/> (min value = 1, max value = 24,000)
Laser PWM S command range: 0-100 or 0-1000	<input type="checkbox"/> 0-100
PWM minimum S command power level to start Laser	<input type="text" value="5"/>
Inverse Output	<input type="checkbox"/> No

---

#### Common J Tech Laser Configuration Presets

Jtech Laser (Dedicated Laser Machine, No spindle motor)	<input type="checkbox"/> No
Jtech Laser with PWM BLDC spindle	<input type="checkbox"/> No
Jtech Laser with analog output AC spindle motor controlled by VFD	<input type="checkbox"/> No

## PWM related i/o added to the Wizard.

a.) PWM Output: The PWM signal itself. Can only be used on Output 2 (Output 2 of DB25 pin#14) Related cnc code is the S command.

b.) LaserEnable: Typically used in a safety interlock circuit, see Jtech schematic S15049 as an example. Related M codes. M37 - Enables Safety Interlock and Resets Laser. M38 - Disables Safety Interlock after a delay to allow component cool down.

c.) LaserReset: Momentary output to Reset Laser. Used to send a reset signal to the laser controller, see Jtech schematic S15049 as an example

d.) PWMSelect: Output to move PWM signal from Spindle to Laser. PWMSelect is used when the PWM signal is required to be sent to different devices. For example a machine that has both a Spindle Motor and a Laser that require PWM to run. PWM from output 2 is connected to the COM of the relay PWMSelect is assigned to. To use with Standard Layout, Spindle PWM should be connected to NC side of Relay and Laser should be connected to NO side of relay. When PWMSelect is deactivated, PWM is being sent to Spindle. When PWMSelect is activated, the PWM signal is being sent to laser. Follow Schematic J-TECH Photonics Laser, BLDC Spindle Control #S15057

The screenshot shows the 'Router CNC Control Configuration Wizard' interface. On the left, a navigation tree includes sections for Primary System, Axis, Spindle, Touch Devices, Control Peripheral, DB25 Connector, and Preferences. The 'Output Definitions' sub-section under Primary System is selected. The main area displays a list of output functions, with 'LaserEnable', 'PWMSelect', 'LaserReset', and 'PWM Output' highlighted in a red box. To the right, a table titled 'Acorn Integrated Outputs 1-8' shows a mapping of output numbers to their definitions.

	Definition
1 OUT1	OUTPUT1
2 OUT2	OUTPUT2
3 OUT3	ChargePump
4 OUT4	OUTPUT4
5 OUT5	OUTPUT5
6 OUT6	OUTPUT6
7 OUT7	OUTPUT7
8 OUT8	OUTPUT8

Click and Drag an Output function definition from list to the Output number Definition box to assign a function to an output

## CNC12 Acorn Version v4.62

- Fixed issue that would rarely and intermittently result in erroneous limit tripped messages introduced in rev12.
- Fixed issue when keyboard jogging is enabled you cant navigate the config menu.
- Eliminated auto insertion of suggested max rates in the Wizard axis config page, (out of range max rate warning message is still present).
- Fixed lathe tool auto measure X offset for ID Turn, ID Custom, ID Groove, FFace Turn, and FFace Bore
- Added an option in the Wizard and CNC12 to turn off warning that states "check if probe is functioning correctly" (Parameter 410 )
- Added an escape button to DXF engraving menu

### rev 12 Improvements

- Added clean filter message but now allow users to set the frequency date that it appears in the Wizard can be disabled by entering 0 value. (sets parameter 421) Under CNC Control Preferences in Wizard.
- Added RPM\_Sensor Input for one pulse per revolution Spindle Speed indicator that uses an Input, typical use with Hall Effect sensors. (note: can not be used for threading, threading requires a spindle encoder, spindle encoder and RPM\_Sensor can not be used at the same time. If you have an encoder installed CNC12 reads the spindle speed from the encoder and the RPM\_Sensor is not necessary. RPM\_Sensor is for machines without a spindle encoder but the user wishes to have a true spindle RPM readout within CNC12 and displayed on the main screen. In the Wizard input definitions menu.
- Added the ability for users to set charge pump divider Value in the Wizard. Default value is 96 which is compatible with G540 and is automatically set when G540 is selected. A 0 value disables the Charge Pump. Note: Charge Pump output works only on Output 3 of the DB25 connector and can only be assigned to Output 3 in the Wizard output menu. Under Advanced menu in Wizard.
- Disabled keyboard jogging while in the F3 CNC12 configuration menu to eliminate keystroke conflicts.
- Added sample laser gcode files to nfiles\laser along with Laser alignment test files.
- Lathe: Added ability for users to choose the Default Lathe operating mode. Feed per minute (G98) or Feed per Revolution (G99) G99 requires a spindle encoder while G98 does not. Lathe Wizard Spindle setup menu.
- Increased beta count down timer message to start at 45 days
- Improved M44, "Auto Z to Plate" VCP button to read probing values set be the Wizard to reduce user initial setup steps.

### Fixes

- Fixed typo in the backing up of the cnc12 folder during install
- Fixed CNC12 not reflecting edited g-code until after restarting CNC12 or reloading the program
- Fixed Router Wizard VCP jog state on start up not taking.

## Notes from previous revs that are included in subsequent revisions as well.

### Fixes

- Fixed Chuck and Collet Logic not resetting correctly causing issues with spindle.
- Fixed Lathe gang / front / rear wizard setting not 'sticking'
- Fixed rear mount TT cycles bug
- Fixed UI issues with the preview gcode feature, like hiding it when going into the mdi and run job menus, and unhide it when going back to the main menu
- Fixed bug in the vcp were plc memory wasn't able to be used to set LED state
- Fixed saving issue for mill param 43 in the wizard
- Fixed problem with Skinning API CSR SetAngle and GetAngle functions which always failed
- Fixed issue on Mill and Router versions were if TT and Z-Ref is set you can't measure the Z axis in the part menu, because of an error message saying probe is not setup
- Fixed the part menu flashing if the probe is unplugged
- Fix for issue where a report could not be restored

### Improvements

- Created new "Router" VCP ,Wizard and CNC12
- added ZriHomingAll input to the Wizard
- added Beta software count down timer
- added ESC key to Probe Bore menu
- sorted all wizard inputs and output definitions alphabetically
- reworded the warning error for db25 disabling custom mapping to be more user friendly
- change name of low air pressure inputs to low pressure to eliminate the word Air as they can be used for any number of pressure sensors not just for air, functionality of the inputs are the same, just a name change
- name change of MPG macros from PLCmacro1,2,3,4 to MPGmacro1,2,3,4 functionality is same, just a name change
- implemented new DXF import library so DXF import in intercon is compatible with a wider variety of DXF files. Note: Intercon accepts line and acrs. Any DXF file with curves will not work with intercon, if your dxf file has curves, convert all curves to lines and arcs before importing into intercon.
- reactivated the "DXF in" feature of Intercon
- Implemented FootPedal Input for Chuck Open/Close
- Added a category for Safety related PLC Functions in Input and Output Definition pages in the Wizard
- Added a notification during installation to backup current cnc12 dir for the user
- Added a warning message on the cnc12 main menu like the smoothing message, but to tell the user that m37 is active
- Acorn analog out 0-5 selection in Wizard and CNC12 parameter support for same
- WCS Table Lock Unlock check boxes beside WCS table in WCS menu
- improve Keyboard Jogging to eliminate keystroke conflicts in certain cnc12 menus
- Added PLC Function WorklightRouter
- Added a PWM setup page in the wizard
- Added J-TECH Related PLC Outputs and Macros for Router and Mill
- displaying the first 11 lines of code when you Load a G code Job.
- Gang tooling configuration selection in lathe wizard.
- Complete PWM output for Acorn via DB25 connector (for Laser power and DC motor speed controller command)
- Reference PLC Variables in G Code by Name
- Replace Wizard Rigid Tapping pop up window with a proper Wizard configuration page.
- Changed PLC Function RouterAirBlow to AirBlowNozzle
- added ability for keyboard jogging to be active when cnc12 starts. (users will not have to press Alt-J to activate keyboard jogging)
- change wording on Z part zero mill/router menu to remind users to enter the tool number they are using
- added sample laser files along with test pattern files to Mill and Router ..ncfiles\laser

### Note:

- G64 Smoothing is not compatible with PWM output for lasers. Do not use the G code smoothing feature and PWM Output at the same time for laser applications.

## Acorn CNC12 v4.5 release notes

- fixed vcp resizing dots disappearing bug
- fixed vcp options saving and loading bug
- rewrote how the VCP communicates with the PLC to be compatible with a upcoming windows 10 update.
- made improvements to VCP related to an upcoming microsoft win10 release
- made improvements to graphics flickering anomaly in probing menu when you unplug the probe and stay in the menu.
  
- Added "Custom VCP Skin Yes/NO" slider to CNC Control Preferences in the Wizard. Select Yes if you plan on customizing the VCP and the Wizard will not overwrite any or your modifications.
  
- Added Parameter 12 to fix Lathe Auto Tool Measure ID bore Z offset bug. Default setting should work for most users, if not change from 1 to 0 to flip the sign of the measurement so the proper value is calculated.
  
- Improvements to VCP base code to make it compatible with latest Windows 10 update.
  
- Added new feature "Dry Run" to Lathe. Basic testing has been performed, more testing is needed, please give it a go and report back!

### Dry Run operator notes: Acorn Lathe: Dry Run

- Dry Run is a Lathe feature where you can test run a program without material in the spindle.
  
- Dry Run mode gives you the ability to run the program in air to check that tool offsets are set up correctly before cutting material. NOTE: All tools in the program need to be set before running Dry Run.
  
- In Dry Run mode all G0, G1, G2, G3 moves are run at a preset feedrate of inches per minute (mm per minute) whether or not the program was written in feed per rev or feed per minute.
  
- In CNC12 parameter screen (F1 – Setup, F3 – Config (Enter password if required), F3 Parm, page to the next table to setup Parameter 128 and 129. Set parameter 128 to 61132, set parameter 129 to 15 for inches per minute or 380 for mm per minute or a feed rate that you feel comfortable running at for Dry Run.
  
- Spindle does run but can be turned off once the program starts by pressing the Red spindle off button on the VCP or the MPG. NOTE: The spindle does have to run for the Tapping cycle (G84) and the Threading cycles. The feed moves in the tapping cycle and the threading cycle will be at the programmed feed per rev at the programmed spindle speed if there is an encoder on the spindle. Have not tested this for a lathe with no encoder on the spindle.
  
- In Dry Run the feedrate override can be used to decrease the preset feed rate for Dry Run or increase the feedrate to the allow percentage override that is set in Wizard.
  
- In Dry Run like when running a program it is the operators responsibility to watch the moves to avoid a crash.
  
- If the tools will be close to the chuck it is suggested that Part Z0.0 be set a safe distance from the chuck on the first run and after making any changes to the program
  
- You can turn Dry Run on before doing a Run Search for a tool number, N number or line number. You can enter Run Search, enter the tool number, N number or line number and before pressing Cycle Start turn Dry Run on.
  
- If you are running a program you can not turn Dry Run on or off until the program has stopped by canceling or at a tool check.
  
- Dry Run on a manual tool change machine at a tool change by pressing Tool Check Dry Run can be turned on or off at a tool change. A lathe with a turret the program would have to have a program stop at the tool change then pressing Tool Check to turn Dry Run on or off.
  
- Lathe Auto Tool Measure bug for ID BORE X offset has been fixed.
  
- Lathe Copy G code from USB drive 913 error has been fixed.
  
- misc message improvements
  
- misc minor wizard UI/UX improvements
  
- User Editable VCP (VCP 2.0) see Users manual.

[https://www.centroidcnc.com/centroid\\_diy/downloads/centroid\\_vcp\\_users\\_manual.pdf](https://www.centroidcnc.com/centroid_diy/downloads/centroid_vcp_users_manual.pdf)

- Mill Pro License now includes all the menu driven Probing cycles and CSR
- Wizard axis labels only allow X,Y,Z or N for axis 1,2,3 for Mill. And Z,X or N for axis 1,2 for Lathe. (you can still label them in cnc12 config menu as normal)
- Machine Coordinates mini DRO added
- Wizard password protection added. Uses same password as CNC12 config menu.
- reworked Active G codes layout for easier UX
- Added Aux key assignment menu to the Wizard
- New Wizard stock inputs and outputs added
- Added vcp indicator light button functionality image swap based on a PLC input or memory location
- CNC12 UI Redesigns:
  - changed the ui of the run menu, active line of g code in bold, history gcode in white
  - changed up the active gcode
  - add images of the state of the probe in the probing menus
  - changed the spindle speed and feedrate line color green 0-100, orange 101,120, red 121-200%
- Fixed issue of users being able to set feedrate using G99 over the max rate of machine
- fixed probing menu showing upgrade to pro when user is upgraded to digitizing pro
- add the ability to use plc inputs for vcp button led state
- fixed AuxKeys page overwriting aux10key when axes pairing is enabled
- cnc12 can be closed by right clicking on taskbar (edited)
- added skin event numbers to wizard aux key configuration menu for clarity
- Fixed Logic for Outputs that were activated with both VCP and M-codes.
- Cleaned up some unused Memory Bits and incremented INP for Aux13-16 Keys by 1 to match Aux13-16 Key OUTs.
- Fixed VCP screen sizing issues with non 1920x1080 resolution screens
- Added Initialize\_T Logic to prevent Outputs from turning on and off during boot up.
- added various error codes to vcp
- fixed issue of g03 code has 2 axes and a angle tells users to upgrade to pro
- Fixed bug where the wrong minimum position increment was used when the control units of measure was not the same as the parsing mode (G20/G21).
- Added "Legacy" VCP for users who wish to use Custom PLC's from Versions 4.20.1 and earlier. Added Legacy versions of updated function buttons such as Rapid over and Brake Release.
- the wizard can now swap the new default vcp to the old legacy vcp skin with a custom plc program

## Changes, Fixes and Additions from previous version (v4.20)

- Fixed an issue with systest.cnc where it does not recognize if one of the axes (5-8) is a rotary and therefore allowed to have no travel limit.
- Fixed execution times for PLC programs displayed in live PLC diagnostics to be compatible with faster hardware. The displayed times were based upon a 400 MHz Blackfin CPU speed (older systems) and now work with the faster 528 MHz hardware.
- Change: any report\_\*.zip files that are placed into the extra-report-files folder will not be included in the report zip file. The extra-report-files folder is the place to put files that a user wants included in the report zip file that are not already included in a report, but it is inviting some users to store report zip files there by default, with the unintended consequence of making the report zip files grow increasingly larger. In addition, when choosing a location to save the report, choosing the extra-report-file folder or one of its subdirectories is not allowed and will result in a message prompt to choose another location.
- MPUCOMP/MPU: support for 128 timers in the PLC program, PLC Detective, and in G-code user variables #90001-#90128.
- Lathe: RTG will show a triangle tool tip for nose vectors 5 and 7 when using a turning type tool.
- Changes to optimize RTG/backplotting time= Faster Backplots!
- Lathe: fixed tool offset measuring bugs.
- Implemented the Proportional Coefficient Scale Algorithm which uses machine parameters 620-635. Parameters 620-627 specify a proportional constant (the P in PID control) for axes 1-8 and machine parameters 628-635 specify a max correction velocity in encoder counts per interrupt. If the proportional constant is non-zero, then the scale velocity is computed using the proportional constant multiplied by the scale error and is bounded to the max correction velocity. If the proportional constant is zero, then the scale velocity specified in the Scale Settings menu in CNC software is used. This feature may be helpful for systems that have large backlash amounts for which a set velocity reacts too slowly and raising the scale velocity to compensate results in instability. Note that a non-zero value for the fourth or fifth axis will override the dual velocity scale algorithm for these axes (see machine parameters 600-605).
- Added the ability to perform on-the-fly switching between fast and slow jog. This was to support a retrofit that had a jogging joystick. The joystick could be moved in four directions and would move slow at first but then it could be pushed further to go into a fast mode.
- Changed the wording for machine parameter 180 in the parameters menu and in the manual from "Clear Limit Switch Distance" to "Clear Home Switch Distance".
- Change: user variables #25024-#25026 (added in Rev2) have been moved to #25029-#25031 to resolve a future merge conflict.
- Added user variables #27801 - #27808 for position mode error correction values, the same that is in the PID Encoder Menu. There is also access in the PLC program via system variables SV\_POSITION\_MODE\_ERROR\_AXIS\_1-8.
- Added user variable #25026 to access lifetime spindle on time in floating point hours.
- Added user variable #25025 to access lifetime job in progress time in floating point hours.
- Added user variable #25024 to access lifetime power on time in floating point hours.
- Skinning API: Added function Tool.GetToolLibrary. See the Skinning API documentation for more information.
- SKinning API: Added function Job.ContinueExecution. See the Skinning API documentation for more information.

- Added machine parameter 440 (Stop for Jogging Continue Bit). A value of 0 is the standard behavior wherein we wait for CYCLE START or TOOL CHECK when at an M0/M200/M201 prompt (and M0 jogging is allowed) before continuing execution. A value of 1-255 will also continue execution when the system variable SV\_SKIN\_EVENT\_1 - 255 is set. A value of 256 will also continue execution after the Skinning API Job.ContinueExecution function call.
- Fixed Lathe spindle benchtest.cnc trying to write to a text file with the wrong (cncm) path.
- Fixed intermittent issue where the PLC non-volatile variables (SV\_NV\_Wx and SV\_NV\_FWx) were not getting saved.
- Change: to enable M0 jogging, parameter 10 (Macro M function handling) bit 5 (+32) must be set. Note that for servo controls, a trial code or Pro/Ultimate license is also required.
- A warning message is displayed and the job is stopped if trying to execute a G53 command in incremental (G91) mode.
- Lathe: moved the F9 Exit/CNC12 function key to F7 to prevent unintended exit from the CNC software when trying to use the F9 Tool Wear from the main menu (which can register as an F10 Shut/Down followed by an F9 Exit/CNC12 if one is not careful).
- Lathe Intercon: a tool with spindle direction of NSP (No SPindle) will be post with an M5, even if the Setup option "Stop spindle during tool change" is set to "No". More specifically, this fixed an issue using a bar puller tool where the spindle would keep turning according to the previous tool's spindle direction.
- Added the PLC system variable bits SV\_HOME\_SET\_AXIS\_1 - SV\_HOME\_SET\_AXIS\_8. These are for the PLC to access the individual home set state. There are some short-comings of this implementation right now. For example, if CNC software un-homes an axis, that does not get reflected, but we have G-code user variables to access that information if needed. The way they behave now is that they get set when the MPU receives a command to set home for an axis and they stay set until MPU reboot.
- Change: if the USB MPG feature is not unlocked, then do not force parameter 218 (USB MPG Options) to zero. This change will allow the USB MPG to start working after a trial code or license re-enables it without requiring the user to set parameter 218 again.
- Added the PLC system variable bits SV\_ENCODER\_INDEX\_PULSE\_1 - SV\_ENCODER\_INDEX\_PULSE\_21 that return the status of the encoder index pulse signals.
- Added the PLC system variable bits SV\_LATCHED\_ENCODER\_INDEX\_PULSE\_1 - SV\_LATCHED\_ENCODER\_INDEX\_PULSE\_21. These variables get set when an index pulse occurs and remain set until they are read by the PLC program.
- Added the PLC system variable bits SV\_SCALE\_INITIALIZED\_1 - SV\_SCALE\_INITIALIZED\_8 that are set once the axis scale is initialized, which occurs after the axis is homed. It is also normal for a scale to become uninitialized when starting a homing command. There is also user variable access via #27601 - #27608.
- Added the PLC system variable bits SV\_SCALE\_ENABLED\_1 - SV\_SCALE\_ENABLED\_8 that reflect when the scale is enabled, the same that is viewed in the Scale menu of CNC software. There is also user variable access via #27701 - #27708.
- Added two 32-bit integer word PLC system variables, SV\_ENCODER\_DIFF\_BITS and SV\_ENCODER\_QUAD\_BITS, that each have a bit for each encoder (up to 21) to indicate whether the encoder has a differential or quadrature error.
- Change: when using an absolute motor encoder with an incremental scale encoder and home is set, the scale is set to the equivalent motor position. While this will prevent a slow drift away after home is set, which is what happens if you set the scale to zero, such a machine configuration should be reconsidered due to repeatability issues.
- Changed the behavior of the PLC system variables SV\_DAC\_OUTPUT\_ENABLE\_x and SV\_DAC\_OUTPUT\_VALUE\_x so that if the DAC output is enabled and the value corresponds to a zero output, the axis is disabled.

- Fixed issue where laser tables/lash was not working correctly if the axis was configured for an absolute encoder.
- Lathe change: when the spindle encoder counts (P34) or spindle axis (P35) is changed, the updated information is sent to the MPU. This change was to support an application where the updated information was needed without requiring a restart.
- Added the M291 command to reset the MPG offset. This works for the first MPG and the Z axis, though we expect to add the capability to use it for another axis and a second or third MPG.
- Changed the bound on the maximum MPG encoder input from 15 to 21. This should allow MPG encoder input to be connected to ENCEXP/ENCEXP2 hardware, which have encoder inputs that are mapped to values 16 – 21.

#### **v4.20 release notes**

-Added machine parameter 180 (Clear Limit Switch Distance). This parameter specifies the distance to move before generating an error when looking for the limit switch to be cleared during a homing (M91/M92) command. A value of zero will result in a default setting of using a distance of 0.5 inches or one motor revolution, whichever is greater. This distance only applies to a linear axis. If the axis is rotary, a distance of 45 degrees is used regardless of the parameter value.

-Added support for new Intercon KEYLOK USB dongles.

-VCP2 will try to determine the location of the word named "FinalFeedOverride\_W" used in the PLC program. If it is found to be using W1 - W88, then it will use this word value for determining feedrate override. This change should make VCP2 compatible with existing PLC programs written for VCP1 that used W4 without requiring a change to the PLC program. VCP2 programs use W31.

-Fixed some display anomalies where previous G-code lines were not being erased and/or the MDI "Block?" prompt was not displaying correctly in some combinations of Active G-code display and DRO property settings.

#### **v4.18 release notes**

- Reactivated the DXF Import feature in Intercon with improved DXF import library

- Fixed issue where axis pairing was not available under any conditions.

- Fixed issue where laser measurement was not working regardless of license type or trial code.

- Fixed issue where the prompt "Press CYCLE START to continue" is not displayed when executing an M0 command if M0 jogging is available. When M0 jogging is enabled, the message "Press CYCLE START to continue (jogging enabled)" is now displayed.

- Fixed issue where the 4th axis was being set to 'N' (disabling it) when entering the Motor Parameters menu. It does prompt for changes on exit, so one can discard those changes if they were just going into the menu to look at values. Otherwise, the workaround would be to make sure you set the label again before saving changes.

- Re-enabled the setting of P500 = 1 to allow G43.3 and G43.4 to remain active when exiting MDI or running job.

- Fixed bug in the VCP where PLC memory wasn't able to be used to set LED state.

You will have to reset any MPG related parameters, see the New Parameters Guide attached to the instructions PDF below

#### **v4.16 Release Notes**

Software levels, plug-ins, and trial codes to replace unlocks and demo codes.

PLC Installer: changed the text on two buttons, one from "New Install" to "Install - and overwrite existing machine configuration" and the other from "Update Existing" to "Install - and keep the existing machine configuration".

Replaced the machine home bitmap with the same one used on Acorn.

Change to allow the half-width touch screen ESC key to be drawn on the exit menu if the user entered the menu via the F12 key from the main menu.

Mill/Lathe Emulator: changed to run as if there is a demo unlock.

Mill/Lathe Emulator: fixed issue where upon entering the Options menu, the ESC key was not drawn and the F-keys would sometimes not get erased.

Virtual Control Panel 2.0 (VCP2) implemented.

The Virtual Control Panel (VCP2) is installed with demo software and can be launched, though it does not have any useful functionality other than to appear.

Change so that when a fatal exception occurs the logging files are closed.

Change: when a report is made, all files in the extra-report-files folder are included in the report. An empty extra-report-files folder is created if needed when the installer (setup.exe) is run.

Added check to see that the probe is untripped before it makes the slow measuring move (in the case of Auto Measure).

Implemented the park.mac G-code macro that can be run when parking the machine if machine parameter 413 (Park Macro) is set to 1.

Added new CncSkinning commands: GetToolBin, GetToolBinSetToolInfo, SetBinNumber, SetCoolant, SetToolOffsetDiameter, SetToolOffsetHeight, SetSpindleDirection, SetSpindleSpeed, SetToolIDNumber, SetToolHNumber.

Implemented access to the analog outputs on an OpticDirect using the system variables

SV\_DAC\_OUTPUT\_ENABLE\_1-8 to enable and SV\_DAC\_OUTPUT\_VALUE\_1-8 to set the value.

Changed the distance that we allow during the homing process when backing off the limit switch from 0.25 inches to 0.5 inches. In the future, we may add parameters to control this distance or take into account the starting position.

Lathe Intercon: added a bit 3 (Lathe Intercon Post Tool Offset Bit) to parameter 3 (Modal Tool and Height Offset Control) that will post out the tool offset as part of a tool change. Normally, the tool change procedure would post out a zero offset first, but this can cause unwanted speed-up of the spindle in constant surface speed mode when a machine is configured with X ref set at centerline. Although a machine could be configured differently, it imposes an unnecessary way of doing what is otherwise considered a normal setup.

Adjusted the size of the PLC Installer program from 800x600 to 1024x768.

Added new Jog Panel Type option in the Control Configuration Screen for the Virtual Control Panel.

Selecting "Virtual" for the option will set P219 to 1 and launch the VCP application. Unselecting "Virtual" will set P219 to 0 and kill the VCP application.

When a report fails to install CNC12 now will display a message with the file that the installation failed on.

Skinning: Updated/refactored skinning user controls.

You can now initialize User String Variables (#300-#399) to an empty string. (i.e. #300 = "")

Increased the time to wait for the Mpg Client to start up from 1 to 2 seconds.

Added new system variable "SV\_USB\_MPG\_POWER".

Added support for the wireless mpg to send a "Powered off" state when it is powered off with the silver power button.

Added default configuration files for MillDemo and LatheDemo to remove warning on fresh installs.

Added '-o' command-line argument for the plc compiler that outputs the definitions without compiling the program.

Modified Skinning.SetMachineParamter function to send changed parameter to PLC

Fixes

Fixed issue where the half-width ESC was not drawn when entering the Probe Bore screen and P154 (Touch Screen Options) was set to enable it.

Fixed a crash when executing a line that had an "M225" command without any additional arguments.

Fixed problem with Skinning API CSR SetAngle and GetAngle functions which always failed. Lathe: fixed problems with measuring tools in some certain cases.

Fixed issue where the software appears to be frozen at startup displaying a blue screen with the status window blacked out and no message being displayed. This occurs when first starting software and either there is no connection to the MPU or the MPU has not had enough time to initialize.

Lathe: fixed issue where the enter key became unresponsive while editing a field in the Tool Library.

Lathe: fixed display anomaly where the Setup menu did not reappear after exiting the Tool Library.

Fixed an issue with the Skinning API AddMessage function where it was inserting an extra space at the beginning, leaving a couple of extra characters at the end, and was not logging numbered messages.

Fixed a load meter display issue in RTG where it did not use the PLC reported values (SV\_METER\_x) when configured to do so via machine parameter 57 (Axis Bitmap for Generic Meter).

Fixed a display anomaly where the right hand side of the status display (Program #, Part Cnt, Part# and Time display) would disappear after an Aux key is pressed. The reset of the status window (clearing the right hand side) is intended only to happen when an Aux key is assigned a function (like a one-shot Intercon cycle) using machine parameters 188-199.

Fixed display anomaly where the upper viewports did not re-appear after exiting the Pid Config menu.

Fixed bug where subprograms and macros unlock was needed for an M26, M29 on lathe, M91, M92, M93, M105, M106, M122, or M124 command.

Fixed a bug that was causing the auto tool measurement for an ID type tool to be incorrect.

Fixed a bug relating to G53 command with L parameter not working on lathe. The software now changes the machine state to Feed Per Minute, does the move, then restores the state.

Skinning: Fixed broken WcsGetActive command and the WCS skinning commands. The WCS command router was never added to the routes map, so any call to the WCS skinning commands would have always failed.

Skinning: Fixed broken GetToolNumber command.

Skinning: Fixed broken GetCurrentHeightOffsetNumber command.

Skinning: Fixed broken GetActiveGCodes command.

Fixed a bug in the Skinning pipe that would cause the skinning call GetDoubleWordValue to fail.

Fixed issue where SV\_PROGRAM\_RUNNING was not being turned on when performing a Find Home/Switch operation from the "Find Home" menu.

Fixed bug where turning off the Wireless Mpg when the software is off caused the software to think the Wireless Mpg was on when it started back up again.

Fixed a software crash that would occur when a macro was called recursively. This only happened for macros 3-5 and 7-11. (i.e. calling M3 within M3)

Active G Codes will now correctly display what measurement mode you are in when entering MDI or running a job.

Fixed issue where the status window did not update the Fast/Slow, Incr/Cont, and x1, x10, x100, indicators properly when keyboard jogging was enabled.

Fixed issue where probing/homing commands could appear to hang. It is more likely to occur with very slow probing rates or lower resolution (encoder counts per unit) axes.

Fixed issue with the F2 Paste Position function where it would paste in an axis labeled 'N' (for the spindle axis). Also changed the paste position to not display an axis that was marked hidden in the axis properties.

Lathe: fixed issue where loading a job from a USB stick or network location with file caching turned on did not work.

Fixed bug in InputInversion Skinning function related to param saving

Lathe: fixed parameters screen and Operator's Manual to reflect the correct parameter (404) for Active G-codes display for a Servo Lathe system.

## V4.14 release notes

Changed report generation to include a file called tasklist.txt that contains the list of running processes at the time the report was generated. This can be used to determine, among other things, if the windows update defeater is running.

Implemented support for WMPG-4. Machine parameter 411 (MPG Type) is used to select between CWP-4 (value of 0) and WMPG-4 (value of 1).

Changed the tolerance for a scale error on a linear axis from 0.025 inches to 0.100 inches.

For parameter 401 (Forget last job on load), a value of 0 will now remember the last job you had loaded when you shutdown. A value of 1 will forget it and load "no\_job\_loaded.cnc".

Eliminated "Axis \_ not homed" messages.

The M91/M92 commands have been modified so that when moving back off the home switch, the distance moved for a linear axis will be a quarter inch or one motor rev, whichever is greater.

Added FIX and FUP tokens to G-Code parser for rounding values down and up, respectively.

When homing fails due to a home switch not clearing, the message has been changed from "325 Limit: job cancelled" to "Switch failed to clear, homing cycle cancelled".

Active G-codes available on LATHE.

Blocked ALT\_J from being used when ALT\_I is already turned on.

Added the system directory to reports. It will be located in the urf.zip folder.

Added the ability to export the tool library as a text (TXT) file or as a comma-separated-values (CSV) file.

The ability to press Cycle Start in the Run Menu is now governed by parameter 400.

Parameters 400 - 899 are now visible in the parameters menu.

Added Run->Search history tracking feature. Works like MDI history.

Re-enabled the Cycle Start button in the Run Menu.

Changed sample nfiles and intercon programs shipped with CNC12 Servo to match those of Acorn.

Implemented a per-axis power on timer for velocity/torque mode drives.

Improved Arc motion for systems with low steps/counts per inch resolution commonly found on DIY Hobby machine tools

### Fixes

Fixed crash importing unlocks when the import file had extra blank lines at the end of the file.

Fixed issue with VCP jogging where it could become unresponsive intermittently when the MPG is enabled (axis select not off) with continuous jogging and a VCP jog is started before the previous one completes. After jogging became unresponsive, a RESET or entering MDI would allow jogging commands to resume normally.

Fixed issue where a resume after a TOOL CHECK would not work if the job was loaded from a USB stick or network location and the file load options were set to copy to the hard drive. A workaround for this problem is to reload the same job from the hard drive location.

Fixed bug where (job.xml) was not being loaded.

Fixed display issue when displaying unlock options where some were missing. This would occur when P386 = 0 (hiding display of five axis related unlocks).

Fixed crash related to saving/posting Intercon programs that had Comment or Insert (M&G code) operations. This would happen when loading/converting Intercon programs from previous versions (before 4.12). Previous versions had a smaller (around 40 characters) limitation for the number of characters for a comment or insert M&G operation. Version 4.12 extended the limit to around 255 characters, but Intercon did not allow the increased size to be used for the comment operation, and this has now been fixed. In addition, there is a fix for a display anomaly where the Intercon operation list field would extend past the vertical line separator for Insert M&G Code operations.

Fixed some issues sizing the CNC12 main window when the --adjustfortaskbar option is given and there are different sized monitors.

Fixed some issues with the VCP sizing correctly when there are different sized monitors.

Fixed a message bug that asked the user to connect a tool touch off when they were measuring a probe.

Ported a fix from Acorn: Fixed a display bug where running a job with rtg on while using the alt i screen cut off the display of rtg graphing.

Fixed a bug with state.GetSpindleSpeed skinning API function. The function will now return what is displayed in the Status Window.

Fixed bug in MDI Paste Position function where it would print the wrong axis labels.

Fixed bug where tool check would fail with message ("B-angle too steep to tool check") even if the fifth axis was not a rotary axis.

Fixed issues where accel times greater than one second were not always being respected. The problems could appear with arc moves or a series of other short segment moves when smoothing was turned off.

Fixed bug where probe jog rate values would not convert from inches to metric and vice versa.

Fixed issue where a DEFINE statement would cause an exception unless it contained the semi colon character (introduced with fix from R8703).

Fixed minor bug in active G-codes where it would show up over homing message if ALT+I was pressed during homing message being displayed.

Fixed bug where G-codes display would go behind the active g codes viewport whenever Mini DRO was not turned on.

Fixed bug where setting parameter 401 (the parameter to remember last job loaded on startup) causes the machine to think that it is not homed.

Fixed bugs in Virtual Control Panel: 1) where focus was not returning to CNC12 on startup, and 2) where VCP was not displaying correctly on a monitor "above" another monitor.

Fixed VCP issue where the 'l' in SPINDLE and MOTION vertical text was not on a separate line.

Fixed issue writing travel limit user variables.

Fixed bug where pressing F9 at main screen could cause Active-G-Codes display to appear overtop of the message that the machine must be homed.

### **v3.16 release notes.**

Added a "Compound canned cycle error" that occurs if trying to execute more than one compound canned cycle without an intervening G180 to cancel the compound cycle, since undesired movement between cycles can occur otherwise. The compound canned cycles are G173, G174, G176, G181, G182, G183, G184, G185, and G189.

Updated the keyboard jog panel bitmaps for lathe and mill and added higher resolution versions, suffixed with "\_hi", that are used for widescreen aspect ratios.

Added a message "410 %c axis(%d) OpticDirect C8 error" if the OpticDirect hardware reports a code eight error or if the MPU11 firmware detects a change in position of more than 314 counts for a position mode axis. The way to distinguish between software or hardware is to look at the OpticDirect drive LED- if it is a flashing eight, then it was hardware detected. Note that OpticDirect also has a new version (10) that changes how the code eight error is implemented in that it also uses a 314 count change (previous versions were using a 512 count tolerance).

Modified several menu screens so that the loaded job will not run when the Cycle Start button is pressed on those screens.

The PID encoder menu has an added column to show the total amount of standoff error correction that is being applied for each axis. A significant non-zero value here indicates that there have been significant standoff errors detected and that MPU11 is compensating for them.

Added a snapshot of the Pid Encoder Menu to the report file to aid in system troubleshooting.

Changed the way files are closed so as to reduce the likelihood of getting file corruption after abrupt power loss, especially in the tool library files since they are being written whenever a job stops, including on the exit of an MDI prompt.

Changed the spindle feed forward algorithm to use a delay based upon the maximum delay of the 1st and 3rd axes (X and Z on a Mill), which will alleviate Mill rigid tapping issues on precision mode systems when other axes (like Y and U on a five axis system) have much higher delay times.

Changed some of the timers used in CNC11 so that they are not affected by changes to the date and/or time. Specifically, these changes were made to fix a "452 PC Receive Data Error" that can happen when the time changes, such as when a Windows PC is set to automatically update the time from the internet, and said update results in a couple of seconds change to the time.

Changes to allow G10 codes to change machine parameter 6 (Auto Tool Changer Installed), machine parameter 160 (Enhanced ATC), and machine parameter 161 (ATC Maximum Tool Bins).

Implemented precision mode standoff error correction. There are two parameters that control the correction. One is machine parameter 261 (Precision Mode Standoff Tolerance Percentage) which indicates the percentage of the motor encoder counts per revolution for which standoff error must exceed before any correction is made. Setting P261 to zero disables standoff error correction. The second parameter is machine parameter 262 (Precision Mode Standoff Delay Time) which indicates how long in seconds that an axis must be at rest (no change in expected position) continuously before a correction is made. Suggested settings are P261 = 0.01 and P262 = 0.1.

MPG encoder errors are now reported in the status window as "412 MPGx encoder error", where x can be 1, 2, or 3. The warning can be ignored via machine parameter 333 (Disable differential encoder error messages) setting. Note that MPG encoder errors are never considered faults that will stop a running job. Also, many systems have shipped with machine parameter 348 (MPG 1 Encoder Input) set to 15, even if no MPG was connected. As a result, an upgrade to v3.16 may start displaying MPG Encoder Errors, and changing P348 to zero will be required to eliminate the warning.

Optional stops are not turned off automatically at the end of the job.

Removed options and/or references to loading files from floppy.

The language.msg file has translations for Polish.

Added support for M115/M116/M125/M126 commands when using paired axes. Consequently, most of the probing cycles will now work with paired axes. Also, when setting part zero for an axis that is a paired master, the paired slave position is set the same so that the DRO will show the same positions. Note that there is still no support for grid digitizing when using paired axes.

Modified the M224 command to allow 12 lines, fixed a crash that was happening when displaying more than eight lines, and fixed another anomaly with incorrect output.

The Control Configuration display has been changed to allow a longer "Remote Drive & Directory" to be displayed.

The report text file now includes a snapshot of the PLC timing statistics and a listing of the scale settings and PWM parameters.

Implemented changes to reports and file backups. A report or file backup (cnc\_backup) now includes, as part of the filename, the system id along with date and time stamp. Consequently, when restoring a report or cnc file backup, a choose file selection is made instead of a choose directory selection. When restoring a report, the system id encoded in the filename is checked against the system id of the running system and prompts are displayed if there is a difference. If restoring an older report.zip file, there is a system id check against the system id parsed out of the report.txt inside the report.zip. Also, when generating a report, the report text file is not copied along with the zip file, although it is still present inside the zip file. The automatic weekly report generation will keep the last ten report zip files in the reportbackup directory.

The option "M0 Jogging" now appears in the Software Add-ons screen (F7 Utility -> F8 Options). This add-on option was previously available for unlock, but was hidden from this screen.

Changed the minimum constraints to zero on machine parameter 365 (Drive Power On Delay) if machine parameter 256 (Drive Mode) is not set for precision mode. This change was intended to fix a jerk or bang on torque/velocity mode systems when the MPG handwheel commands movement for an axis that was powered off.

Mill: added machine parameter 136 "G76 Fine Bore Retract Angle" to specify the angle (0 to 359 in degrees) of the retraction. A setting of zero corresponds to a retraction in the Y+ direction, so a default value of zero will not alter the behavior of existing programs.

Intercon Mill: Implemented support for G76 Fine Bore canned cycle by adding a new toggle field ("Bore Tool Type") to the existing Bore operation. This new field can be toggled to either "Standard", which selects the default old behaviour, or to "Single Point", which generates the G76 in the posted G-code file. If this new field is toggled to "Single Point" the Bore operation UI will expose an additional field ("Retract Shift Y") so that the user can enter a shift amount for the "pull away" move that the G76 canned cycle does at the bottom of the bore hole.

Drag Plot should now work for velocity/position mode axes provided that the PLC program is reporting load using SV\_METER\_x system variables. The PLC program should report a value from -100.0 to +100.0 in SV\_METER\_x. CNC11 has been modified to use the absolute value of SV\_METER\_x for load meter display, with Drag Plot using the signed value.

Lathe: The "Restart Program" action of the default M30 is now selectable. Parameter 2 bit 6 (value 64) selects whether or not the default M30 will act like a default M2 (Restart Program). If set on, the default M30 will be equivalent to the default M2.

Unlocks can be imported from a file in the Software Add-ons menu. The file should be the same that is generated by the keylock application "Save Info" function.

The setup.exe installer does not give an option to install WinPcap, which is needed for the PLC Detective to function properly. WinPcap is now installed silently if the Mill or Lathe install is selected.

Updated the Windows Sentinel Protection Installer to v7.6.8. This installer is silently called when installing demo software.

The Utility Menu removed any mention of the Model name/number.

Mill Offset Library Menu: F4 Batch Measure now has the same check for TT-1 being plugged in as the single-tool F3 Auto Measure. Previously the F3 Batch Measure lacked this check and thus resulted in TT-2 crashes/smashes.

Changed the behavior of rigid tapping so that axes stay locked to the spindle at the bottom of the tap hole. Previously, the axes were not locked at the bottom of the hole between the time the spindle was detected as not moving and the issuing of the spindle reverse command since it was assumed there would be no spindle movement. However, it was possible for an unstable spindle drive to generate movement during this brief time and result in an unsatisfactory cut.

Added support for AC/DC drive RPM mode so the AC/DC drive can act as a spindle drive or C axis for brushless or DC motors. See the PLC section for system variables used with this feature.

Lathe: G71/G72 Profile Stock Removal cycles have optimized retraction moves.

Lathe: Added machine parameter 243 to control threading: Bit 1 (value 2) suppresses wait for index pulse, Bit 2 (value 4) permits spindle override during threading. These 2 options are analogous to the options available in P36 (Rigid Tapping options).

Added support for adjusting MPU11 clock settings for higher performance, which may be needed to support features added in this release. One way to check if increased performance is needed is to go to the Utility Menu and choose the F9 Logs followed by F4 MPU11. This will display an MPU11 Status window and about ten lines down in the center of the window is a count of "Interrupts". If this count indicates more than a few occurring, is an indication that higher performance is needed. The higher performance settings are accessed in the User Maintenance menu under the F3 MPU11 Speed function key. A plain F3 will prompt for a 400MHz clock setting (normal performance) and using ALT+F3 will prompt for a 528MHz clock setting (higher performance). MPU11 will report the current setting in the debug\_dump0.txt file on the line that reports feature bits. If the low bit of the feature bits is set, then the clock setting being used is 528MHz. In general, higher performance settings for the MPU11 are not needed for systems with only three axes.

Changes to allow viewing of the Jog Parameters and Motor Parameters when not in supervisor mode.

Several changes to enhance touchscreen support. One change is machine parameter 154 "Touch Screen Options". If this parameter is set to 1, then a half-width ESC key is displayed in most menus so there is a means of exiting the menu without using the keyboard. Most of the menus have been reworked to more fully support touch.

The generated report.txt file also lists the Machine Parameters (P0 to P999) one per line along with its description. This will make it easier to do a file compare between two report.txt files.

Mill: For machines with an ATC (P6=1) the default Tool Number in the Z Part 0 Setup Menu will be the currently active H offset number (or T number if H is invalid). This is to help prevent the operator mistake of neglecting to change the Tool Number field away from its default of 0, which would cause the Z part 0 to be set without any tool height offset applied.

Mill Intercon: Changed the Clearance Height Abs/Inc mode in subprograms (Repeat/Mirror/Rotate/Depth Repeat) to default to INCremental on newly inserted operations. Also the Clearance Height default values for these newly inserted subprogram operations have been separated from the Clearance Height default values of Drill/Tap/Bore/Thread Mill/Cleanout. This is an effort to prevent crashes due to 5-axis machine operators not seeing that the Clearance Height on newly inserted subprogram operations were set to Absolute.

Added a command line argument --adjustfortaskbar that will adjust the size of the CNC11 window to account for the taskbar. The adjustment works for the primary display when the taskbar is positioned at the bottom of the screen. This change is intended to help support touch screen control when no physical keyboard is present as it allows the on-screen or virtual keyboard to be minimized/restored from the taskbar.

Changed the main screen operator alert of missing/default config files to appear only once per boot-up.

Implemented accel/decel for Mill rigid tapping and Lathe threading moves (G32, G76, and G92). This change can reduce "banging" on such moves. This feature is controlled through machine parameter 240 "Accel/Decel distance for Rigid Tapping", machine parameter 241 (Accel/Decel rotational step size (in degrees) for Rigid Tapping), and for lathe, machine parameter 242 (Minimum Angle Threshold for application of Accel/decel in Threading moves). A good starting point for Mill rigid tapping would be P240 = 0.1 and P241 = 10. This feature can be disabled by setting machine parameter 240 to -1.0.

#### General Fixes

Corrected the help message in backplot from "use the + and - keys to control the redraw speed" to "use the CTRL+ and CTRL- keys to control the redraw speed".

Fixed issue in the User Maintenance Lash menu where validation was incorrect because it was not allowing negative values when screw compensation was turned on.

Fixed issue with cncfcgutilw.exe where it was not displaying axis labels when called with the -dw option. Also, replaced the text of some output messages to refer to cncfcgutilw.exe instead of the old CNC10CONV.

Fixed issue where the F1 Next axis command in the Power Feed menus was not working.

Fixed an issue where jogging could be allowed even though the limit switches for an axis were tripped. As a consequence of the fix, no jogging in the direction of the tripped limit is allowed. In some cases of mis-wiring and/or improper limit switch settings, this change may make it more difficult to jog off a limit and may require an operator to zero out limit switch numbers or invert the inputs, which is easy with SV\_ENABLE\_IO\_OVERRIDE support in the PLC program. Another necessary condition for this anomaly to occur was that the MPG was enabled and the selected axis was the one having the limits tripped.

Lathe: fixed the wording of the display prompt when setting X Diameter/Radius reference.

Mill: fixed a crash that could occur in Intercon when posting or graphing a program that contained a sub-program repeat specifying the same start and end block. In the particular case investigated, the repeated operation was a tool change operation, but there are other operations that would also lead to a crash. Note that a sub-program repeat of a tool change operation has no real practical use, but the fix may help a hapless Intercon programmer.

Lathe: fixed the cncfcgutilw.exe not working for Lathe or Lathe Demo installs.

Fixed intermittent erroneous position errors that could occur at the end of a move if the MPG is on.

Fixed M290 command (used in Lathe Wheel digitizing) inserting unwanted characters.

Fixed an issue with MPG that could cause a position error. The error was manifested in two ways: one was getting a position error after turning the MPG selector knob and the other was getting a position error after a jog movement ended. A necessary but not sufficient condition for the problem to occur is changing the MPG selector knob when E-stop is engaged.

Fixed a crash that was happening when displaying more than eight lines in an M224 command.

Fixed issue when generating the output of the control configuration in the report.txt file where the output of the remote drive directory was overrunning the next line of output.

Fixed an issue where stopping a laser run did not re-enable the override controls.

Fixed issue with axis max rate limiting where if an axis was an OpticDirect drive, it was limited to 300 counts/interrupt even though it may be in velocity/torque mode.

Fixed issue with axis max rate limiting where the rate limiting did not properly bound (to 300 counts/interrupt) an Oak drive axis that was in precision mode, i.e., connected to an OpticDirect.

Fixed a bug in CNC backup restoration where it could fail if trying to restore a file for which the directory did not exist.

Fixed OPTIC4 simulated tach output being broken for all axes except the first one.

Lathe Intercon: Fixed bug in Turning/Facing operation in the criteria for eliminating cut passes. Before the bug fix, it was possible for cut passes (specified by Depth of Cut) to be erroneously eliminated if the magnitude difference between the starting depth and the negative of the ending depth was less than the specified Depth of Cut.

Mill Intercon: fixed issue with the frame operation where if the Inside/Outside rect frame type is set to corner position type and then one toggles to the circular frame type, then the X and Y center fields are not shown.

Mill: Fixed Run-Time Graphics bug where the animated cutter and tool path trail would be misaligned from the greyed-out background tool path if the CSR and/or de-Skew display options are turned on for Run-Time Graphics. (CSR display option is P150 bit 1, and de-Skew display option is P150 bit 3.)

Lathe: Fixed misalignments in Run Time Graphics, especially on the grooving tool.

Fixed anomaly where the Alt-I live PLC I/O was erasing the F-keys of the menu from which it was invoked.

Fixed issue with repeated G76 fine bore (single point) drilling cycles where motion could be halted at the start of the cycle waiting for the spindle to get up to speed.

Fixed bug where negative Kg values were not sent correctly to the legacy AC (SD) drive.

Fixed a minor backplot graphics anomaly on the greyed-out original uncomped segment when cutter comp was turned on.

Lathe: Fix for feedrate override affecting threading cycles.

Fixed software lockup / out-of-memory error when axis four or higher was moved while cutter comp (G41/G42) was active.

Fixed some file filter specifications for the Windows file open dialogs, which fixes some cases where a file should have matched the wildcard but was not being displayed.

Modified the start.bat file to resolved issues with Windows 10 startup where CNC11 did not have input focus.

Fixed a crash in scroll bar enabled menus that occurred if the supposedly out-of-focus scroll bar was moved while a message dialogue box was actively being displayed and processed in the foreground.

Five Axis Changes and Fixes

Created machine parameter 32 (Autonomous Digitizing Offset Files) to determine which output files to keep after an autonomous digitizing job. The following bit values are used:

+1 Raw Centerline Data

+2 Clean Centerline Data

+4 Centerline FLow Splines

+8 Offset Data

+16 Spline Offset Data

+32 Spline Offset Flow Splines

+64 Offset Plus Flow

Fixed issue in autonomous digitizing where the interpolated line and curve plane fills were not correct when the difference between the start and end A angle exceeded 180 degrees.

Added the ability to perform an engine block operation on a list of cylinders, rather than restricting the option to one or all cylinders.

Added a 'Zero X Ref' button to engine block details page 3. This button takes the value of machine parameter 380 and assigns it to G55 X.

Added a dwell field to the boring cycle in the engine block software.

Added a 'Y Offset' position to the surfacing cycle in the engine block software.

Modified the main cap cycle in the engine block software so that 'Spot Face' is optional.

Added the ability to hone clearance both directions (left and right) in the boring cycle of the engine block software.

Updated the engine block probe\_deck.cnc file that fixes a hard coded clearance amount.

Updated the engine block database file.

Changes for autonomous digitizing to work for metric unit settings.

Changes to the autonomous digitizing offset surface algorithm.

Fixed issue with rigid tapping using G184 on an articulated head machine with a B axis tilt, where the software incorrectly reported a Z negative over-travel and another issue where the tool incorrectly retracted significantly past the retract plane.

Fixed issues with setting part position for a fifth axis articulating head with scales enabled that could occur if the MPG or jog keys were used to position the axis. Previous to this change, it was required to make an MDI move to the same position shown on the DRO before setting the part position so that it worked properly. When it was not working properly, the DRO would be off by a small amount (up to the lash). Another problem that was addressed with this change is that you now see the DRO go to the set position without requiring a return to the previous menu.

Fixed a problem when generating an engine block report where the system appeared to be locked up, but was stuck in some very long loop adding bad data to the reported .html file. A necessary condition for this problem to occur is having only one bank.

Fixed an issue where after running the B axis scale calibration, the previous job name would not be restored.

Implemented a feature to automatically, and without user intervention, eliminate positioning errors caused by varying loads on the A axis when home is set. When a 4th rotary axis labeled 'A' has scales enabled and the non-zero scale encoder input is a single-turn or multi-turn absolute type (BiSS), then this axis is treated as special when executing an M26 command. There are two parameters associated with such a special axis, one is machine parameter 265 (Rotary A Axis Scale Encoder Home Position) and the other is machine parameter 266 (Rotary A Axis Scale Encoder Sign Extension). Upon executing an M26, if P265 is zero, then the scale encoder position is read and stored in P265. If P265 is not zero when executing an M26, there is a check that the scale position is within 0.1 degrees of the previous recording (stored in P265) and then the P265 value is used as an offset to the zero position. If not within 0.1 degrees, a prompt is displayed and the user can decide whether to cancel out or set a new value to use in P265. P266 is set to one in the rare case that the scale encoder position at the home position is close to zero (within 0.1 degrees), and this will ensure that rollover effects are not a problem. This feature should work with 22-bit or 19-bit BiSS encoders connected to ENCEXP hardware or an ACDC logic board.

Modified the Set Level menu by removing the option for the 4th (A) axis.

Changed the prompt for setting level on the fifth (B) axis to indicate that calibration must be run.

Fixed an issue on a system with a triangular rotary scale (five axis B BiSS scale) where it was possible that small movements (< 0.002 degrees) near the level position appear incorrect. The fix was implemented in the way the tilt.tab file is generated from the artic-head-lut.txt file, i.e., to fix the anomaly on an existing system requires the leveling procedure to be rerun or the removing of two certain lines from the tilt.tab file. Also, when loading the tilt.tab file there is a check that the number of forward entries matches the number of backward entries and if not a warning prompt is displayed and the scales are disabled.

Autonomous digitizing setup saves the H10 and H11 offsets and checks them when loading a new setup. If H10/H11 has changed by 0.01 inches or more, then a warning is displayed. Also, there is another check that the difference between H10 and H11 is within 0.01 inches of D10/2, i.e., the probe tip radius. In the future, changes may be made to automatically recalculate the planes when there has been a change in H10/H11 offsets.

The Set Level function for the rotary (A) axis sets the G54 A axis position. If scales are enabled for the rotary axis, then the scale position is used to compute the desired motor position, otherwise the motor

encoder position is used. A running log of the changes is maintained in the "rotary-axis-scale-set-level-log.txt" file.

Autonomous digitizing: added a feature to allow a line (instead of a curve) interpolation of plane fills. This prompt will appear if one chooses an "interpolation" of plane angles instead of the "perpendicular" option. So now there are three ways to perform a plane fill operation: perpendicular curve, interpolated curve, and interpolated line.

Autonomous digitizing: added the "F5 Flip" function key feature that will appear after two passes on the top side of a two-sided patch. There is also an additional confirmation prompt displayed before actually stopping, moving out of port, and flipping to the other side. The check for whether to stop-and-flip is made after a point is successfully digitized, so after the function key is pressed it is possible for a delay in response if autonomous digitizing is in the process of heavy number crunching looking for a clear place to avoid collisions.

Autonomous digitizing checks that CSR is unlocked.

Fixed issue in autonomous digitizing where the backplot view was not correct after exiting the tool menu.

Fixed issue in autonomous digitizing where exiting the tool menu would prompt to save changes when no changes were made.

Change so that a transformed tool check is not performed if the fifth axis is labeled 'N'.

Autonomous digitizing will try to continue on if it detects an unexpected probe contact on an angle (anti-shanking) adjustment move if the DSP and mechanical inputs are clear.

Fixed problem with surface following where it would not output the surface if more than five axes were enabled.

PLC

Added the following system variables to allow the forcing of memory bits 1-80, that work in a similar manner to the ones for forcing outputs. Note that the forced state is implemented at the end of a PLC program execution pass, so these memory bits can still take on other values during the execution pass. Also, like other force and invert PLC IO system variables, when SV\_ENABLE\_IO is on, they can be toggled via CTRL\_ALT\_F while live PLC diagnostics are displayed and will affect machine parameters 931-935 (force on) and machine parameters 936-940 (force off).

SV\_FORCE\_ON\_MEM1\_16\_BITS

SV\_FORCE\_OFF\_MEM1\_16\_BITS

SV\_FORCE\_ON\_MEM17\_32\_BITS

SV\_FORCE\_OFF\_MEM17\_32\_BITS

SV\_FORCE\_ON\_MEM33\_48\_BITS

SV\_FORCE\_OFF\_MEM33\_48\_BITS

SV\_FORCE\_ON\_MEM49\_64\_BITS

SV\_FORCE\_OFF\_MEM49\_64\_BITS

SV\_FORCE\_ON\_MEM65\_80\_BITS

SV\_FORCE\_OFF\_MEM65\_80\_BITS

Added system variables to support skinning applications so that they have a hollow pipe data path down to the PLC without going through CNC11. For more information on the Skinning API, see the Centroid Dealer website.

SV\_SKINNING\_DATA\_W\_1 - SV\_SKINNING\_DATA\_W\_12

SV\_SKINNING\_DATA\_FW\_1 - SV\_SKINNING\_DATA\_FW\_11

SV\_SKINNING\_DATA\_DFW\_1 - SV\_SKINNING\_DATA\_DFW\_11

Added several system variables that let a PLC program refer to an axis instead of a drive number. This is a convenience for writing PLC programs that are more generic without writing a lot of extra code to handle axis remappings and label changes. For the variables below, the ? represents a valid axis label (XYZABCUVW).

SV\_?\_AXIS\_VALID

SV\_?\_AXIS\_DRIVE\_ONLINE

SV\_?\_AXIS\_FIBER\_OK

SV\_?\_AXIS\_POWERED

SV\_?\_AXIS\_DRIVE\_STATUS

SV\_?\_AXIS\_DRIVE\_TYPE

SV\_?\_AXIS\_DRIVE\_NUMBER

SV\_?\_AXIS\_DRIVE\_CONTROL

SV\_?\_AXIS\_METER and SV\_SPINDLE\_METER

SV\_AXIS\_LABEL\_1 - SV\_AXIS\_LABEL\_8 which return the ASCII numeric code for the axis label as specified in the machine configuration.

Added the following system variables that are related to AC/DC RPM mode:

SV\_RPM\_MODE\_SPEED\_REQUEST\_1 - SV\_RPM\_MODE\_SPEED\_REQUEST\_8

SV\_RPM\_MODE\_DIRECTION\_1 - SV\_RPM\_MODE\_DIRECTION\_8

SV\_RPM\_MODE\_AXIS\_ENABLE\_1 - SV\_RPM\_MODE\_AXIS\_ENABLE\_8

SV\_RPM\_MODE\_ENABLE\_1 - SV\_RPM\_MODE\_ENABLE\_8

SV\_RPM\_MODE\_ACTIVE\_1 - SV\_RPM\_MODE\_ACTIVE\_8

SV\_RPM\_MODE\_ZERO\_SPEED\_1 - SV\_RPM\_MODE\_ZERO\_SPEED\_8

Increased the maximum size of a PLC program to 16384 tokens (up from 6144 tokens).

Implemented user variable substitution in custom PLC message file (plcmg.txt). If the user variable references an axis label (#20101 - #20108), then it is replaced with the axis label character instead of the ASCII code numerical value.

Add SV\_PC\_MAXIMUM\_CSS\_SPEED which is the commanded value given in a G50 Sssss command on a Lathe. It is updated when in CSS mode when a spindle speed command is sent to MPU11.

The ADC inputs on the Optic Direct board are mapped into the PLC. There are 16 bits reserved for the ADC input on each drive, but the Optic Direct uses only 12. A value of 0 corresponds to full negative voltage and a value of 4095 represents full positive voltage, with 2048 representing zero voltage. Channel 1 is mapped to INP929-INP944, channel 2 to INP945-INP960, ..., channel 8 to INP1041-INP1056.

Misc changes and fixes

Added --show and --hide command line arguments to show and hide the CNC11 display. Intended to be used in skinning applications. For more information on skinning and the Skinning API, see the Centroid Dealer website.

Added machine parameter 79 "Paired Axes Resync Delay Time" that can be used to specify a delay in milliseconds between the release of E-stop and the enabling of the axes. If the parameter is a negative value, then a resync move will always display the CYCLE START prompt before executing motion.

The skinning related "loadparm.xml" handling will send the parameters to the PLC.

AC/DC drive firmware (ac1.hex): Removed Kg scaling since it was already scaled by CNC11.

AC/DC drive firmware (ac1.hex): Fixed BiSS encoder protocol start up to prevent jump if count was over 17 bits.

Fixed a cutter comp tolerance anomaly where a 3 segment "dog leg" would cause an extraneous inserted "arc tail switchback" to appear if the length of the middle segment of the "dog leg" was sufficiently small (less than 2.5 times positional tolerance).